

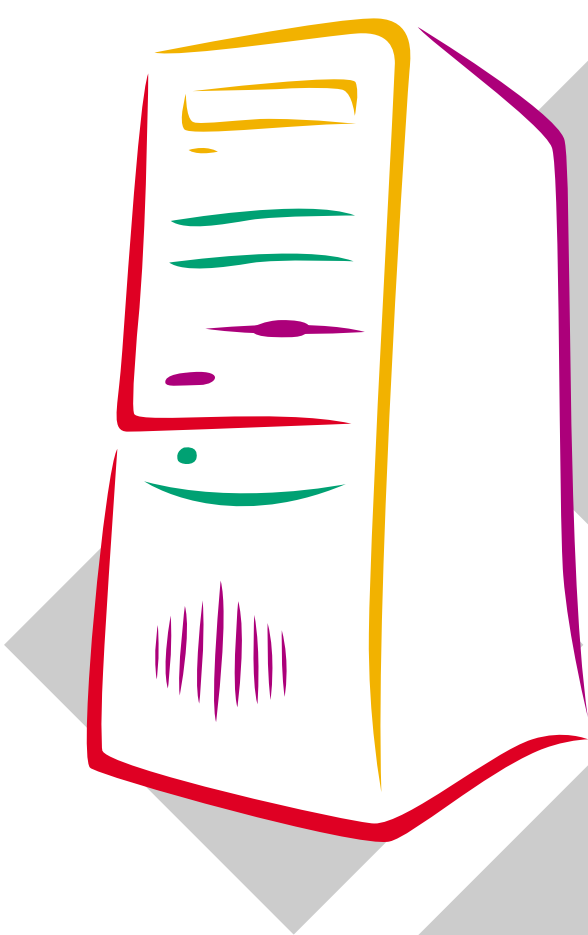

Aries/Centella

U S E R M A N U A L





System Manual

Copyright

Premio is a registered trademark of Premio Computer, Inc. All other brands and product names are trademarks or registered trademarks of their respective companies.

© 1997 by Premio Computer, Inc. All rights reserved.

Printed in Taiwan.

Centella, May 2000.

Disclaimers

Premio makes no representation or warranties, either expressed or implied, with respect to the contents of this publication and specifically disclaims the implied warranties of merchantability or fitness for a particular purpose. Premio shall not be liable for technical or editorial errors or omissions in this publication, or for incidental or consequential damages resulting from the furnishing, performance, or use of this publication. We reserve the right to revise this publication and to make changes from time to time in its contents without notification.

Contents

GETTING STARTED	1
Setting Up	2
Switches and Indicators	3
UPGRADING	5
Opening the System Unit	6
Installing an Expansion Card.....	7
Installing a Hard Drive	8
GETTING HELP	9
Troubleshooting	9
Monitor Does Not Work.....	9
Keyboard Does Not Work	10
Mouse Does Not Work.....	10
System Unit Problems	11
Hard Drive Problems.....	11
Technical Support	12
Premio on the Internet	12

APPENDIX..... 13

- Warranty Policy 13**
 - Service Under Warranty..... 14
 - Exclusions from Limited Warranty Programs..... 14
- FCC Standards 15**
- Important Safety Instructions 16**

Getting Started

Your Premio[®] system consists of three components:

- a mid-tower or desktop system unit
- a keyboard
- a mouse

Add your choice of monitor, and your system is ready to use.

Mid-tower system

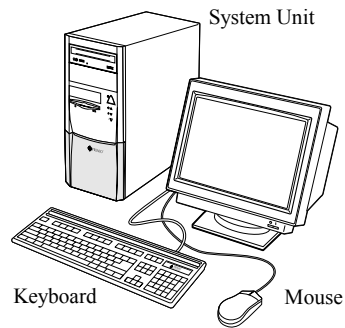

Desktop system

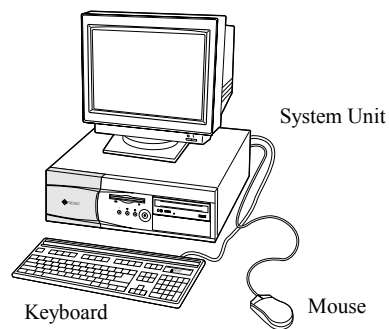

Setting Up

To set up your Premio system, simply connect your monitor, the mouse, the keyboard, and any additional components you want to use to the system unit.

Follow these easy steps:

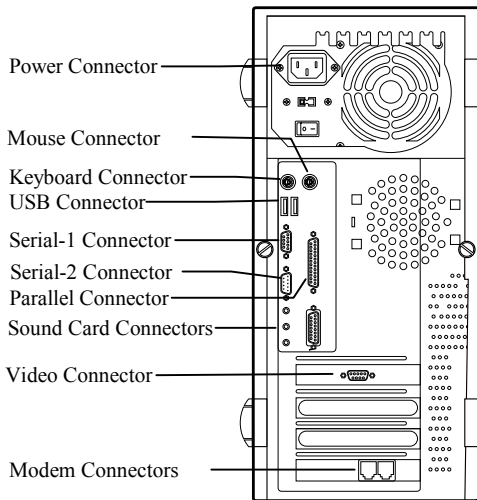

- 1** Attach your monitor's video cable to the video connector.
- 2** Attach the mouse cable to the mouse connector.
- 3** Attach the keyboard cable to the keyboard connector.
- 4** Attach the cables for any additional components, such as a printer, scanner, or modem, to the respective parallel, serial, or universal serial bus (USB) connector, as directed in the component's manual.
- 5** If your system is equipped for multimedia, attach your speakers and microphone to the sound card connectors.

- 6** Plug your monitor's power cord into a power outlet.
- 7** Attach the female end of the system power cord to the system unit's power connector, and then plug the other end of the cord into a power outlet.

Your Premio system is now ready to use. To start the system, turn on your monitor's power switch and then press the system power switch as shown on the next page.

Switches and Indicators

The system unit's front panel provides access to the CD-ROM and floppy drives, and to the system's switches and indicator lights.

The illustration below shows a mid-tower system. If you have a desktop system, turn to the illustration on the next page.

Mid-tower system

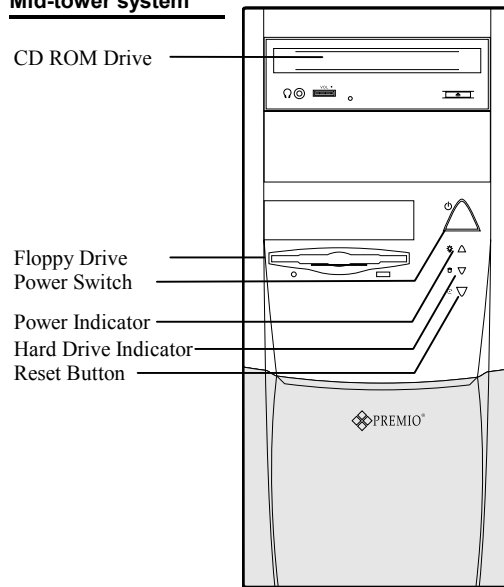

- The **CD-ROM drive** reads information on CDs.
- The **floppy drive** reads and writes information on diskettes.
- The **power switch** turns the system on and off.
- The **hard drive indicator** lights when the hard drive is in use.
- The **power indicator** lights when the system is on.
- The **reset button** restarts the system.

4 Premio System Manual

Desktop system

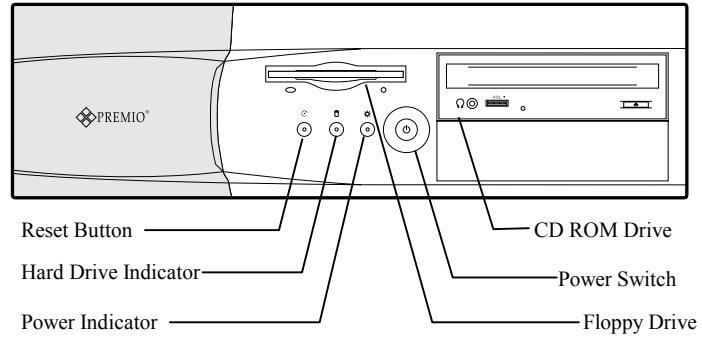

- The **reset button** restarts the system.
- The **hard drive indicator** lights when the hard drive is in use.
- The **power indicator** lights when the system is on.
- The **power switch** turns the system on and off.
- The **CD-ROM drive** reads information on CDs.
- The **floppy drive** reads and writes information on diskettes.

Upgrading

You can upgrade your Premio system with:

- Expansion cards
- More memory
- An additional hard drive

To install an upgrade, you must open the system unit. Before proceeding, read the important cautionary note below. Then follow the steps on the next page.

Caution! *Static discharge can cause permanent damage to internal electronic components of your computer. Always use the following precautions when working inside the system unit:*

- *Wear a grounding wrist strap (available at most electronics stores) when handling electronic components.*
- *Do not remove a component from its antistatic packaging until you are ready to install it.*
- *Keep one hand in contact with the metal system case.*

Opening the System Unit

Note: *Opening the system unit could affect your warranty. Check with the dealer where you purchased your system before opening the system unit.*

To open the system unit, follow these steps:

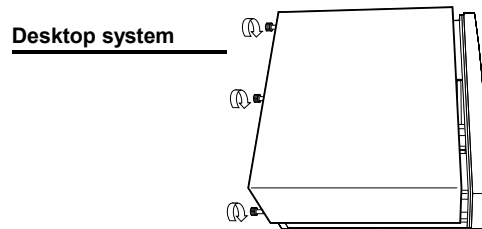
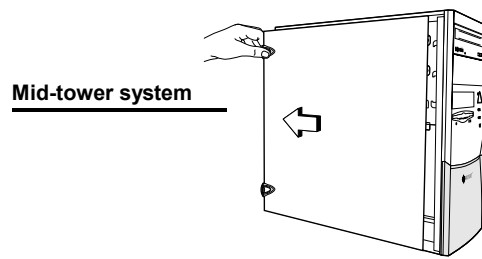

- 1** Turn off the system and unplug the power cord.
- 2** Remove the screws securing the side panel (mid-tower) or case (desktop) at the rear of the system unit.
- 3** Slide the side panel or case up and to the rear, and remove it.

Installing an Expansion Card

To install an expansion card, open the system unit as described on the previous page. Then follow these steps:

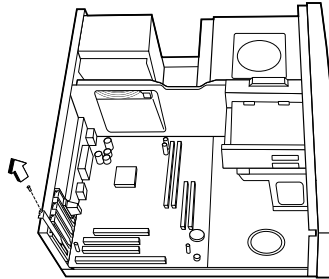

- 1** Remove the screw securing the slot bracket cover for the expansion slot you want to use. Save the screw to secure the expansion card.

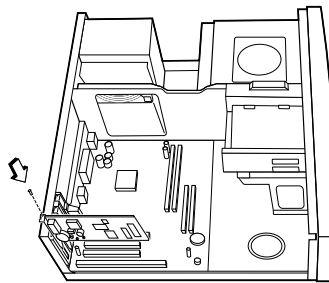

- 2** Insert the expansion card firmly into the slot, making sure it is seated completely.
- 3** Secure the card with the saved screw.

Installing a Hard Drive

To install a hard drive in your system, follow these steps:

- 1 Disconnect the hard drive cable and power connector.

Mid-tower system

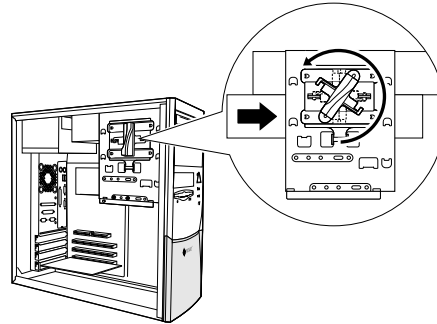

Desktop system

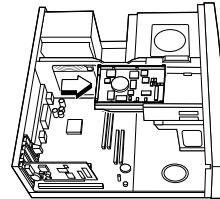

- 2 Remove the two screws securing the drive bay.
- 3 Slide the bay toward the rear of the system unit to remove it.
- 4 Insert the new drive into an open position in the bay and secure it with four screws.
- 5 Slide the bay back into the system unit and secure it with two screws.
- 6 Connect the cables.

Getting Help

Troubleshooting

Your Premio system is designed to provide years of trouble-free performance. If you have a problem with your system, first check the information in this section for a quick solution.

Monitor Does Not Work

If your monitor appears not to be working properly:

- Check that the monitor's power cable is securely attached to the monitor and to an outlet that is receiving power.
- Check that the monitor's video cable is securely attached to the monitor and to the system unit's video card connector.
- Check that the monitor's power switch is on.
- Adjust the monitor's brightness and contrast controls.
- If possible, substitute another monitor that is in good working order. If the substitute works, your monitor may need repair or replacement.

Keyboard Does Not Work

If the NumLock indicator in the upper right corner of the keyboard does not light when the system powers up, or the keyboard does not work:

- Check that the keyboard cable is securely attached to the system unit's keyboard connector.
- If possible, substitute another keyboard that is in good working order. If the substitute works, your keyboard may need replacement.

Mouse Does Not Work

If your mouse pointer does not move or moves erratically when you move the mouse:

- Check that the mouse cable is securely attached to the mouse connector on the system unit.
- Disassemble the mouse and clean the roller ball.

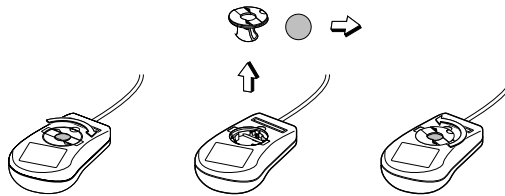

System Unit Problems

The fan inside the system unit should make a low, steady sound when operating properly. If the fan is totally silent:

- Check that the system power cord is securely attached to the back of the system unit and to a power outlet. Verify that the outlet has power.
- If possible, substitute another power cord that is in good working order. If the substitute works, replace your power cord.

If the fan makes excessive noise:

- Turn off the system, open the system unit case, and inspect the fan for any obstructions.
- Turn on the system and listen closely to the fan. If the noise comes from inside the fan housing, your power supply may need replacement.

Hard Drive Problems

Your hard drive should make a slight whirring sound when operating properly.

If the drive is totally silent:

- Turn off the system, open the system unit case, and check that the power cable between the power supply and the hard drive is securely attached at both ends. If it is, your hard drive may be defective.

If the hard drive makes excessive noise:

- Turn off the system, open the system unit case, and remove the hard drive power cable connector from the hard drive. Then turn the system back on. If the noise disappears, your hard drive may be defective.
- If you have more than one hard drive, repeat the same procedure for each drive.

Technical Support

You can contact Premio technical support at the following address:

Premio Computer, Inc.

918 Radecki Court

City of Industry, CA 91748

Telephone: 626.839.3100

Fax: 626.839.3191

Email: support@premiopc.com

Web page: <http://support.premiopc.com>

Premio on the Internet

Premio maintains a web page on the Internet with the latest information on Premio products, updated drivers, answers to common problems, a troubleshooting guide, and more. Visit our web page at:

<http://www.premiopc.com>

Appendix

Warranty Policy

Premio Computer, Inc. warrants its line of Premio[®] computer systems to be free from defects in material and workmanship for a specific warranted period as stated below, from the date of original purchase from Premio Computer, Inc. or a Premio Computer, Inc. authorized reseller. This warranty is contingent upon proper use of the product in question and does not cover products which have been modified or which have been subjected to unusual physical or electrical stress. Warranty for third party hardware and software, if any, is subject to the third party's warranty policy. Please refer to the following for length of warranty for Premio's product line.

Premio Product	Warranty
Complete Premio System with monitor	3 years parts and labor
Premio Barebone (with or without CPU)	2 years parts and labor
Premio Monitor	2 year parts and labor
Premio OEM Component (motherboard, speaker, case, keyboard, mouse, floppy drive, CD-ROM, etc.)	2 years parts and labor

Service Under Warranty

If this product fails to be in good working order during the warranty period (or specific period of time as noted above), Premio Computer, Inc. will, at its option, repair or replace the product. Repair parts and/or replacement products may be either new or reconditioned at Premio Computer Inc.'s discretion. The limited warranty does not include service or repair for damage from improper installation, abuse or modifications to the product not approved in writing by Premio Computer, Inc. Any service repair outside the scope of this limited warranty will be at Premio Computer, Inc.'s or its Authorized Service Provider's rates and terms in effect. This warranty is valid only within the United States, Puerto Rico, Canada, Mexico and South America.

Exclusions from Limited Warranty Programs

All other expressed and implied warranties for this product are hereby disclaimed. If this product is not in good working order as warranted above, Premio Computer's sole and exclusive remedy shall be repair or replacement as stated above. In no event will Premio Computer, Inc. be liable to the customer or any third party for any damages in excess of the purchase price of the product. This limitation applies to damages of any kind including any direct or indirect damages, lost profits, lost savings or other special, incidental or consequential damages. This holds true for situations even if Premio Computer, Inc. or an authorized Premio representative or dealer has been advised of the possibility of such damages or of any claim by another party. Some states do not allow the exclusion or limitation of incidental or consequential damages for some products, so the above limitation or exclusion may not apply to you. Premio Computer, Inc. authorized resellers and service providers/partners may be changed, added or deleted, without notice or liability. Premio Computer, Inc. disclaims any authorized resellers and service provider/partner to the program. This warranty gives you specific legal rights and you may also have other rights, which may vary from state to state.

FCC Standards

This equipment has been tested and found to comply with the limits for a Class B digital device, pursuant to Part 15 of the FCC Rules. These limits are designed to provide reasonable protection against harmful interference in a residential installation. This equipment generates, uses and can radiate radio frequency energy and, if not installed and used in accordance with the instructions, may cause harmful interference to radio communications. However, there is no guarantee that interference will not occur in a particular installation. If this equipment does cause harmful interference to radio or television reception, which can be determined by turning the equipment off and on, the user is encouraged to try to correct the interference by one or more of the following measures:

- Reorient or relocate the receiving antenna.
- Increase the separation between the equipment and receiver.
- Connect the equipment into an outlet on a circuit different from that to which the receiver is connected.
- Consult the dealer or an experienced radio/TV technician for help.

Important Safety Instructions

These instructions are provided by Underwriters Laboratories, Inc.

1. Read all of these instructions and save them for later reference.
2. Follow all warnings and instructions marked on the product.
3. Unplug this product from the wall outlet before cleaning. Do not use liquid or aerosol cleaners. Use a damp cloth for cleaning.
4. Do not use this product near water.
5. Do not place this product on an unstable cart, stand or table. The product may fall, causing serious damage to the product.
6. Slots and openings on the cabinet and the back or bottom are provided for ventilation. To ensure reliable operation of the product and to protect it from overheating, do not block or cover these openings. The openings should never be blocked by placing the product on a bed, sofa, rug or other similar surface. This product should never be placed near or over a radiator or heat register. This product should not be placed in a built-in installation unless proper ventilation is provided.
7. This product should be operated from the type of power source indicated on the marking label. If you are not sure of the type of power available, consult your dealer or local power company.
8. This product is equipped with a 3-wire grounding-type plug, a plug having a third (grounding) pin. This plug will only fit into a grounding-type power outlet. This is a safety feature. If you are unable to insert the plug into the outlet, contact your electrician to replace your obsolete outlet. Do not defeat the safety purpose of the grounding-type plug.
9. Do not allow anything to rest on the power cord. Do not locate this product where the cord will be walked on.
10. If an extension cord is used with this product, make sure that the total of the ampere ratings on the products plugged into the extension cord do not exceed the extension cord ampere rating. Also, make sure that the total of all products plugged into the wall outlet does not exceed 15 amperes.
11. Never push objects of any kind into this product through cabinet slots as they may touch dangerous voltage points or short out parts

that could result in a risk of fire or electric shock. Never spill liquid of any kind on the product.

12. Except as explained elsewhere in this manual, don't attempt to service this product yourself. Opening and removing those covers that are marked "Do Not Remove" may expose you to dangerous voltage points or other risks. Refer all servicing on those compartments to service personnel.
13. Unplug this product from the wall outlet and refer servicing to qualified service personnel under the following conditions:
 - A. When the power cord or plug is damaged or frayed.
 - B. If liquid has been spilled into the product.
 - C. If the product has been exposed to rain or water.
 - D. If the product does not operate normally when the operating instructions are followed. Adjust only those controls that are covered by the operating instructions since improper adjustment of other controls may result in damage and will often require extensive work by a qualified technician to restore the product to normal operation.
 - E. If the product has been dropped or the cabinet has been damaged.
 - F. If the product exhibits a distinct change in performance, indicating a need for service.

Introduction

1

The MS-6368 Micro-ATX mainboard is a high-performance computer mainboard based on VIA Apollo PLE133 (ProMedia II) chipset and designed for the Intel® Celeron™ or Pentium !!! (FC-PGA) processor for inexpensive business/personal desktop markets.

The Apollo PLE133 chipset consists of the VT8601A North Bridge controller and the VT82C686A/686B South Bridge controller. The VT8601A integrates rich AGP2X graphics capabilities for 2D/3D software and internet multimedia applications. It supports Intel® Pentium !!!, Celeron™ and VIA Cyrix® III running at a variety of FSB frequencies from 66 to 133 MHz; and provides bandwidth and performance for internet and 3D graphics needs by supporting advanced memory technologies PC133 SDRAM and VC133 RAM (Virtual Channel RAM) up to 1.0GB.

The VIA® VT82C686A/686B Super I/O PCI integrated Peripheral Controller (PSIPC) includes PCI-to-ISA bridge controller, 10/100 BaseT Ethernet controller, AC'97 audio and MC'97 modem (for AMR slot). In addition, it supports dual bus-master IDE with Ultra DMA 33/66 (686B also supports Ultra DMA100), four USB ports, system hardware monitoring and enhanced power management capabilities.

The Apollo PLE133 chipset allows the MS-6368 mainboard to meet specific needs of internet multimedia and 3D graphics applications.

This chapter includes the following topics:

Mainboard Specifications	1-2
Mainboard Layout	1-4
Quick Components Guide	1-5
Key Features	1-6
MSI Special Features	1-7

Mainboard Specification

CPU

- Support Socket 370 for Intel® Celeron™ /Pentium !!! (FC-PGA) processor and VIA Cyrix® III processor
- Support CPU frequencies at 333/350/400/450/500/533/550/667/700/750/800/850/933/950MHz, 1GHz or above

Chipset

- VIA® VT8601A chipset (510 BGA)
 - FSB @ 133MHz
 - Integrated Trident Blade 2D/3D video accelerator
 - PCI advanced high performance memory controller
 - Support PC100/133 SDRAM, VCM & ESDRAM technology
- VIA® VT686A/686B chipset (352 BGA)
 - Enhanced Power Management Features
 - Integrated Super I/O (FDC, LPT, COM 1/2 and IR)
 - Dual bus Master IDE Ultra DMA 33/66 (686B supports up to Ultra DMA 100)
 - Integrated Hardware Soundblaster
 - Direct Sound AC97 Audio
 - ACPI

Clock Generator

- Support 66/100/133MHz clocks

Main Memory

- Support four memory banks using 168-pin unbuffered DIMM
- Support a maximum memory size of 1GB (256 MB DRAM technology)
- Support 3.3V SDRAM DIMM

Slots

- One AMR (Audio Modem Riser) slot (for PCB 1.0 only)
- One CNR (Communication Network Riser) slot (for PCB 2.0 only)
- Three 32-bit Master PCI Bus slots
- One ISA slot (for PCB 1.0 only)
- Support 3.3V/5V PCI bus Interface

On-Board IDE

- An IDE controller on the VIA® VT82C686A/686B chipset provides IDE HDD/CD-ROM with PIO, Bus Master and Ultra DMA 33/66 operation modes (686B can support up to Ultra DMA 100)
- Can connect up to four IDE devices

Audio

- Audio controller integrated in 686A/686B chipset
- Software audio codec ALC100
 - Onboard Front Audio Pin Header (optional)

Network

- Realtek 8139C

On-Board Peripherals

- On-Board Peripherals include:
 - 1 floppy port supports 2 FDD with 360K, 720K, 1.2M, 1.44M and 2.88Mbytes
 - 2 serial ports (COM1 + COM2) (COM2 is optional)
 - 1 parallel port supporting SPP/EPP/ECP mode
 - 4 USB ports (2 rear connectors and 1 USB front pin header- 2 ports)
 - 1 IrDA connector for SIR/CIR/FIR/ASKIR/HPSIR
 - 1 VGA port
 - 1 Audio/Game port

BIOS

- The mainboard BIOS provides “Plug & Play” BIOS which detects the peripheral devices and expansion cards of the board automatically.
- The mainboard provides a Desktop Management Interface (DMI) function which records your mainboard specifications.

Dimension

- Micro-ATX Form Factor: 24.3cm (L) x 20.3cm (W)

Mounting

- 6 mounting holes

Mainboard Layout

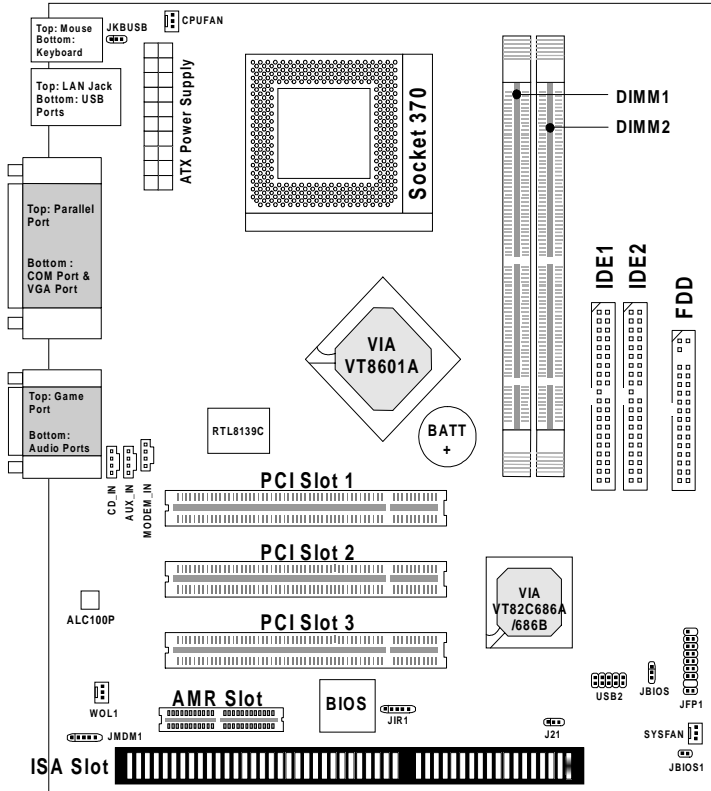

**MS-6368 Micro-ATX VA Mainboard
(PCB 1.0)**

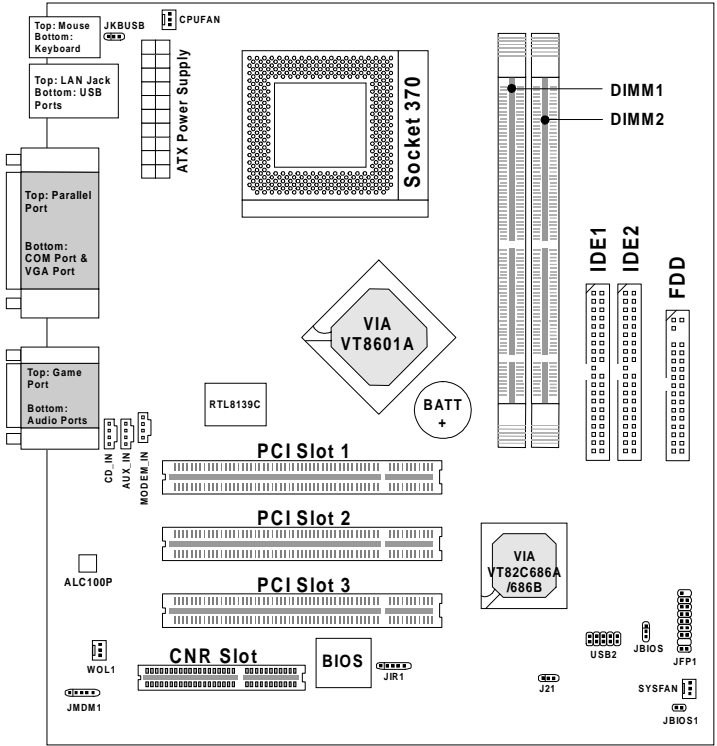

**MS-6368 Micro-ATX VA Mainboard
(PCB 2.0)**

Chapter 1

Quick Components Guide

Component	Function	Reference
DIMM 1~2	Installing memory modules	See p. 2-4~2-5
Socket 370	Installing CPU	See p. 2-2~2-3
CPUFAN	Connecting to CPUFAN	See p. 2-18
SYSFAN	Connecting to SYSFAN	See p. 2-18
ATX Power Supply	Installing power supply	See p. 2-6
IDE1 & IDE2	Connecting to IDE hard disk drive	See p. 2-14
FDD1	Connecting to floppy disk drive	See p. 2-13
USB2	Connecting to USB interfaces	See p. 2-13
PCI Slot 1~3	Installing expansion cards	See p. 2-25
ISA Slot	Installing ISA cards (PCB 1.0 only)	See p. 2-26
AMR Slot	Installing expansion cards (PCB 1.0 only)	See p. 2-25
CNR Slot	Installing expansion cards (PCB 2.0 only)	See p. 2-26
JFP1	Connecting to the case	See p. 2-15
JMDM1	Connecting to a modem card	See p. 2-17
WOL1	Connecting to an LAN card	See p. 2-17
JIR1	Connecting to IrDA infrared module	See p. 2-20
JBIOS	Clearing CMOS data	See p. 2-22
JKBUSB & J21	Setting keyboard wake-up function	See p. 2-23
JBIOS1	Setting BIOS flash function	See p. 2-22

Key Features

- Microsoft® PC99 compliant
- T.O.P Tech™ - Thermal Overheat Protection Technology
- PC Alert™ III system hardware monitor
- CPU: Socket 370 for Intel® Celeron™/Pentium !!! Processor
- Micro-ATX Form Factor
- Clock: 66/100/133MHz
- Audio integrated in chipset
- Memory: 2 SDRAM DIMMs
- LAN Wake up Function
- Modem (External/Internal) Ring Wake up Function
- I/O: 2 serial ports, 1 parallel port, 4 USB ports, 1 floppy port, 1 IrDA connector, 1 Audio/Game port
- Slot: 1 ISA slot, 1 AMR slot, 3 PCI slots (for PCB 1.0)
- Slot: 1 CNR slot, 3 PCI slots (for PCB 2.0)

MSI Special Features

PC Alert™ III

The PC Alert™ III is a utility you can find in the CD-ROM. The utility is just like your PC doctor that can detect the following PC hardware status during real time operation:

- * monitor CPU & system temperature
- * monitor fan speed
- * monitor system voltage
- * monitor chassis intrusion

If one of the items above is abnormal, the program main screen will be immediately shown on the screen, with the abnormal item highlighted in red. This will continue to be shown until user disables the warning.

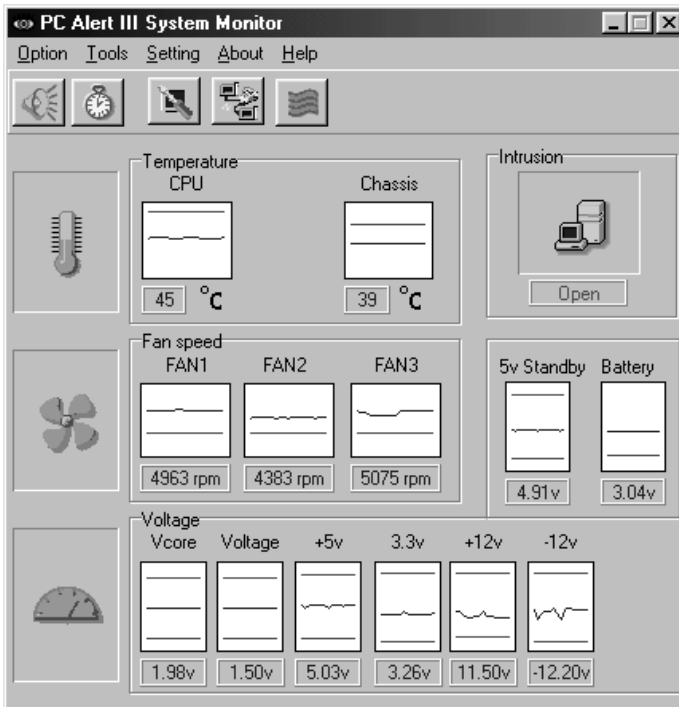



Features:

- Network Management
 - Monitoring & remote control
- Basic System Utilities
 - Scandisk & Defragment to maintain your HDD
- 3D Graphics Design
 - Enables a more friendly user interface
- Software Utilities
 - SoftCooler Optimized Cooling
 - Doctor Y2K Diagnoses Y2K problems
 - BusRacing function adjusts F.S.B under Windows 95/98
 - MoSpeed Speeds up your modem transmission

Hardware Setup

2

This chapter provides you with the information about hardware setup procedures. While doing the installation, be careful in holding the components and follow the installation procedures. For some components, if you install them in the wrong orientation, the components will not work properly.

Use a grounded wrist strap before handling computer components. Static electricity may damage the components.

This chapter contains the following topics:

Central Processing Unit (CPU)	2-2
Memory Installation	2-4
Power Supply	2-6
Back Panel	2-7
Connectors	2-13
Jumpers	2-21
Slots	2-24

Central Processing Unit: CPU

The mainboard supports Intel® Celeron™ and Pentium !!! processor. The mainboard uses a CPU socket called Socket 370 for easy CPU installation. Make sure the CPU has a Heat Sink and a cooling fan attached on top to prevent overheating. If you do not find the Heat Sink and cooling fan, contact your dealer or purchase and install them before turning on the computer.

CPU Installation Procedures

1. Pull the lever sideways away from the socket. Then, raise the lever up to a 90-degree angle.
2. Locate Pin 1 in the socket and look for the mark or cut edge on the corner of CPU. Align Pin 1 with the mark/cut edge of CPU and then insert the CPU.
3. Press the lever down to complete the installation.

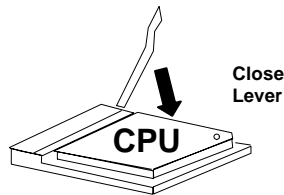
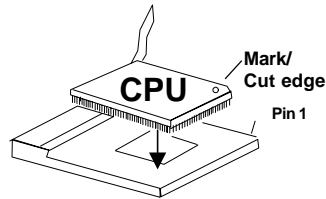
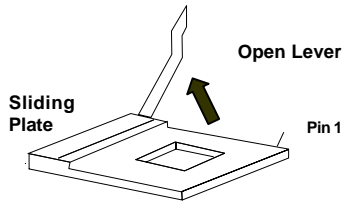

WARNING!

Overheating will seriously damage the CPU and system, always make sure the cooling fan can work properly to protect the CPU from overheating.

CPU Core Speed Derivation Procedure

The mainboard can automatically set the CPU Host Bus Frequency Clock.

If	<u>CPU Clock</u>	=	100MHz
	<u>Core/Bus ratio</u>	=	7
then	<u>CPU core speed</u>	=	<u>Host Clock</u> x <u>Core/Bus ratio</u>
		=	100MHz x 7
		=	700MHz

Memory Installation

The mainboard provides 2 slots for 168-pin, 3.3V SDR DIMM with 4 memory banks. To operate properly, at least one DIMM module must be installed.

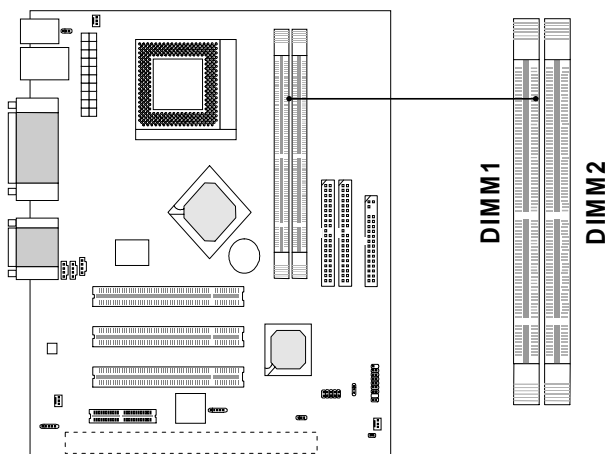

The SDRAM Addressing & Size

DRAM Tech.	DRAM Density & Width	DRAM Addressing	Address Size		MB/DIMM	
			Row	Column	Single no. Side(S) pcs.	Double no. Side(D) pcs.
16M	1Mx16	ASYM	11	8	8MBx4	16MBx8
	2Mx8	ASYM	11	9	16MBx8	32MBx16
	4Mx4	ASYM	11	10	32MB	64MB
64M	2Mx32	ASYM	11	9	32MBx2	64MBx4
	2Mx32	ASYM	12	8	16MBx2	32MBx4
	4Mx16	ASYM	11	10	32MB	64MB
	4Mx16	ASYM	13	8	32MB	64MB
	8Mx8	ASYM	13	9	64MB	128MB
	16Mx4	ASYM	13	10	128MB	256MB
64M	2Mx32	ASYM	12	8	16MB	32MB
	4Mx16	ASYM	13	8	32MB	64MB
	8Mx8	ASYM	13	9	64MB	128MB
	16Mx4	ASYM	13	10	128MB	256MB

Module Installation Procedures

You can install single sided or double sided 168-pin DIMMs into DIMM slots according to your needs.

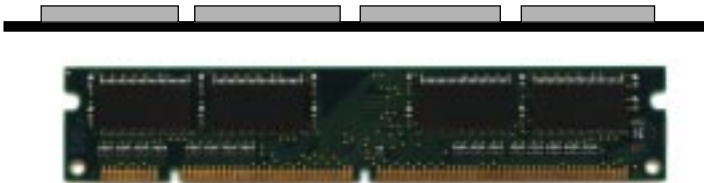

Single Sided DIMM

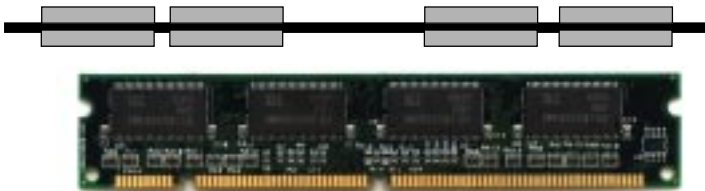

Double Sided DIMM

1. The DIMM slot has 2 Notch Keys “VOLT and DRAM”, so the DIMM memory module can only fit in one direction.
2. Insert the DIMM memory module vertically into the DIMM slot. Then push it in.

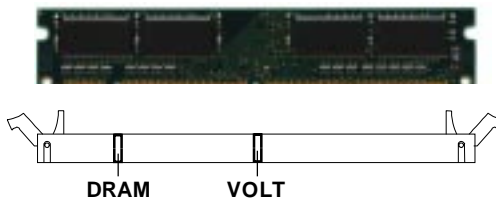

3. The plastic clips at sides of the DIMM slot will automatically close.

Power Supply

The mainboard supports ATX power supply for the power system. Before connecting to the power supply, always make sure that all components are installed properly and no damage will be caused.

ATX 20-Pin Power Supply

This connector allows you to connect to an ATX power supply. To connect to the ATX power supply, make sure the power supply connector is installed in the right orientation and the pins are aligned. Then push down the power supply connector firmly into the power connector on the mainboard.

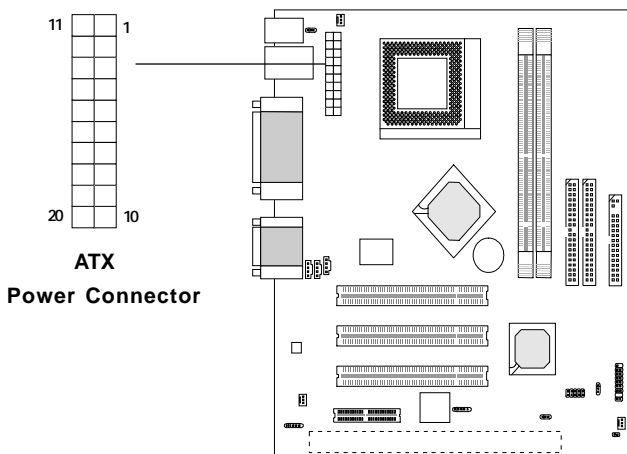

PIN	SIGNAL	PIN	SIGNAL
1	3.3V	11	3.3V
2	3.3V	12	-12V
3	GND	13	GND
4	5V	14	PS_ON
5	GND	15	GND
6	5V	16	GND
7	GND	17	GND
8	PW_OK	18	-5V
9	5V_SB	19	5V
10	12V	20	5V

Back Panel

The Back Panel provides the following connectors:

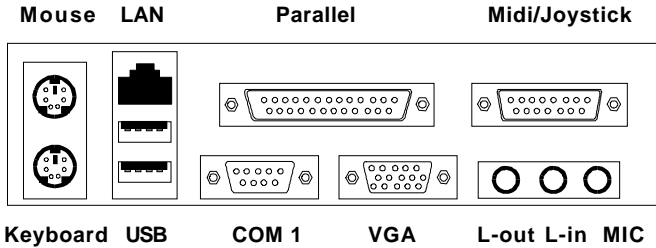

Mouse Connector

The mainboard provides a standard PS/2[®] mouse mini DIN connector for attaching a PS/2[®] mouse. You can plug a PS/2[®] mouse directly into this connector.

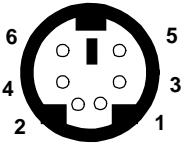

PS/2 Mouse (6-pin Female)

Pin Definition		
PIN	SIGNAL	DESCRIPTION
1	Mouse DATA	Mouse DATA
2	NC	No connection
3	GND	Ground
4	VCC	+5V
5	Mouse Clock	Mouse clock
6	NC	No connection

Chapter 2

Keyboard Connector

The mainboard provides a standard PS/2® keyboard mini DIN connector for attaching a PS/2® keyboard. You can plug a PS/2® keyboard directly into this connector.

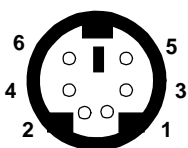

PS/2 Keyboard (6-pin Female)

Pin Definition

PIN	SIGNAL	DESCRIPTION
1	Keyboard DATA	Keyboard DATA
2	NC	No connection
3	GND	Ground
4	VCC	+5V
5	Keyboard Clock	Keyboard clock
6	NC	No connection

USB Connectors

The mainboard provides a UHCI (Universal Host Controller Interface) Universal Serial Bus root for attaching USB devices such as keyboard, mouse or other USB-compatible devices. You can plug the USB device directly into the connector.

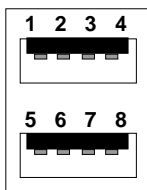

USB Ports

USB Port Description

PIN	SIGNAL	DESCRIPTION
1	VCC	+5V
2	-Data 0	Negative Data Channel 0
3	+Data0	Positive Data Channel 0
4	GND	Ground
5	VCC	+5V
6	+Data 1	Positive Data Channel 1
7	-Data 1	Negative Data Channel 1
8	GND	Ground

Parallel Port Connector

The mainboard provides a 25-pin female centronic connector for LPT. A parallel port is a standard printer port that supports Enhanced Parallel Port (EPP) and Extended Capabilities Parallel Port (ECP) mode.

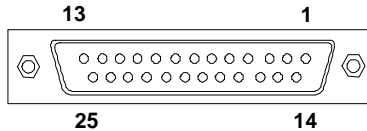

Pin Definition

PIN	SIGNAL	DESCRIPTION
1	STROBE	Strobe
2	DATA0	Data0
3	DATA1	Data1
4	DATA2	Data2
5	DATA3	Data3
6	DATA4	Data4
7	DATA5	Data5
8	DATA6	Data6
9	DATA7	Data7
10	ACK#	Acknowledge
11	BUSY	Busy
12	FE	Paper End
13	SELECT	Select
14	AUTO FEED#	Automatic Feed
15	ERR#	Error
16	INIT#	Initialize Printer
17	SLIN#	Select In
18	GND	Ground
19	GND	Ground
20	GND	Ground
21	GND	Ground
22	GND	Ground
23	GND	Ground
24	GND	Ground
25	GND	Ground1

Chapter 2

Serial Port Connector: COM 1

The mainboard has two 9-pin male DIN connectors for serial port COM

1. You can attach a serial mouse or other serial devices.

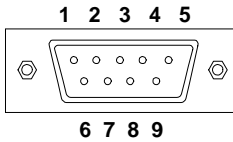

9-Pin Male DIN Connectors

Pin Definition

PIN	SIGNAL	DESCRIPTION
1	DCD	Data Carry Detect
2	SIN	Serial In or Receive Data
3	SOUT	Serial Out or Transmit Data
4	DTR	Data Terminal Ready)
5	GND	Ground
6	DSR	Data Set Ready
7	RTS	Request To Send
8	CTS	Clear To Send
9	RI	Ring Indicate

VGA DB 15 Pin Connector

The mainboard provides one DB 15-pin female connector to connect a VGA monitor.

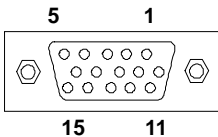

DB 15-Pin Female Connector

Pin Definition

Analog Video Display Connector (DB-15S)	
PIN	SIGNAL DESCRIPTION
1	Red
2	Green
3	Blue
4	Not used
5	Ground
6	Ground
7	Ground
8	Ground
9	Not used
10	Ground
11	Not used
12	SDA
13	Horizontal Sync
14	Vertical Sync
15	SCL

Joystick/Midi Connectors

You can connect a joystick or game pad to this connector.

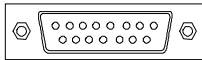

Audio Port Connectors

Line Out is to connect speakers or headphones. **Line In** is a connector for external CD player, Tape player or other audio devices. **Mic** is used to connect to a microphone.

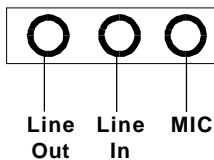

Chapter 2

LAN Jack (RJ-45)

The mainboard provides one standard RJ-45 jack for connection to Local Area Network (LAN). You can connect a network cable to the LAN jack.

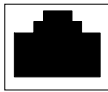

LAN RJ-45 Jack

Pin Definition

PIN	SIGNAL	DESCRIPTION
1	RDN	Receive Differential Pair
2	RDP	Receive Differential Pair
3	GND	Ground
4	GND	Ground
5	GND	Ground
6	GND	Ground
7	TDN	Transmit Differential Pair
8	TDP	Transmit Differential Pair

Connectors

The mainboard provides connectors to connect to FDD, IDE HDD, IDE RAID HDD, case, modem, LAN, USB Ports, IR module and CPU/Power Supply/System FAN.

Floppy Disk Drive Connector: FDD1

The mainboard provides a standard floppy disk drive connector that supports 360K, 720K, 1.2M, 1.44M and 2.88M floppy disk types.

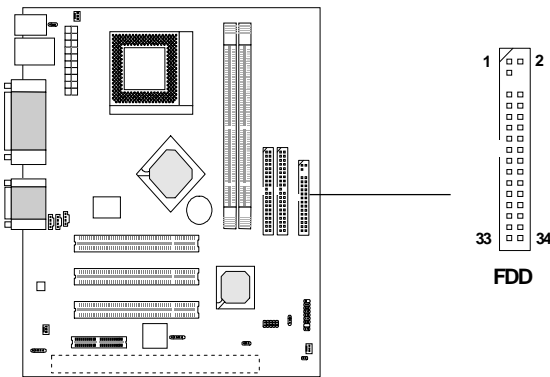

USB Front Panel Connector: USB2

The mainboard provides one Front USB (Universal Serial Bus) pin header that allows you to connect two optional USB ports for Front Panel.

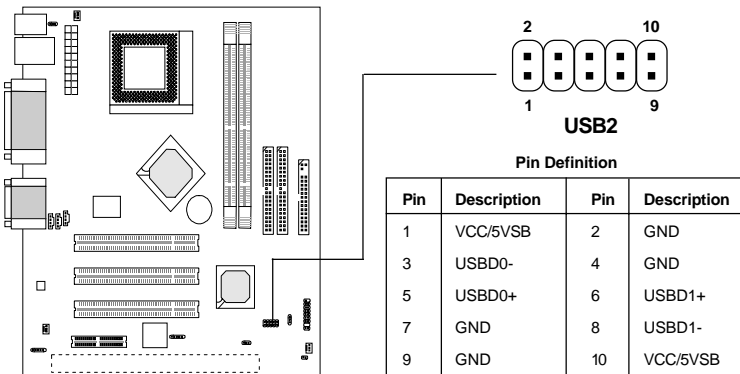

Chapter 2

Hard Disk Connectors: IDE1 & IDE2

The mainboard uses an IDE controller on the VIA® VT82C686A chipset that provides PIO mode 0-4, Bus Master, and Ultra DMA 33/66 modes. It has two HDD connectors IDE1 (Primary) and IDE2 (Secondary). You can connect up to four hard disk drives, CD-ROM or 120MB Floppy to IDE1 and IDE2.

IDE1 (Primary IDE Connector)

- The first hard disk drive should always be connected to IDE1. You can connect a Master and a Slave drive to IDE1.

IDE2 (Secondary IDE Connector)

- You can connect a Master and a Slave drive to IDE2.

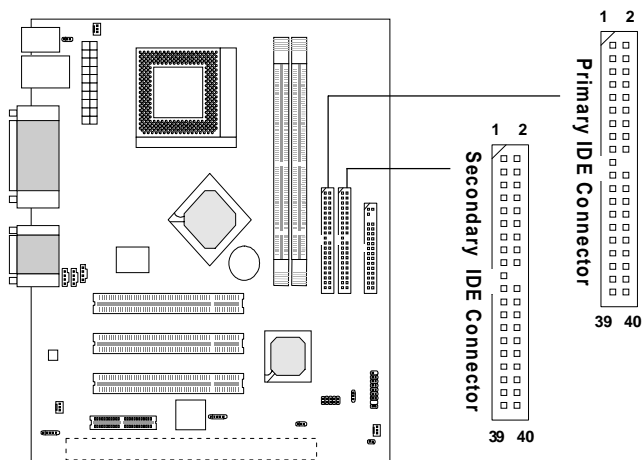

TIP:

If you install two hard disks on cable, you must configure the second drive to Slave mode by setting its jumper. Refer to the hard disk documentation supplied by hard disk vendors for jumper setting instructions.

Case Connector: JFP1

The case connector block JFP1 allows you to connect to the Power Switch, Reset Switch, Keylock, Speaker, Power LED, and HDD LED on the case.

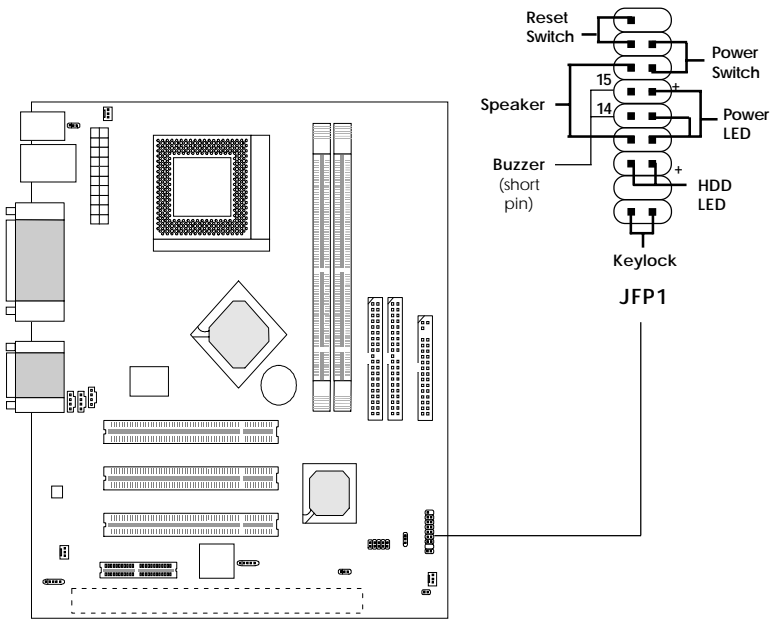

Chapter 2

Power Switch

Connect to a 2-pin push button switch. Pressing this button can turn the system power on or off.

Reset Switch

Reset switch is used to reboot the system rather than turning the power ON/OFF. Avoid rebooting while the HDD LED is lit. You can connect the Reset switch from the system case to this pin.

Power LED

The Power LED is lit while the system power is on. You can connect the Power LED from the system case to this pin. When the system enters the suspend mode, the Power LED will blink.

Speaker

Speaker from the system case is connected to this pin.

If on-board Buzzer is available, then:

Short pin 14-15: On-board Buzzer Enabled.

Open pin 14-15: On-board Buzzer Disabled.

HDD LED

HDD LED shows the activity of a hard disk drive. Avoid turning the power off while the HDD led is lit. You can connect the HDD LED from the system case to this pin.

Keylock

Keylock allows you to disable the keyboard for security purpose. You can connect the keylock to this connector.

Wake On Ring Connector: JMDM1

This connector allows you to connect to a modem card with Wake On Ring function. The connector will power up the system when a signal is received through the modem card.

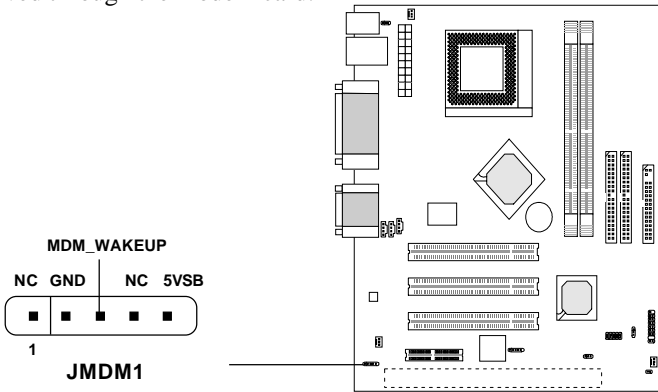

Wake On LAN Connector: WOL1

This connector allows you to connect to a LAN card with Wake On LAN function. You can wake up the computer via remote control through a local area network.

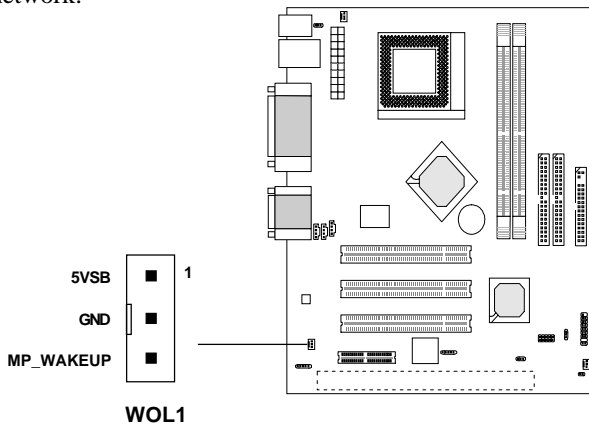

Fan Power Connectors: CPUFAN/SYSFAN

The CPUFAN (processor fan) and SYSFAN (system fan) support system cooling fan with +12V. It supports three-pin head connector. When connecting the wire to the connectors, always take note that the red wire is the positive and should be connected to the +12V, the black wire is Ground and should be connected to GND. If the mainboard has a System Hardware Monitor chipset on-board, you must use a specially designed fan with speed sensor to take advantage of the CPU fan control.

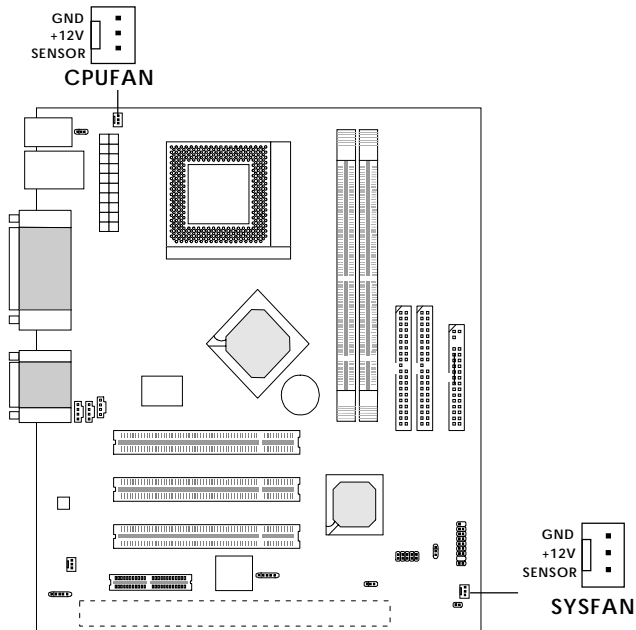

Note:

1. Always consult the vendor for proper CPU cooling fan.
2. CPU Fan supports the fan control. You can install the PC Alert utility that will automatically control the CPU Fan speed according to the actual CPU temperature.

CD-In Connector: CD_IN

The connector is for CD-ROM audio connector.

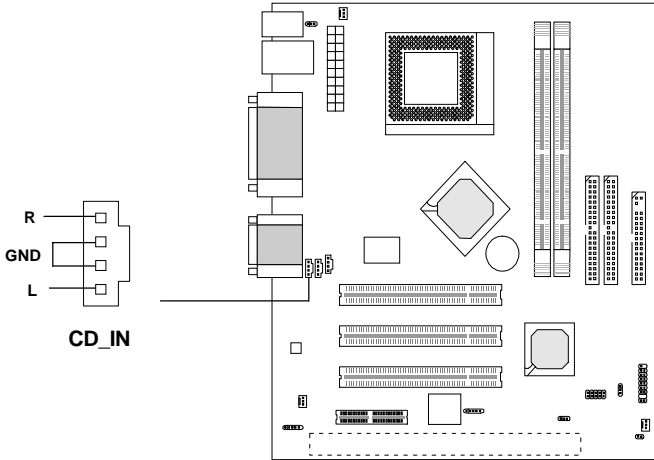

Aux Line-In Connector: AUX_IN

The connector is for DVD add-on card with Line-in connector.

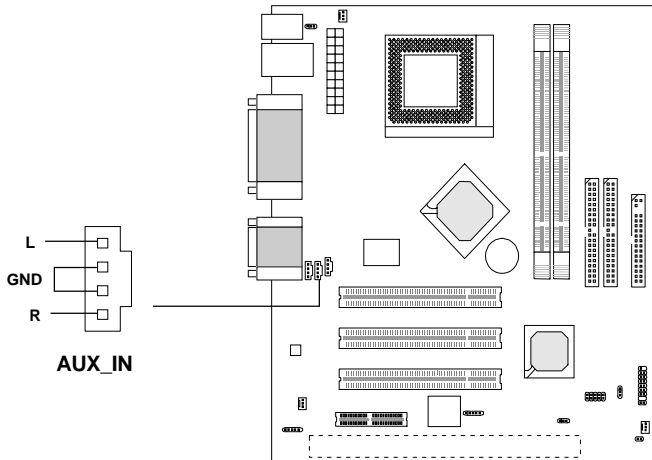

Modem-In Connector: MODEM_IN

The connector is for modem with internal audio connector.

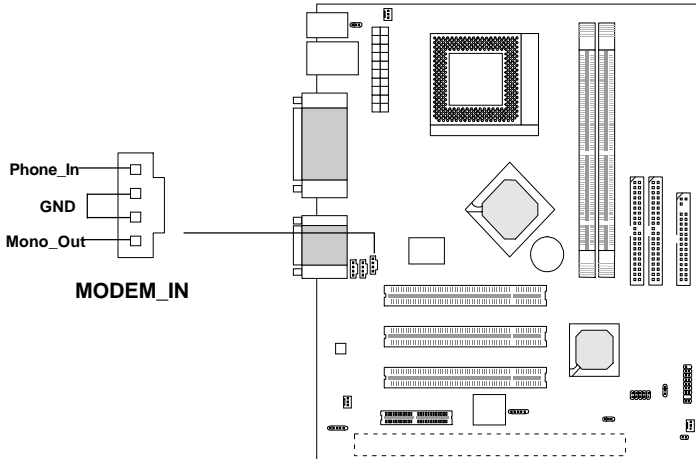

IrDA Infrared Module Connector: JIR1

This connector allows you to connect to an IrDA Infrared module. You must configure the setting through the BIOS setup to use the IR function.

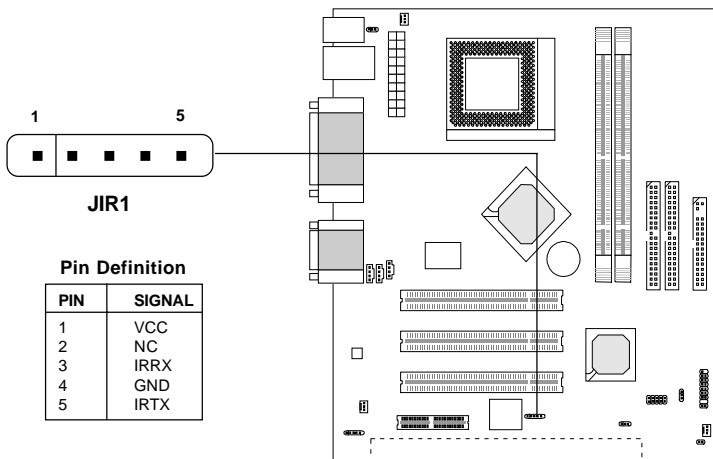



Jumpers

The motherboard provides the following jumpers for you to set the computer's function. This section describes how to change your motherboard's function through the use of jumpers.

Clear CMOS Jumper: JBIOS

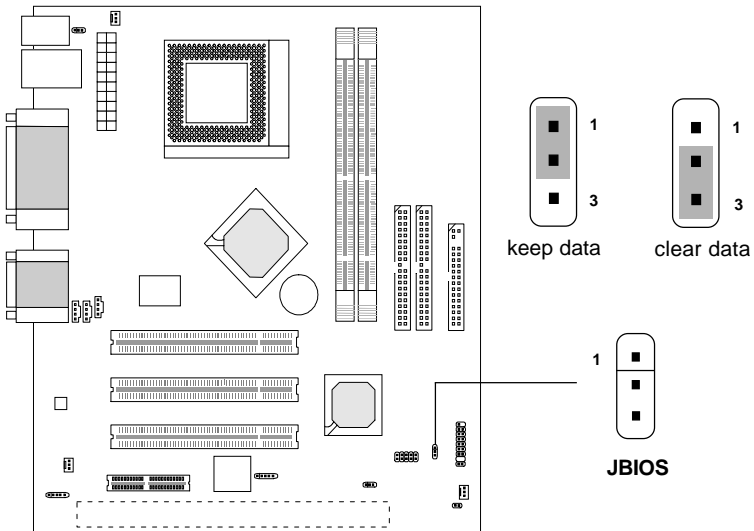
There is a CMOS RAM on board that has a power supply from external battery to keep the data of system configuration. With the CMOS RAM, the system can automatically boot OS every time it is turned on. The battery has long life time for at least 5 years. If you want to clear the system configuration stored in the CMOS RAM, use the JBIOS (Clear CMOS Jumper) to clear data. Follow the instructions below to clear the data:





WARNING! You can clear CMOS by shorting 2-3 pin while the system is off. Then return to 1-2 pin position. Avoid clearing the CMOS while the system is on; it will damage the mainboard.

Chapter 2

BIOS Flash Jumper: JBIOS1

The jumper is used to lock or unlock the BIOS Flash/Write function. The jumper should be unlocked when flashing/programming the BIOS.

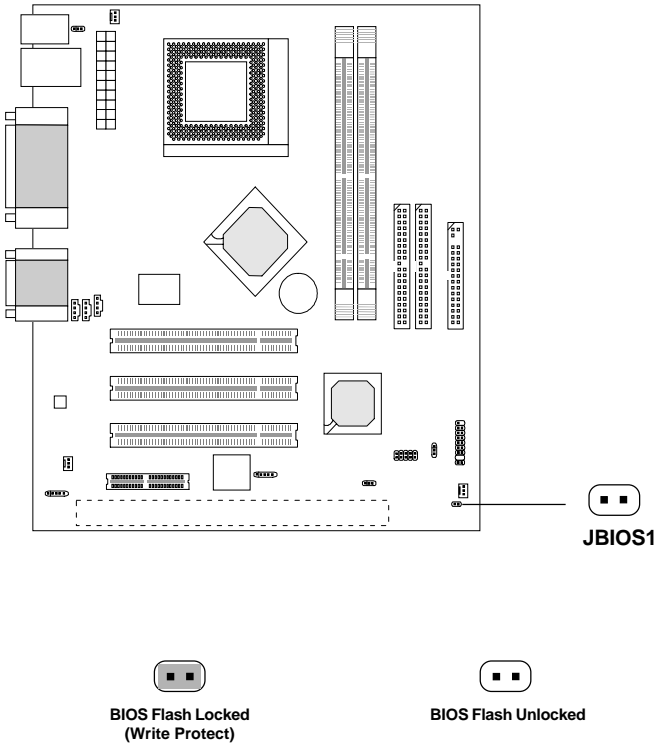

USB Keyboard Wake-up Jumpers: JKBUSB & J21

The JKBUSB/J21 jumpers are used to set USB keyboard wake-up function. (Please note JKBUSB is for USB rear ports and J21 is for USB front pin header: USB2) To use the function, you should also go to BIOS to enable the USB keyboard wake-up (power on) function.

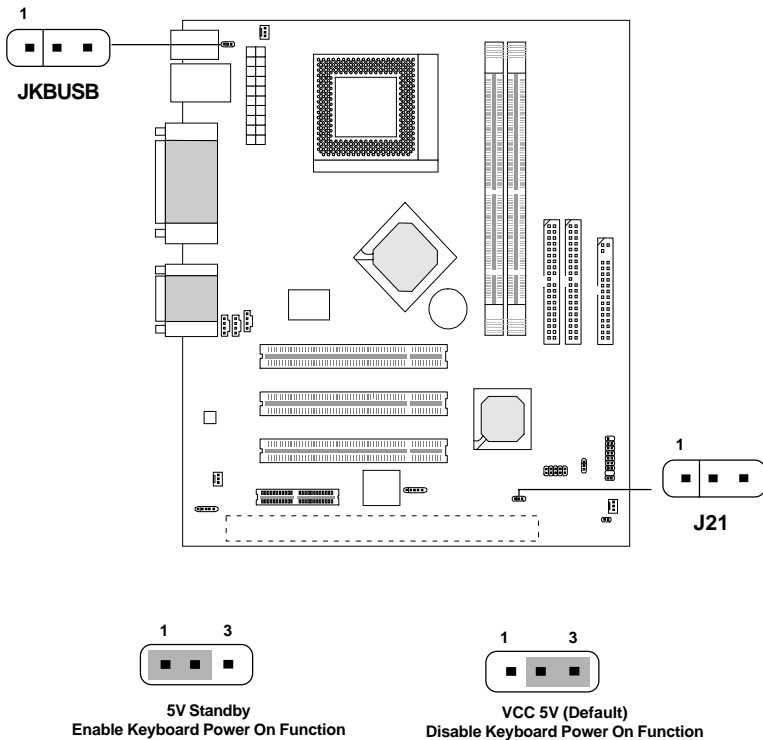

Note: To be able to use this function, you need a power supply that provides enough power for this feature. (Power supply with 750mA 5V Stand-by)

Slots

MS-6368 provides two models (PCB 1.0 and PCB 2.0) that have different slots. PCB 1.0 provides three 32-bit Master PCI Bus Slots, one AMR slot and one ISA slot while PCB 2.0 provides three 32-bit Master PCI Bus Slots and one CNR slot.

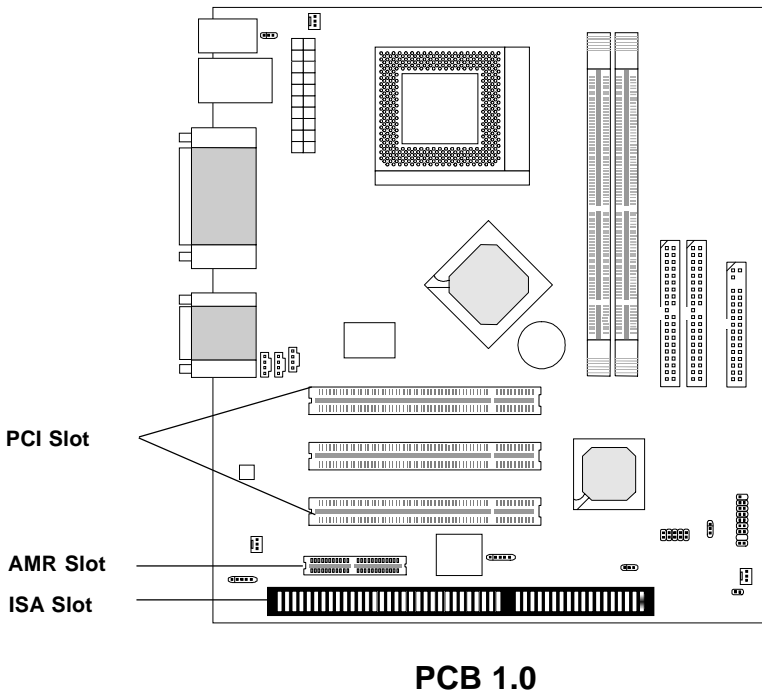

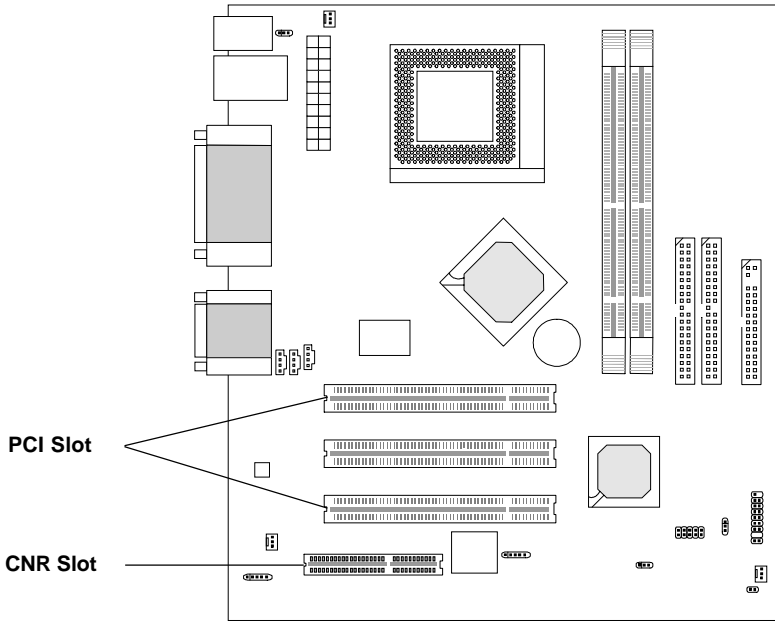

PCB 2.0

PCI Slots

Three PCI slots allow you to install expansion cards to meet your needs. When adding or removing expansion cards, make sure that you unplug the power supply first. Meanwhile, read the documentation for the expansion card to make any necessary hardware or software settings for the expansion card, such as jumpers, switches or BIOS configuration.

AMR (Audio Modem Riser) Slot (PCB 1.0 only)

The Audio/Modem Riser specification is an open industry-standard specification that defines a hardware scalable Original Equipment Manufacturer (OEM) mainboard riser board and interface, which supports both audio and modem.

Chapter 2

ISA Slot (PCB 1.0 only)

This slot allows you to install ISA expansion card.

CNR (Communication Network Riser) Slot (PCB 2.0 only)

The CNR specification is an open industry-standard specification that defines a hardware scalable Original Equipment Manufacturer (OEM) main-board riser board and interface, which supports audio and modem only.

PCI Interrupt Request Routing

The IRQ, abbreviation of interrupt request line and pronounced I-R-Q, are hardware lines over which devices can send interrupt signals to the microprocessor. The PCI/USB/AC97 IRQ pins are typically connected to the PCI bus INTA#-INTD# pins as follows:

	Order 1	Order 2	Order 3	Order 4
PCI Slot 1	INT A#	INT B#	INT C#	INT D#
PCI Slot 2	INT B#	INT C#	INT D#	INT A#
PCI Slot 3	INT C#	INT D#	INT A#	INT B#
USB-1	INT D#	INT A#	INT B#	INT C#
USB-2	INT D#	INT A#	INT B#	INT C#
AC97	INT C#	INT D#	INT A#	INT B#

AWARD® BIOS Setup**3**

The mainboard uses AWARD® BIOS ROM that provides a Setup utility for users to modify the basic system configuration. The information is stored in a battery-backed CMOS RAM so it retains the Setup information when the power is turned off.

This chapter provides you with the overview of the BIOS Setup program. It contains the following topics:

Entering Setup	3-2
Control Keys	3-2
Getting Help	3-3
The Main Menu	3-4
Standard CMOS Feature	3-6
Advanced BIOS Features	3-9
Advanced Chipset Features	3-13
Integrated Peripherals	3-18
Power Management Setup	3-24
PnP/PCI Configurations	3-31
PC Health Status	3-34
Frequency/Voltage Control	3-35
Load Fail-Safe/Optimized Defaults	3-37
Set Supervisor/User Password	3-39
Save & Exit Setup	3-41
Exit Without Saving	3-42

Chapter 3

Entering Setup

Power on the computer and the system will start POST (Power On Self Test) process. When the message below appears on the screen, press key to enter Setup.

Hit DEL if you want to run SETUP

If the message disappears before you respond and you still wish to enter Setup, restart the system by turning it OFF and On or pressing the RESET button. You may also restart the system by simultaneously pressing <Ctrl>, <Alt>, and <Delete> keys.

Control Keys

<↑>	Move to the previous item
<↓>	Move to the next item
<←>	Move to the item in the left hand
<→>	Move to the item in the right hand
<Enter>	Select the item
<Esc>	Jumps to the Exit menu or returns to the main menu from a submenu
<+/PU>	Increase the numeric value or make changes
<-/PD>	Decrease the numeric value or make changes
<F1>	General help, only for Status Page Setup Menu and Option Page Setup Menu
<F5>	Restore the previous CMOS value from CMOS, only for Option Page Setup Menu
<F6>	Load the default CMOS value from Fail-Safe default table, only for Option Page Setup Menu
<F7>	Load Optimized defaults
<F10>	Save all the CMOS changes and exit

Getting Help

After entering the Setup utility, the first screen you see is the Main Menu.

Main Menu

The main menu displays the setup categories the BIOS supplies. You can use the arrow keys (↑↓) to select the item. The on-line description for the selected setup category is displayed on the bottom of the screen.

Sub-Menu

If you find a right pointer symbol appears to the left of certain fields (as shown in the right view), that means a sub-menu containing additional options for the field can be launched from this field. To enter the sub-menu, highlight the field and press <Enter>. Then you can use control keys to move between and change the settings of the sub-menu. To return to the main menu, press <Esc>.

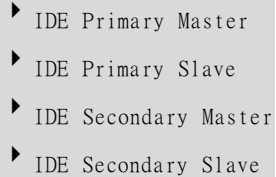
- 
- ▶ IDE Primary Master
 - ▶ IDE Primary Slave
 - ▶ IDE Secondary Master
 - ▶ IDE Secondary Slave

General Help <F1>

The BIOS setup program provides a General Help screen. You can call up this screen from any menu by simply pressing <F1>. The Help screen lists the appropriate keys to use and the possible selections for the highlighted item. Press <Esc> to exit the Help screen.

Chapter 3

The Main Menu

Once you enter AWARD® BIOS CMOS Setup Utility, the Main Menu will appear on the screen. The Main Menu displays eleven configurable functions and two exit choices. Use arrow keys to move among the items and press <Enter> to enter the sub-menu.

CMOS Setup Utility - Copyright(C) 1984-2000 Award Software

▸ Standard CMOS Features	▸ Frequency/Voltage Control
▸ Advanced BIOS Features	Load Fail-Safe Defaults
▸ Advanced Chipset Features	Load Optimized Defaults
▸ Integrated Peripherals	Set Supervisor Password
▸ Power Management Setup	Set User Password
▸ PnP/PCI Configurations	Save & Exit Setup
▸ PC Health Status	Exit Without Saving
ESC : Quit F9 : Menu in BIOS ↑↓←→ : Select Item	
F10 : Save & Exit Setup	
Time, Date, Hard Disk Type...	

Standard CMOS Features

Use this menu for basic system configurations, such as time, date etc.

Advanced BIOS Features

Use this menu to setup the items of Award® special enhanced features.

Advanced Chipset Features

Use this menu to change the values in the chipset registers and optimize your system's performance.

Integrated Peripherals

Use this menu to specify your settings for integrated peripherals.

Power Management Setup

Use this menu to specify your settings for power management.

PnP/PCI Configurations

This entry appears if your system supports PnP/PCI.

PC Health Status

This entry displays the current status of your PC.

Frequency/Voltage Control

Use this menu to specify your settings for frequency/voltage control.

Load Fail-Safe Defaults

Use this menu to load the BIOS default values for the minimal/stable performance of your PC.

Load Optimized Defaults

Use this menu to load the default factory settings for BIOS for optimal system performance.

Supervisor Password

Use this menu to set Supervisor Password.

User Password

Use this menu to set User Password.

Save & Exit Setup

Save changes to CMOS and exit setup.

Exit Without Saving

Abandon all changes and exit setup.

Chapter 3

Standard CMOS Features

The items inside Standard CMOS Features menu are divided into 13 categories. Each category includes none, one or more setup items. Use the arrow keys to highlight the item you want to modify and use the <PgUp> or <PgDn> keys to switch to the value you prefer.

CMOS Setup Utility - Copyright(C) 1984-2000 Award Software Standard CMOS Features

Date(mm:dd:yy):	Thu, Jan 4, 2001	Item Help	
Time (hh:mm:ss):	00:00:00		
▶ IDE Primary Master		Menu Level ▶ Change the day, month, year and century	
▶ IDE Primary Slave			
▶ IDE Secondary Master			
▶ IDE Secondary Slave			
Drive A	1.44 M, 3.5 in.		
Drive B	None		
Video	EGA/VGA		
Halt On	All, But Keyboard		
Base Memory	640K		
Extended Memory	65472K		
Total Memory	1024K		
↑ ↓ → ←: Move Enter: Select +/-/PU/PD: Value F10: Save ESC: Exit F1: General Help F5: Previous Values F6: Fail-Safe Defaults F7: Optimized Defaults			

Date

This allows you to set the system to the date that you want (usually the current date). The format is <day><month> <date> <year>.

day Day of the week, from Sun to Sat, determined by BIOS. Read-only.

month The month from Jan. through Dec.

date The date from 1 to 31 can be keyed by numeric

year function keys.
The year depends on the year of the BIOS.

Time

This allows you to set the system time that you want (usually the current time). The time format is <hour> <minute> <second>.

IDE Primary Master/Primary Slave/Secondary Master/Secondary Slave

Press PgUp/<+> or PgDn/<-> to select the hard disk drive type. The specification of hard disk drive will show up on the right hand according to your selection.

IDE Primary Master		ItemHelp
IDE HDD Auto-Detection	Press Enter	
IDE Primary Master	Auto	Menu Level ▶ ▶ To auto-detect the HDD's size, head...on this channel
AccessMode	Auto	
Capacity	15021MB	
Cylinder	291024	
Head	16	
Precomp	0	
Landing Zone	29103	
Sector	63	

- Access Mode The settings are Auto, CHS, LBA and Large.
- Capacity The formatted size of the storage device.
- Cylinder Number of cylinders.
- Head Number of heads.
- Precomp Write precompensation.
- Landing Zone Cylinder location of the landing zone.
- Sector Number of sectors.

Drive A/B

This item allows you to set the type of floppy drives installed. Available

Chapter 3

options are *None*, *360K, 5.25 in.*, *1.2M, 5.25 in.*, *720K, 3.5 in.*, *1.44M, 3.5 in.*, *2.88M, 3.5 in.*. The default value for Floppy Drive A is *1.44M, 3.5 in.*, and for Floppy Drive B is *None*.

Video

The item sets the type of video adapter used for the primary monitor of the system. Available options are *EGA/VGA*, *CGA 40*, *CGA 80* and *Mono*. Default value is *EGA/VGA*.

Halt On

The item determines whether the system will stop if an error is detected at boot. Available options are:

<i>All Errors</i>	The system stops when any error is detected.
<i>No Errors</i>	The system doesn't stop for any detected error.
<i>All, But Keyboard</i>	The system doesn't stop for a keyboard error.
<i>All, But Diskette</i>	The system doesn't stop for a disk error.
<i>All, But Disk/Key</i>	The system doesn't stop for either a disk or a keyboard error.

Advanced BIOS Features

CMOS Setup Utility - Copyright(C) 1984-2000 Award Software
Advanced BIOS Features

Anti-VirusProtection	Disabled	ItemHelp	
CPUInternalCache	Enabled		
ExternalCache	Enabled	Menu Level ▶ Allows you to choose the VIRUS warning feature for IDE Hard Disk boot sector protection. If this function is enabled and someone attempts to write data into this area, BIOS will show a warning message on screen and alarm beep.	
CPU L2 Cache ECC Checking	Enabled		
Processor Number Feature	Enabled		
Quick Power On Self Test	Disabled		
First Boot Device	Floppy		
Second Boot Device	HDD-0		
Third Boot Device	LS120		
Boot Other Device	Enabled		
Swap Floppy Drive	Disabled		
Boot Up Floppy Seek	Enabled		
Boot Up NumLock Status	On		
GateA20Option	Normal		
Typeomatic Rate Setting	Disabled		
x Typeomatic Rate (Chars/Sec)	6		
x Typeomatic Delay (Msec)	250		
SecurityOption	Setup		
OS Select for DRAM > 64MB	Non-OS2		
Video BIOS Shadow	Enabled		
C8000-CBFFF Shadow	Disabled		
CC000-CFFFF Shadow	Disabled		
D0000-D3FFF Shadow	Disabled		
D4000-D7FFF Shadow	Disabled		
D8000-DBFFF Shadow	Disabled		
DC000-DFFFF Shadow	Disabled		
↑ ↓ → ← : Move Enter: Select +/- /PU/PD: Value F10: Save ESC: Exit F1: General Help F5: Previous Values F6: Fail-Safe Defaults F7: Optimized Defaults			

Anti-Virus Protection

The item is to set the Virus Warning feature for IDE Hard Disk boot sector protection. If the function is enabled and any attempt to write data into this area is made, BIOS will display a warning message on screen and beep. Settings are *Disabled* and *Enabled*. Default value is *Disabled*.

Chapter 3

CPU Internal Cache

The item allows you to turn on or off CPU's internal (L1) cache. Settings are *Enabled* (default) and *Disabled*.

External Cache

This allows you to turn on or off L2 (Level 2) cache memory for CPU. Settings are *Enabled* (default) and *Disabled*.

CPU L2 Cache ECC Checking

This allows you to enable or disable the ECC (Error-Correcting Code) feature for error detection and correction when data passes through L2 cache memory. Settings are *Enabled* and *Disabled*. Default value is *Enabled*.

Processor Number Feature

This feature is for Pentium® !!! only. When set to *Enabled*, the system will check CPU Serial Number. Set to *Disabled* if you don't want the system to know the CPU Serial Number. Default value is *Enabled*.

Quick Power On Self Test

Setting the item to *Enabled* allows the system to shorten boot time since it will skip some check items. Settings are *Enabled* and *Disabled*. Default value is *Disabled*.

First/Second/Third Boot Device

The items allow you to set the sequence of boot devices where BIOS attempts to load the disk operating system. The settings are:

<i>HDD-0</i>	The system will boot from the first HDD.
<i>HDD-1</i>	The system will boot from the second HDD.
<i>HDD-2</i>	The system will boot from the third HDD.
<i>HDD-3</i>	The system will boot from the fourth HDD.
<i>Floppy</i>	The system will boot from floppy drive.
<i>ZIP100</i>	The system will boot from ATAPI ZIP drive.
<i>LS-120</i>	The system will boot from LS-120 drive.
<i>SCSI</i>	The system will boot from the SCSI.
<i>LAN</i>	The system will boot from the Network drive.
<i>CD-ROM</i>	The system will boot from the CD-ROM.

Disabled

Disable this sequence.

Boot Other Device

Setting the option to *Enabled* allows the system to try to boot from other device if the system fails to boot from the 1st/2nd/3rd boot device.

Swap Floppy Drive

Setting to *Enabled* will swap floppy drives A: and B:. Default is *Disabled*.

Boot Up Floppy Seek

Setting to *Enabled* will make BIOS seek floppy drive A: before booting the system. Setting options are *Disabled* and *Enabled*. Default is *Enabled*.

Boot Up NumLock Status

This item is to set the Num Lock status when the system is powered on. Setting to *On* will turn on the Num Lock key when the system is powered on. Setting to *Off* will allow end users to use the arrow keys on the numeric keypad. Settings are *On* and *Off*. Default is *On*.

Gate A20 Option

This item is to set the Gate A20 status. A20 refers to the first 64KB of extended memory. When the default value *Fast* is selected, the Gate A20 is controlled by Port92 or chipset specific method resulting in faster system performance. When *Normal* is selected, A20 is controlled by a keyboard controller or chipset hardware.

Typematic Rate Setting

This item is used to enable or disable the typematic rate setting including Typematic Rate & Typematic Delay.

Typematic Rate (Chars/Sec)

After Typematic Rate Setting is enabled, this item allows you to set the rate (characters/second) at which the keys are accelerated. Setting options are 6, 8, 10, 12, 15, 20, 24 and 30.

Chapter 3

Typematic Delay (Msec)

This item allows you to select the delay between when the key was first pressed and when the acceleration begins. Setting options are *250*, *500*, *750* and *1000*.

Security Option

This specifies the type of BIOS password protection that is implemented. Setting options are described below:

Option	Description
Setup (default)	The password prompt appears only when end users try to run Setup.
System	A password prompt appears every time when the computer is powered on or when end users try to run Setup.

OS Select for DRAM > 64MB

This allows you to run the OS/2[®] operating system with DRAM larger than 64MB. When you choose the default value *Non-OS2*, you cannot run the OS/2[®] operating system with DRAM larger than 64MB. But it is possible if you choose *OS2*. Default value is *Non-OS2*.

Video BIOS Shadow

This item sets if the Video BIOS will be copied to RAM and increase video speed accordingly. Settings are *Enabled* (default) and *Disabled*.

C8000-CBFFF/CC000-CFFFF/D0000-D3FFF/D4000-D7FFF/D8000-DBFFF/DC000-DFFFFShadow

These items specify whether the contents of the adapter ROM named in the items will be copied into RAM to improve the performance of ROM firmware for adapters. You need to know the address of each adapter ROM occupies to shadow (copy) it into the correct area of RAM. Settings are *Enabled* and *Disabled* (default).

Advanced Chipset Features

CMOS Setup Utility - Copyright(C) 1984-2000 Award Software
Advanced Chipset Features

DRAM Timing by SPD	Yes	ItemHelp
x SDRAM Cycle Length	3	
x DRAM Clock	Host CLK	Menu Level ▶
MemoryHole	Disabled	
P2C/C2PConcurrency	Enabled	
Fast R-W Turn Around	Enabled	
System BIOS Cacheable	Disabled	
VideoRAM Cacheable	Disabled	
Frame Buffer Size	8M	
AGP Aperture Size	64M	
OnChip USB	Enabled	
USB Keyboard Support	Disabled	
OnChipSound	Auto	
OnChipModem	Auto	
CPU to PCI Write Buffer	Enabled	
PCI Dynamic Bursting	Enabled	
PCI Master 0 WS Write	Enabled	
PCI Delay Transaction	Enabled	
PCI#2 Access #1 Retry	Enabled	
AGP Master 1 WS Write	Disabled	
AGP Master 1 WS Read	Disabled	
MemoryParity/ECCCheck	Disabled	
↑ ↓ → ← : Move Enter: Select +/- /PU/PD: Value F10: Save ESC: Exit F1: General Help F5: Previous Values F6: Fail-Safe Defaults F7: Optimized Defaults		

 **Note:** Change these settings only if you are familiar with the chipset.

DRAM Timing by SPD

Selects whether DRAM timing is configured by reading the contents of the SPD (Serial Presence Detect) device on the DRAM module. Setting to *Enabled* makes both DRAM Cycle Length and DRAM Clock automatically

Chapter 3

determined by BIOS according to the configurations on the SPD.

SDRAM Cycle Length

The option controls the CAS latency, which determines the timing delay before SDRAM starts a read command after receiving it. Settings are 2 and 3 (clock cycles). 2 increases system performance while 3 provides more stable system performance.

DRAM Clock

The chipset supports synchronous and asynchronous mode between host clock and DRAM clock frequency. The settings are:

- Host CLK* The DRAM clock will be equal to the Host Clock.
- HCLK-33M* The DRAM clock will be equal to the Host Clock minus 33MHz. For example, if the Host Clock is 133MHz, the DRAM clock will be 100MHz.
- HCLK+33M* The DRAM clock will be equal to the Host Clock plus 33MHz. For example, if the Host Clock is 100MHz, the DRAM clock will be 133MHz.

Memory Hole

In order to improve performance, certain space in memory can be reserved for ISA cards. This memory must be mapped into the memory space below 16MB. When this area is reserved, it cannot be cached. The settings are *Enabled* and *Disabled* (default).

P2C/C2P Concurrency

This field enables or disables the PCI to CPU and CPU to PCI concurrency feature, which allows synchronous data transmission from PCI to CPU and vice versa. Selecting the default *Enabled* will increase system performance.

Fast R-W Turn Around

This is used to control the fast read/write turn around feature for DRAM timing. Settings are *Enabled* and *Disabled* (default). *Enabled* improves system performance while *Disabled* provides stability.

System BIOS Cacheable

System BIOS ROM at F000h-F0000h is always copied to RAM for faster execution. Selecting *Enabled* allows the contents of F0000h RAM memory segment to be written to and read from cache memory, resulting in better system performance. However, if any program writes to this memory area, a system error may result. The settings are *Enabled* and *Disabled* (default).

Video RAM Cacheable

The field allows the caching of video memory, resulting in increased system performance. Settings are *Enabled* and *Disabled* (default).

Frame Buffer Size

Frame Buffer is the video memory that stores data for video display (frame). This field is used to determine the memory size for Frame Buffer. Larger frame buffer size increases video performance. Settings are *2M*, *4M* and *8M* (default).

AGP Aperture Size

Selects the size of the Accelerated Graphics Port (AGP) aperture. Aperture is a portion of the PCI memory address range dedicated for graphics memory address space. Host cycles that hit the aperture range are forwarded to the AGP without any translation. Options are *4M*, *8M*, *16M*, *32M*, *64M* and *128M*.

OnChip USB

This is used to enable or disable the USB ports. Settings are *Enabled* and *Disabled*. The default is *Enabled*.

USB Keyboard Support

Set to *Enabled* if your system installs and uses an USB keyboard. Default is *Disabled*.

OnChip Sound

Auto allows the mainboard to detect whether an audio device is used. If the device is detected, the onboard audio controller will be enabled; if not, the

Chapter 3

controller is disabled. Disable the controller if you want to use other controller cards to connect an audio device. Settings are *Auto* (default) and *Disabled*.

OnChipModem

Auto allows the mainboard to detect whether a modem is used. If a modem is detected, the onboard modem controller will be enabled; if not, the controller is disabled. Disable the controller if you want to use other controller cards to connect modems. Settings are *Auto* (default) and *Disabled*.

CPU to PCI Write Buffer

When *Enabled*, CPU can write up to four words of data into the PCI write buffer before the CPU must wait for PCI bus cycles to finish. When *Disabled*, the CPU must wait after each write cycle until the PCI bus signals that it is ready to receive more data.

PCI Dynamic Bursting

When *Enabled*, every write transaction goes to the write buffer. Then burstable transactions burst on the PCI bus and nonburstable transactions do not.

PCI Master 0 WS Write

When *Enabled*, writes to the PCI bus are executed with zero wait state. Default is *Enabled*.

PCIDelay Transaction

The chipset has an embedded 32-bit posted write buffer to support delay transactions cycles. Select *Enabled* to support compliance with PCI specification version 2.1. Default is *Enabled*.

PCI #2 Access #1 Retry

When *Disabled*, PCI#2 will not be disconnected until access finishes (default). When *Enabled*, PCI#2 will be disconnected if max retries are attempted without success. Default is *Enabled*.

AGP Master 1 WS Write

When *Enabled*, writes to the AGP bus are executed with one wait state inserted. Default is *Disabled*.

AGP Master 1 WS Read

When *Enabled*, one wait state is inserted in the AGP read cycle. Default is *Disabled*.

Memory Parity/ECC Check

User can set the field to *Enabled* for memory checking if the type of DRAM installed in your system is Parity or ECC (Error-Correcting Code) DRAM. Default is *Disabled*.

AGP Master 1 WS Write

When *Enabled*, writes to the AGP bus are executed with one wait state inserted. Default is *Disabled*.

Chapter 3

Integrated Peripherals

CMOS Setup Utility - Copyright(C) 1984-2000 Award Software
Integrated Peripherals

OnChip IDE Channel0	Enabled	Item Help	
OnChip IDE Channel1	Enabled		
IDE Prefetch Mode	Enabled	Menu Level ▶	
PrimaryMaster	PIO		Auto
PrimarySlave	PIO		Auto
SecondaryMaster	PIO		Auto
SecondarySlave	PIO		Auto
PrimaryMaster	UDMA		Auto
PrimarySlave	UDMA		Auto
SecondaryMaster	UDMA		Auto
SecondarySlave	UDMA		Auto
Init Display First			AGP
Onboard Lan Device			Enabled
IDE HDD Block Mode			Enabled
Onboard FDD Controller			Enabled
Onboard Serial Port 1			Auto
Onboard Serial Port 2			Auto
UART 2 Mode			Standard
x IR Function Duplex			Half
x TX, RX inverting enable			No, Yes
Onboard Parallel Port			378/IRQ7
Onboard Parallel Mode			Normal
x ECP Mode Use DMA		3	
x Parallel Port EPP Type		EPP1.9	
Onboard Legacy Audio		Enabled	
Sound Blaster		Disabled	
SB I/O Base Address		220H	
SB IRQ Select		IRQ5	
SB DMA Select		DMA1	
MPU-401		Disabled	
MPU-401 I/O Address		330-333H	
Game Port (200-207H)		Enabled	
↑ ↓ → ← : Move Enter: Select +/-/PU/PD: Value F10: Save ESC: Exit F1: General Help F5: Previous Values F6: Fail-Safe Defaults F7: Optimized Defaults			

OnChip IDE Channel0/1

The integrated peripheral controller contains an IDE interface with support for two IDE channels. Choose the default value *Enabled* to activate each channel separately.

IDE Prefetch Mode

The onboard IDE drive interfaces supports prefetching, for faster drive accesses. Set to *Disabled* if your primary and/or secondary add-in IDE interface does not support prefetching.

Primary/Secondary Master/Slave PIO

The four fields allow you to set a PIO (Programmed Input/Output) mode for each of the four IDE devices that the onboard IDE interface supports. Modes 0~4 provide increased performance. In Auto mode, BIOS automatically determines the best mode for each IDE device.

Primary/Secondary Master/Slave UDMA

Ultra DMA implementation is possible only if your IDE device supports it and your operating environment contains a DMA driver. If both your hard drive and software support Ultra DMA, select *Auto* (default) to enable BIOS support.

Init Display First

This item specifies which VGA card is your primary graphics adapter. Available options are *PCI Slot* and *AGP*. Default value is *AGP*.

Onboard Lan Device

This is used to enable or disable the onboard LAN controller. Settings are *Enabled* (default) and *Disabled*.

IDE HDD Block Mode

This allows your hard disk controller to use the fast block mode to transfer data to and from the hard disk drive. Block mode is also called block transfer, multiple commands or multiple sector read/write. *Enabled* enables IDE controller to use block mode; *Disabled* allows the controller to use standard mode. Default is *Enabled*.

Chapter 3

Onboard FDD Controller

This is to enable or disable the onboard Floppy controller. Set to *Enabled* if you have a floppy disk drive installed on the mainboard and want to use it.

Onboard Serial Port 1/2

These items specify the base I/O port address and IRQ for the onboard Serial Port 1 (COM 1)/Serial Port 2 (COM 2). Selecting to *Auto* allows BIOS to automatically determine the correct base I/O port address. Available options are *Auto*, *3F8/IRQ4*, *2F8/IRQ3*, *3E8/IRQ4*, *2E8/IRQ3* and *Disabled*. Default is *Auto*. If you have ISA add-on card, the suggested configuration is as the following:

If the ISA add-on card has				Onboard Serial port to be set at			
COM1 (I/O:3F8H)	COM2 (I/O:3F8H)	COM3 (I/O:3E8H)	COM4 (I/O:2E8H)	PORT1	IRQ ASSIGNED	PORT2	IRQ ASSIGNED
✓	✓	✓	✓	DISABLED	X	DISABLED	X
✓	✓	X	X	COM3	4	COM4	3
X	X	✓	✓	COM1	4	COM2	3
✓	X	X	✓	COM2	3	COM3	4
X	✓	✓	X	COM1	4	COM4	3
✓	✓	✓	X	COM4	3	DISABLED	X
✓	✓	X	✓	COM3	4	DISABLED	X
✓	X	✓	✓	COM2	3	DISABLED	X
X	✓	✓	✓	COM1	4	DISABLED	X
X	X	X	X	COM1	4	COM2	3
✓	X	X	X	COM2	3	COM3	4
X	✓	X	X	COM1	4	COM3	4
X	X	✓	X	COM1	4	COM2	3
X	X	X	✓	COM1	4	COM2	3

UART2Mode

The item allows you to specify the operation mode for serial port "COM 2". Settings are:

<i>Standard</i>	RS-232C Serial Port
<i>HPSIR</i>	IrDA-compliant Serial Infrared Port

ASKIR Amplitude Shift Keyed Infrared Port

IR Function Duplex

This field specifies a duplex value for the IR device connected to COM 2. Full-Duplex mode permits simultaneous two-direction transmission. Half-Duplex mode permits transmission in one direction only at a time. Settings are *Half* and *Full*. The default is *Half*.

TX, RX inverting enable

This item allows you to enable the TX, RX inverting which depends on different H/W requirement. This field is not recommended to change its default setting for avoiding any error in your system. Settings are “No, Yes” (default), “Yes, No”, “Yes, Yes” and “No, No.”

Onboard Parallel Port

This specifies the base I/O port address and IRQ of the onboard Parallel Port. Settings are *378/IRQ7*, *278/IRQ5*, *3BC/IRQ7* and *Disabled*. Default is *378/IRQ7*. If you have an ISA add-on card, the suggested configuration is as below:

If the ISA add-on card has			Onboard parallel port to be set as	
LPT1 I/O:378H	LPT2 I/O:278H	LPT3 I/O:3BCH	PORT ASSIGNED	IRQ ASSIGNED
✓	✓	✓	Disabled	X
✓	✓	X	LPT3	5
✓	X	✓	LPT2	5
X	✓	✓	LPT1	7
✓	X	X	LPT2	5
X	✓	X	LPT1	7
X	X	✓	LPT1	7
X	X	X	LPT1	7

Note: If the onboard parallel port interrupt and ISA add-on card interrupt are in conflict, the parallel port will not work properly. Please disable one of the devices.

Chapter 3

Onboard Parallel Mode

This item selects the operating mode for the parallel port: *Normal*, *EPP*, *ECP* or *ECP+EPP*. Default is *Normal*.

ECP Mode Use DMA

This item specifies an DMA channel 1 or 3 for the Parallel Port when it is set to *ECP* or *ECP+EPP* mode.

Parallel Port EPP Type

The item selects the EPP version used by the parallel port if the port is set to *EPP* or *ECP+EPP* mode. Settings are *EPP1.7* and *EPP1.9*.

Onboard Legacy Audio

The item enables or disables the onboard audio features of the mainbaord and the following audio options in the BIOS.

Sound Blaster

The item turns on/off the Sound Blaster feature of the board. If you want to play the Sound Blaster compatible games, you need to set the field to *Enabled*.

SB I/O Base Address

This item specifies the I/O Base Address for the Sound Blaster. Settings are 220H, 240H, 260H and 280H.

SB IRQ Select

This item specifies the IRQ for the Sound Blaster. Settings are IRQ 5, IRQ 7, IRQ 9 and IRQ 10.

SB DMA Select

This item specifies the DMA channel for the Sound Blaster. Settings are DMA 1, DMA 2, DMA 3 and DMA 0.

MPU-401

The field enables or disables the MPU-401 interface (the Yamaha Sound Blaster mode).

MPU-401 I/O Address

This item selects the base I/O port address for the MPU-401 interface. Settings are *330-333H*, *300-303* and *310-313*.

Game Port (200-207H)

The item enables or disables the Joystick/Game port.

Chapter 3

Power Management Setup

CMOS Setup Utility - Copyright(C) 1984-2000 Award Software
Power Management Setup

ACPIfunction	Enabled	Item Help
▶ PowerManagement	Press Enter	
ACPI Suspend Type	S1 (POS)	
PM Control by APM	Yes	Menu Level ▶
VideoOffOption	Suspend --> Off	
VideoOffMehtod	V/H SYNC + Blank	
MODEM Use IRQ	3	
Soft-Off by PWRBTN	Instant-Off	
State After Power Failure	Auto	
LED In Suspend	Blink	
▶ Wake Up Events	Press Enter	

↑ ↓ → ←: Move Enter: Select +/-/PU/PD: Value F10: Save ESC: Exit F1: General Help
F5: Previous Values F6: Fail-Safe Defaults F7: Optimized Defaults

ACPIFunction

This item is to activate the ACPI (Advanced Configuration and Power Management Interface) Function. If your operating system is ACPI-aware, such as Windows 98SE/2000/ME, select *Enabled*. Settings are *Enabled* and *Disabled*. Default is *Enabled*.

PowerManagement

Press <Enter> to enter the sub-menu for power management options.

Power Management

PowerManagement	User Define	Item Help
HDD Power Down	Disable	
DozeMode	Disable	Menu Level ▶ ▶
SuspendMode	Disable	

Power Management

This item is used to select the degree (or type) or power saving and is related to these modes: Doze Mode, Suspend Mode and HDD Power Down. There are three options for power management:

- Min Saving* Minimum Power Management. Doze Mode = 1 hour, Suspend Mode = 1 hour, and HDD Power Down = Disable.
- Max Saving* Maximum Power Management. Doze Mode = 10 sec, Suspend Mode = 10 sec, and HDD Power Down = Disable.
- User Define* Allows end users to configure each mode separately. Each of the ranges are from *1 min.* to *1 hour* except for HDD Power Down which ranges from *1 min.* to *15 min.*

Default value is *User Define*.

HDD Power Down

If HDD activity is not detected for the length of time specified in this field, the hard disk drive will be powered down while all other devices remain active. Settings are *Disable* and *1* through *15* Min.

Doze Mode

If system activity is not detected for the length of time specified in this field, the CPU clock will run at slower speed while other devices still run at full

Chapter 3

speed. Settings are *Disable, 1 Min, 2 Min, 4 Min, 6 Min, 8 Min, 10 Min, 20 Min, 30 Min, 40 Min* and *1 Hour*.

SuspendMode

If system activity is not detected for the length of time specified in this field, all devices except CPU will be shut off. Settings are *Disable, 1 Min, 2 Min, 4 Min, 6 Min, 8 Min, 10 Min, 20 Min, 30 Min, 40 Min* and *1 Hour*.

ACPI Suspend Type

This item specifies the power saving modes for ACPI function. Options are:

- | | |
|-----------------|---|
| <i>S1 (POS)</i> | The S1 sleep mode is a low power state. In this state, no system context is lost (CPU or chipset) and hardware maintains all system context. |
| <i>S3 (STR)</i> | The S3 sleep mode is a lower power state where the information of system configuration and open applications/files is saved to main memory that remains powered while most other hardware components turn off to save energy. The information stored in memory will be used to restore the system when an “wake up” event occurs. |

Default value is *S1 (POS)*.

PM Control by APM

Setting to *Yes* will activate an Advanced Power Management (APM) device to enhance Max Saving mode and stop CPU internal clock. Settings are *Yes* and *No*. Default is *Yes*.

Video Off Option

The settings are *Always On, Suspend* and *All Modes*. This option is for choosing the setting in which the monitor will turn off.

- | | |
|---------------------------|--|
| <i>Always On</i> | Always turn on. |
| <i>Suspend --> Off</i> | During Suspend mode, the monitor will be turned off. |

All Modes --> Off The monitor is turned off during Doze, Standby or Suspend mode.

Video Off Method

This determines the manner in which the monitor is blanked.

V/H SYNC+Blank This selection will cause the system to turn off the vertical and horizontal synchronization ports and write blanks to the video buffer.

Blank Screen This option only writes blanks to the video buffer.

DPMS Support Initial display power management signaling.

MODEMUseIRQ

Name the interrupt request (IRQ) line assigned to the modem (if any) on your system. Activity of the selected IRQ always awakens the system. Settings are 3, 4, 5, 7, 9, 10, 11 and NA.

Soft-Off by PWRBTN

This feature allows users to configure the power button as a normal power-on/-off button or a soft-off button. Settings are:

Instant-Off The power button functions as a normal power-on/-off button.

Delay 4 Sec. Pressing the power button for more than 4 seconds will place the system in a very low-power-usage state (Soft-Off state), with only enough circuitry receiving power to detect power button activity or Wake Up On LAN/Ring activity.

Default is *Instant-Off*.

State After Power Failure

This item specifies whether your system will reboot after a power failure or interrupts occurs. Available settings are:

Chapter 3

<i>Off</i>	Leaves the computer in the power off state.
<i>On</i>	Reboots the computer.
<i>Auto</i>	BIOS automatically determines the best mode.

LED In Suspend

This item sets how the system uses Power LED on the case to indicate the suspend state. Settings are:

<i>Blink</i>	The Power LED blinks to indicate the suspend state.
<i>Single</i>	The Power LED remains the same color.
<i>Dual</i>	The Power LED changes its color to indicate the suspend state.

Wake Up Events

Press <Enter> to enter the sub-menu and the following screen appears:

Wake Up Events		Item Help
VGA	OFF	
LPT & COM	LPT/COM	
HDD & FDD	ON	
PCI Master	OFF	Menu Level ▶ ▶
Wake Up On LAN	Disabled	
PowerOn by PCI Card	Disabled	
Modem Ring Resume	Disabled	
RTC Alarm Resume	Disabled	
x Date (of Month)	0	
x Resume Time (hh:mm:ss)	16 0 0	
▶ IRQs Activity Monitoring	Press Enter	

VGA, LPT & COM, HDD & FDD, PCI Master, Wake Up On LAN, PowerOn by PCI Card, Modem Ring Resume

These items specify whether the system will be awakened from power saving modes when activity or input signal of the specified hardware peripheral or component is detected.

Note: To use the function of Wake Up On LAN and Modem Ring Resume,

you need to install a LAN card/modem supporting power on function.

RTC Alarm Resume

This is to enable or disable the feature of booting up the system on a scheduled time/date. Settings are *Enabled* and *Disabled* (default)

Date (of Month)

Specifies the date for **RTC Alarm Resume**. Settings are *0~31*.

Resume Time (hh:mm:ss)

Specifies the time for **RTC Alarm Resume**. Format is <hour><minute><second>.

IRQs Activity Monitoring

Press <Enter> to enter the sub-menu and the following screen appears:

IRQs Activity Monitoring		
Primary INTR	On	ItemHelp
IRQ3 (COM 2)	Enabled	
IRQ4 (COM 1)	Enabled	
IRQ5 (LPT 2)	Enabled	
IRQ6 (Floppy Disk)	Enabled	
IRQ7 (LPT 1)	Enabled	
IRQ8 (RTC Alarm)	Disabled	
IRQ9 (IRQ2 Redir)	Disabled	
IRQ10 (Reserved)	Disabled	
IRQ11 (Reserved)	Disabled	
IRQ12 (PS/2 Mouse)	Enabled	
IRQ13 (Coprocesor)	Enabled	
IRQ14 (Hard Disk)	Enabled	
IRQ15 (Reserved)	Disabled	
		Menu Level ▶ ▶ ▶

Chapter 3

Primary INTR

When this is set to *On*, any event occurring will wake up the system which has been powered down.

IRQ3~IRQ15

Enables or disables the monitoring of the specified IRQ line. If set to *Enabled*, the activity of the specified IRQ line will prevent the system from entering power saving modes or awaken it from power saving modes.

Note: IRQ (Interrupt Request) lines are system resources allocated to I/O devices. When an I/O device needs to gain attention of the operating system, it signals this by causing an IRQ to occur. After receiving the signal, when the operating system is ready, the system will interrupt itself and perform the service required by the I/O device.

PnP/PCI Configurations

CMOS Setup Utility - Copyright(C) 1984-2000 Award Software
PnP/PCI Configurations

PNP OS Installed	No	Item Help
Reset Configuration Data	Disabled	
Resources Controlled By	Auto (ESCD)	Menu Level ▶ Select Yes if you are using a Plug and Play capable operation system Select No if you need the BIOS to configure non-boot devices
x IRQ Resources	Press Enter	
x DMA Resources	Press Enter	
PCI/VGA Palette Snoop	Disabled	
Assign IRQ For VGA	Enabled	
Assign IRQ For USB	Enabled	
↑↓ → ←: Move Enter: Select +/-/PU/PD: Value F10: Save ESC: Exit F1: General Help F5: Previous Values F6: Fail-Safe Defaults F7: Optimized Defaults		

PNP OS Installed

When set to *YES*, BIOS will only initialize the PnP cards used for booting (VGA, IDE, SCSI). The rest of the cards will be initialized by the PnP operating system like Windows® 95 or 98. When set to *NO*, BIOS will initialize all the PnP cards. So, select *Yes* if the operating system is Plug & Play aware.

Reset Configuration Data

The ESCD (Extended System Configuration Data) is a method that the BIOS uses to store resource information for both PNP and non PNP devices in a bit string format. When *Enabled*, the system will rebuild ESCD and you will see the message “ESCD Update Successfully” on boot up.

Chapter 3

Resources Controlled By

If select *Auto(ESCD)*, BIOS will automatically configure all the boot and PnP (Plug & Play) compatible devices and assigns system resources like IRQ to these devices. However, this feature means absolutely nothing unless you are using a Plug and Play operating system such as Windows®95/98. If you want to configure by yourself, select *Manual*. Default is *Auto(ESCD)*.

IRQ/DMA Resources

The items are adjustable only when **Resources Controlled By** is set to *Manual*. Press <Enter> and you will enter the sub-menu of the items. **IRQ Resources & DMA Resources** list IRQ 3/4/5/7/9/10/11/12/14/15 and DMA 0/1/3/5/6/7 for users to set each IRQ/DMA a type depending on the type of device using the IRQ/DMA. Settings are:

PCI/ISA PnP For Plug & Play compatible devices designed for PCI or ISA bus architecture.

Legacy ISA For devices compliant with the PC AT bus specification, requiring a specific interrupt.

PCI/VGA Palette Snoop

When set to *Enabled*, multiple VGA devices operating on different buses can handle data from the CPU on each set of palette registers on every video device. Bit 5 of the command register in the PCI device configuration space is the VGA Palette Snoop bit (0 is disabled). For example, if there are two VGA devices in the computer (one PCI and one ISA) and the:

VGA Palette Snoop Bit Setting	Action
<i>Disabled</i>	Data read or written by the CPU is only directed to the PCI VGA device's palette registers.
<i>Enabled</i>	Data read or written by the CPU is directed to both the PCI VGA device's palette registers and the ISA VGA device's palette registers, permitting the palette registers of both VGA devices to be identical.

The setting must be set to *Enabled* if any ISA adapter card installed in the system requires VGA palette snooping. The Setup and BIOS default values are *Disabled*.

Assign IRQ For VGA/USB

Set to *Enabled* allows BIOS to assign an IRQ to VGA card/USB device. Choose *Disabled* if you want to release the IRQ. Default is *Enabled*.

Chapter 3

PC Health Status

This section is to monitor the current hardware status including CPU temperature, CPU Fan speed, Vcore etc. This is available only if there is hardware monitoring onboard.

CMOS Setup Utility - Copyright(C) 1984-2000 Award Software
PC Health Status

Current CPU Temp. Current System Temp. Current CPUFAN1 Speed Current CPUFAN2 Speed Vcore 2.5V 3.3V 5V 12V	Item Help Menu Level ▶
↑ ↓ → ←: Move Enter: Select +/-/PU/PD: Value F10: Save ESC: Exit F1: General Help F5: Previous Values F6: Fail-Safe Defaults F7: Optimized Defaults	

Current CPU Temp., Current System Temp., Current CPUFAN1/2 Speed, Vcore, 2.5/3.3/5/12V

These items display the current status of all of the monitored hardware devices/components such as CPU voltages, temperatures and all fans's speed.

Frequency/Voltage Control

CMOS Setup Utility - Copyright(C) 1984-2000 Award Software
 Frequency/Voltage Control

Auto Detect DIMM/PCI Clk	Enabled	Item Help
Spread Spectrum	Disabled	
CPU Host/PCI Clock	Default	
		Menu Level ▶
↑ ↓ → ←: Move Enter: Select +/-/PU/PD: Value F10: Save ESC: Exit F1: General Help F5: Previous Values F6: Fail-Safe Defaults F7: Optimized Defaults		

Auto Detect DIMM/PCI Clk

Use this item to enable or disable the feature of auto detecting the clock frequency of the installed DRAM DIMMs and PCI cards. Settings are *Enabled* (default) and *Disabled*.

Spread Spectrum

This item is used to enable or disable the clock generator's Spread Spectrum feature. When overclocking the processor, always set it to *Disabled*. Settings are *Enabled* and *Disabled* (default).

Chapter 3

CPU Host/PCIClock

This item specifies the clock frequency of CPU host bus (FSB) and PCI bus and provides a method for end users to overclock the processor accordingly. If the item shows *Default*, the clock frequency will use the default value for both the CPU host bus and PCI bus.

Load Fail-Safe/Optimized Defaults

The two options on the main menu allow users to restore all of the BIOS settings to the default Fail-Safe or Optimized values. The Optimized Defaults are the default values set by the mainboard manufacturer specifically for the optimal performance of the mainboard. The Fail-Safe Defaults are the default values set by the BIOS vendor for the stable system performance.

When you select Load Fail-Safe Defaults, a message as below appears:

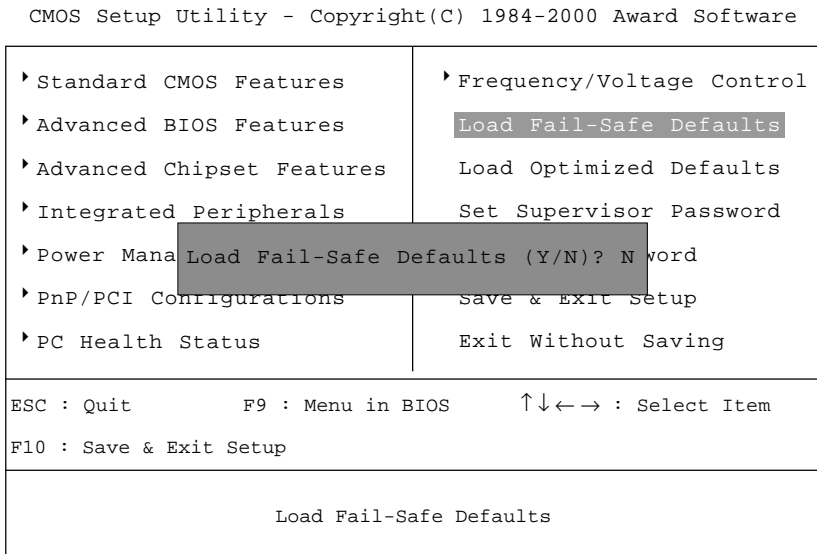

Pressing Y loads the BIOS default values for the most stable, minimal system performance.

Chapter 3

When you select Load Optimized Defaults, a message as below appears:

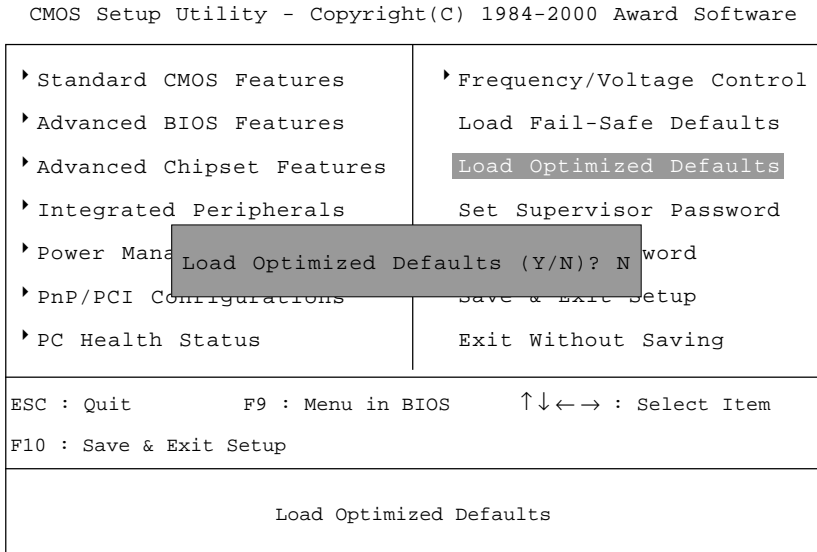

Pressing *Y* loads the default factory settings for optimal system performance.

Set Supervisor/User Password

When you select this function, a message as below will appear on the screen:

CMOS Setup Utility - Copyright(C) 1984-2000 Award Software

<ul style="list-style-type: none"> ▸ Standard CMOS Features ▸ Advanced BIOS Features ▸ Advanced Chipset Features ▸ Integrated Peripherals ▸ Power Management Setup ▸ PnP/PCI Configurations ▸ PC Health Status 	<ul style="list-style-type: none"> Load Fail-Safe Defaults Load Optimized Defaults Set Supervisor Password Set User Password Exit Without Saving
<p>Enter Password:</p>	
<p>ESC : Quit F9 : Menu in BIOS ↑↓←→ : Select Item</p> <p>F10 : Save & Exit Setup</p>	
<p>Change/Set/Disable Password</p>	

Type the password, up to eight characters in length, and press <Enter>. The password typed now will clear any previously set password from CMOS memory. You will be prompted to confirm the password. Re-type the password and press <Enter>. You may also press <Esc> to abort the selection and not enter a password.

To clear a set password, just press <Enter> when you are prompted to enter the password. A message will show up confirming the password will be disabled. Once the password is disabled, the system will boot and you can enter Setup without entering any password.

When a password has been set, you will be prompted to enter it every time you

Chapter 3

try to enter Setup. This prevents an unauthorized person from changing any part of your system configuration.

Additionally, when a password is enabled, you can also have BIOS to request a password each time the system is booted. This would prevent unauthorized use of your computer. The setting to determine when the password prompt is required is the Security Option of the Advanced BIOS Features menu. If the Security Option is set to *System*, the password is required both at boot and at entry to Setup. If set to *Setup*, password prompt only occurs when trying to enter Setup.

About Supervisor Password & User Password:

Supervisor password : Can enter and change the settings of the setup menus.

User password: Can only enter but do not have the right to change the settings of the setup menus

Save & Exit Setup

When you want to quit the Setup menu, you can select this option to save the changes and quit. A message as below will appear on the screen:

CMOS Setup Utility - Copyright(C) 1984-2000 Award Software

<ul style="list-style-type: none"> ▶ Standard CMOS Features ▶ Advanced BIOS Features ▶ Advanced Chipset Features ▶ Integrated Peripherals ▶ Power Management Setup ▶ PnP/PCI Configurations ▶ PC Health Status 	<ul style="list-style-type: none"> ▶ Frequency/Voltage Control Load Fail-Safe Defaults Load Optimized Defaults Load Setup Defaults Load User Defaults Set Supervisor Password Set User Password Save & Exit Setup Exit Without Saving
<p>SAVE to CMOS and Exit(Y/N)? Y</p>	
<p>ESC : Quit F9 : Menu in BIOS ↑↓←→ : Select Item</p> <p>F10 : Save & Exit Setup</p>	
<p>Save Data to CMOS</p>	

Typing *Y* will allow you to quit the Setup Utility and save the user setup changes to RTC CMOS.

Typing *N* will return to the Setup Utility.

Chapter 3

Exit Without Saving

When you want to quit the Setup menu, you can select this option to abandon the changes. A message as below will appear on the screen:

CMOS Setup Utility - Copyright(C) 1984-2000 Award Software

▸ Standard CMOS Features	▸ Frequency/Voltage Control
▸ Advanced BIOS Features	Load Fail-Safe Defaults
▸ Advanced Chipset Features	Load Optimized Defaults
▸ Integrated Peripherals	Set Supervisor Password
▸ Power Mana	Quit Without Saving(Y/N)? Y
▸ PnP/PCI Configurations	Save & Exit Setup
▸ PC Health Status	Exit Without Saving

ESC : Quit F9 : Menu in BIOS ↑↓←→ : Select Item
F10 : Save & Exit Setup

Abandon all Datas

Typing *Y* will allow you to quit the Setup Utility without saving any changes to RTCCMOS.

Typing *N* will return to the Setup Utility.

Drivers

4

The chapter describes the features and basic system requirements for the VIA® chipset and Realtek® 8139C LAN controller, and how to install the drivers into your system.

This chapter contains the following topics:

System Requirements	4-2
VIA® Chipset	4-3
Realtek® 8139C Fast Ethernet Controller	4-8

Chapter 4

System Requirements

This section describes the basic system requirements for the VIA[®] and LAN drivers installation and usage.

CPU

Intel[®] Celeron[™]/Pentium !!! processor or higher

Chipset

VIA[®] VT8601A & VT686A/686B chipset

Monitor

VGA Support, minimum 640x480 resolution

Operating system

DOS 5.0 or higher, Windows[®] 95/98, Windows[®] NT3.51/4.0, OS/2[®], Windows[®] 2000 or Windows[®] ME

CD-ROM

2X speed or above

VIA® Chipset

The MS-6368 is paired with the VIA® VT82C686A/686B south bridge. Highly advanced, the south bridge combines an integrated 2D/3D engine with DVD hardware acceleration, AC-97 audio support for SoundBlaster Pro and FM synthesis legacy audio.

Features

- AC'97 audio support for SoundBlaster Pro
- FM synthesis legacy audio
- 2D/3D Graphics Accelerator
- Support AGP 2X/4X Bus

VIA Chipset Driver Installation

Insert the provided CD disk into the CD-ROM drive. The CD will auto-run and display “**VIA Chipset Drivers**,” “VIA PLE133 VGA Driver,” “VIA AC97 PCI Sound Drivers” and “Realtek 8139 Network Drivers” on the screen. Click on the appropriate button for installation.

Installation for Windows® 98SE

1. Insert the CD disk into the CD-ROM drive
2. The CD will auto-run and the setup screen will appear.
3. Click on the “VIA Chipset Drivers” and the screen will show “VIA Service Pack 4.XX.”
4. Click “Next” and the screen will show four drivers “VIA Atapi Vendor Support Driver,” “AGP VxD Driver,” “VIA Chipset Function’s Registry” and “IRQ Routing Miniport Driver”. Select all four drivers and click on “Next”.
5. The setup program will request you to choose “Install VIA Atapi Vendor Support Driver”. Please select “Install” and click “Next” to continue.
6. Click to enable DMA Mode, Please select “Install” and click “Next” to continue.
7. The setup program will request you to choose “Install VIA AGP VxD in turbo mode”, “Install VIA AGP VxD in normal mode” or “Uninstall VIA AGP VxD”. Please select “Install VIA AGP VxD in turbo mode”

Chapter 4

- and click on “Next”.
8. The setup program will let you choose between “Install VIA Chipset Functions Registry” or “Uninstall VIA Chipset Functions Registry”. Please select “Install VIA Chipset Functions Registry” and then click “Next”.
 9. The setup program will let you choose between “Install VIA IRQ Routing Miniport Driver” or “Uninstall VIA IRQ Routing Miniport Driver”. Please select “Install VIA IRQ Routing Miniport Driver”
 10. The setup program will request you to choose whether to restart the computer or not. Please select “Yes, I want to restart my computer now” and click Finish. The computer will restart and finish the VIA Chipset Drivers installation.

Installation for Windows® 2000/ME

1. Insert the CD disk into the CD-ROM drive
2. The CD will auto-run and the setup screen will appear.
3. Click on the “VIA Chipset Drivers” and the screen will show “VIA Service Pack 4.XX.”
4. Click “Next” and the screen will show VIA Service Pack (VIA 4 in 1) Readme.TXT.
5. Click “Yes” and the screen will show two drives “AGP VxD Driver” and “VIA INF Driver 1.0x.” Select all and click “Next” to proceed to next step.
6. The setup program will request you to choose “Install AGP 4X/133 Driver”. Select “Install” and then click on “Next”.
7. The setup program will request you to choose whether to restart the computer or not. Please select “Yes, I want to restart my computer now” and click Finish. The computer will restart and finish the VIA Chipset Drivers installation.

Installation for Windows® NT4.0

Note: Install Windows® NT 4.0 Service Pack 3 or above before installing the VIA drivers in Windows® NT.

1. Insert the CD disk into the CD-ROM drive
2. The CD will auto-run and the setup screen will appear.
3. Click on the “VIA Chipset Drivers” and the screen will show “VIA Service Pack 4.XX.”

4. Click “Next” to proceed and the screen will show “Install”, “Uninstall” or “Enable/Disable Ultra DMA for IDE Driver”.
Select “Install” and then click on “Next”.
5. Please click on “Yes, I want to restart my computer” to complete setup.

VIA PLE133 VGA Driver Installation

Insert the provided CD disk into the CD-ROM drive. The CD will auto-run and display “VIA Chipset Drivers,” “**VIA PLE133 VGA Driver,**” “VIA AC97 PCI Sound Drivers” and “Realtek 8139 Network Drivers” on the screen. Click on the appropriate button for installation.

Note: Always install the VIA Chipset drivers before VIA PLE133 VGA driver.

Installation for Windows® 98SE/2000/ME/NT4.0

1. Insert the CD disk into the CD-ROM drive
2. The CD will auto-run and the setup screen will appear.
3. Click on the “VIA PLE133 VGA Driver” and the screen will show an installation menu.
4. Click on “Display Drivers.”
5. Click on “OK” and the VGA drivers will be copied into the HDD.
6. A message appears prompting you to restart the Windows® system. Select “Yes” to restart the system.
7. After restart, Windows will show a new display setting.

Note: For Windows NT4.0, you must install Windows® NT 4.0 Service Pack 3 or above before installing the VIA drivers.

VIA AC97 PCI Sound Driver Installation

Insert the provided CD disk into the CD-ROM drive. The CD will auto-run and display “VIA Chipset Drivers,” “VIA PLE133 VGA Driver,” “**VIA AC97 PCI Sound Drivers**” and “Realtek 8139 Network Drivers” on the screen. Click on the appropriate button for installation.

Note: Always install the VIA Chipset drivers before VIA AC97 PCI Sound

Chapter 4

driver.

Installation for Windows® 98SE

1. Insert the CD disk into the CD-ROM drive
2. The CD will auto-run and the setup screen will appear.
3. Click on the “VIA AC97 PCI Sound Drivers” and the screen will show “VIA AC97 PCI Sound Drivers.”
4. Click “Next” to proceed and the screen will show “Install”, or “Uninstall”. Select “Install” and then click on “Next”.
5. Click “Finish” to complete the AC97 Audio Driver Installation.

Installation for Windows® 2000/ME

1. Insert the CD disk into the CD-ROM drive
2. The CD will auto-run and the setup screen will appear.
3. Click on the “VIA AC97 PCI Sound Drivers” and the screen will show “VIA AC97 PCI Sound Drivers.”
4. Click “Next” to proceed and the screen will show “Install”, or “Uninstall”. Select “Install” and then click on “Next”.
5. A window “Digital Signature Not Found” will appear and will request “Do you want to continue the installation of the VIA AC’97 Audio Controller (WDM) Driver?” Please click “Yes” to proceed.
6. Click “Finish” to complete setup.

Installation for Windows® NT4.0

1. Insert the CD disk into the CD-ROM drive
2. The CD will auto-run and the setup screen will appear.
3. Click on the “VIA AC97 PCI Sound Drivers” and the screen will show “VIA AC97 PCI Sound Drivers.”
4. Click “Next” to proceed and the screen will show “Install”, or “Uninstall”. Select “Install” and then click on “Next”.
5. The setup program will show the following on the screen:

Please choose “Add” from the next window
and add the following device:
VIA AC97 PCI Audio Device
VIA MIDI External Port

Then click “OK”.

6. Follow the steps shown in **Step 5** to finish the VIA AC97 PCI Audio Drivers Installation.
7. A window will appear asking “Do you want to install the joystick driver for the Microsoft Sidewinder 3D Pro Joystick?” Please click “No” to continue.
8. Please click “Finish” to complete setup.

Realtek® 8139C Fast Ethernet Controller

When your mainboard comes with the Realtek® 8139C LAN controller, you must install the Realtek® LAN driver to support the LAN function. The Realtek® 8139C is a sophisticated 32-bit PCI component, with enhanced scatter-gather bus mastering capabilities. Its true 32-bit architecture enables it to perform high speed data transfers on the PCI bus using four DMA channels.

Features

- IEEE 802.3/802.3u 10BASE-T and 100BASE-TX compatible
- Glueless 32-bit PCI bus master interface
- Backward software compatible to the 82557
- Internal transmit and receive FIFOs (3 kbytes each)
- Back-to-back transmit at 100 Mbps within minimum IFS
- EEPROM support for configuration and customized feature selection
- Advanced configuration and Power Interface Specification, Revision 1.0, and PCI Power Management Specification, Revision 1.0 compliant
- Remote Wake Up (Magic Packet*) support in APM and ACPI modes
- ACPI “interesting” packet wake support in D0 to D3 low power states
- IEEE 802.3u Auto-Negotiation support for 10BASE-T and 100BASE-TX
- Full or half duplex capable at 10 or 100 Mbps
- IEEE 802.3x flow control support

Driver Installation

Installation for Windows® 98

In some operating systems like Windows® 98, the provided CD will auto-run when you insert the CD disk into the CD-ROM drive. To install the LAN driver, just click on the “**Realtek 8139 Network Drivers**” button on the screen.

Installation for Other O/S

To find out the installation procedures for other operating systems such as Windows® 2000 & Linux, insert the provided CD disk into the CD-ROM drive. Run or type the path to:

CD-ROM drive: *\Network\Realtek\8139\Help8139.exe*

Then press spacebar to continue and installation for different operating systems on the LAN driver is listed on the screen. Select the operating system you need by using arrow keys and follow the installation procedures provided.