



Apollo/Shadowhawk

U S E R M A N U A L





System Manual

Copyright

PREMIO is a registered trademark of Premio Computer, Inc. All other brands and product names are trademarks or registered trademarks of their respective companies.

© 1997 by Premio Computer, Inc. All rights reserved.

Printed in Taiwan.

Version 2.0, September, 1997.

Disclaimers

PREMIO makes no representation or warranties, either expressed or implied, with respect to the contents of this publication and specifically disclaims the implied warranties of merchantability or fitness for a particular purpose. PREMIO shall not be liable for technical or editorial errors or omissions in this publication, or for incidental or consequential damages resulting from the furnishing, performance, or use of this publication. We reserve the right to revise this publication and to make changes from time to time in its contents without notification.

Contents

GETTING STARTED	1
Setting Up.....	2
Switches and Indicators.....	3
UPGRADING	5
Opening the System Unit.....	6
Installing an Expansion Card	7
Installing Memory	8
Installing a SIMM	8
Removing a SIMM.....	9
Installing a DIMM	9
Removing a DIMM.....	10
Installing a Hard Drive.....	11
GETTING HELP.....	12
Troubleshooting	12
Monitor Does Not Work	12
Keyboard Does Not Work.....	13
Mouse Does Not Work.....	13
System Unit Problems.....	14
Hard Disk Problems	14

Warranty Service.....	15
Technical Support.....	15
PREMIO on the Internet.....	15
APPENDIX	16
Limited 3-Year Warranty.....	16
FCC Standards	18
Important Safety Instructions.....	19

Getting Started

Your PREMIO[®] system consists of three components:

- a mid-tower or desktop system unit
- a keyboard
- a mouse

Add your choice of monitor, and your system is ready to use.

Mid-tower system

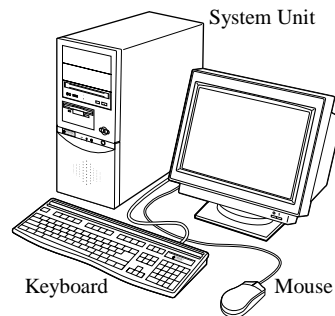

Desktop system

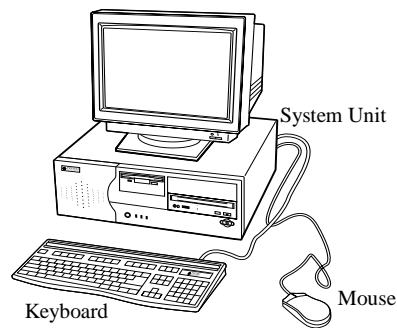

Setting Up

To set up your PREMIO system, simply connect your monitor, the mouse, the keyboard, and any additional components you want to use to the system unit.

Follow these easy steps:

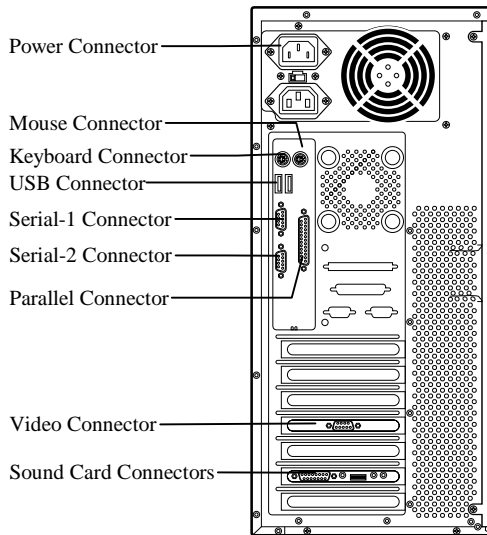

- 1 Attach your monitor's video cable to the video connector.
- 2 Attach the mouse cable to the mouse connector.
- 3 Attach the keyboard cable to the keyboard connector.
- 4 Attach the cables for any additional components, such as a printer, scanner, or modem, to the parallel, serial, or universal serial bus (USB) connector, as directed in the component's manual.
- 5 If your system is equipped for multimedia, attach your speakers and microphone to the sound card connectors.

6 Plug your monitor's power cord into a power outlet.

7 Attach the female end of the system power cord to the system unit's power connector, and then plug the other end of the cord into a power outlet.

Your PREMIO system is now ready to use. To start the system, turn on your monitor's power switch and then press the system power switch as shown on the next page.

Switches and Indicators

The system unit's front panel provides access to the CD-ROM and floppy drives, and to the system's switches and indicator lights.

The illustration below shows a mid-tower system. If you have a desktop system, turn to the illustration on the next page.

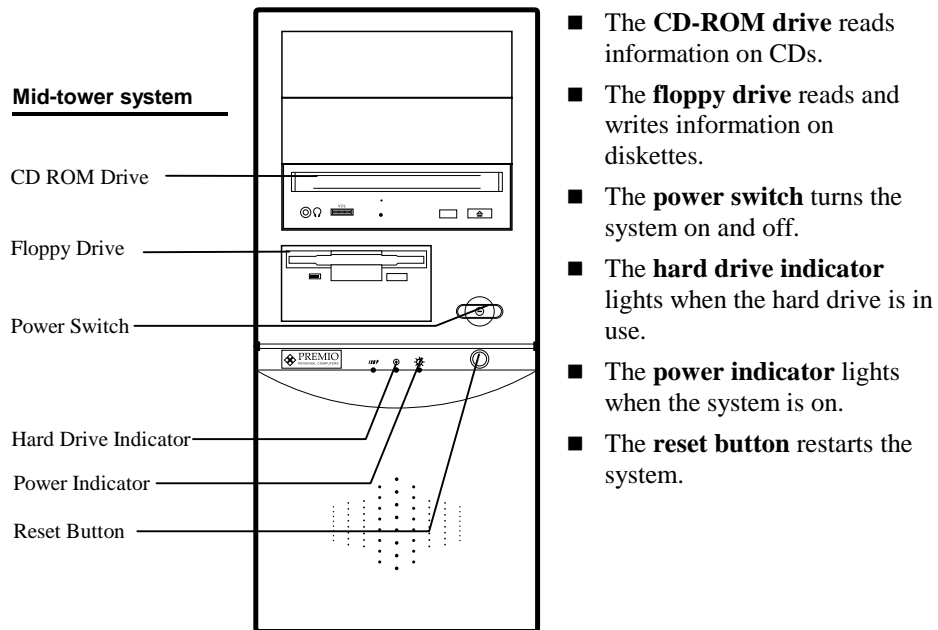

Desktop system

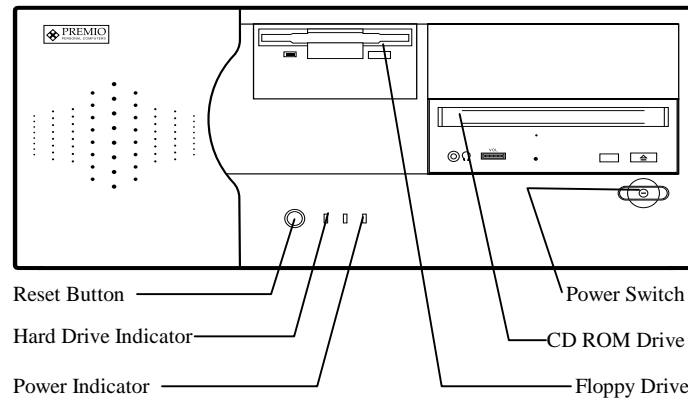

- The **reset button** restarts the system.
- The **hard drive indicator** lights when the hard drive is in use.
- The **power indicator** lights when the system is on.
- The **power switch** turns the system on and off.
- The **CD-ROM drive** reads information on CDs.
- The **floppy drive** reads and writes information on diskettes.

Upgrading

You can upgrade your PREMIO system with:

- Expansion cards
- More memory
- An additional hard drive

To install an upgrade, you must open the system unit. Before proceeding, read the important cautionary note below. Then follow the steps on the next page.

Caution! *Static discharge can cause permanent damage to internal electronic components of your computer. Always use the following precautions when working inside the system unit:*

- *Wear a grounding wrist strap (available at most electronics stores) when handling electronic components.*
- *Do not remove a component from its antistatic packaging until you are ready to install it.*
- *Keep one hand in contact with the metal system case.*

Opening the System Unit

Note *Opening the system unit could affect your warranty. Check with the dealer where you purchased your system before opening the system unit.*

To open the system unit, follow these steps

Mid-tower system

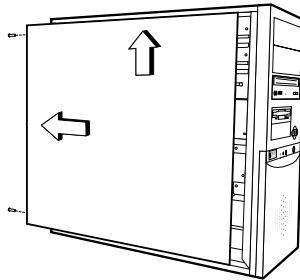

- 1** Turn off the system and unplug the power cord.
- 2** Remove the screws securing the side panel (mid-tower) or case (desktop) at the rear of the system unit.

Desktop system

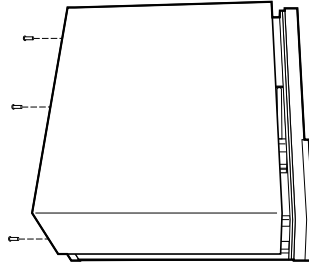

- 3** Slide the side panel or case up and to the rear, and remove it.

Installing an Expansion Card

To install an expansion card, open the system unit as described

on the previous page. Then follow these steps:

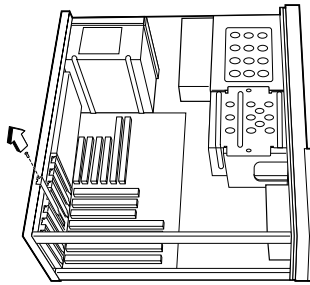

use. Save the screw to secure the expansion card.

- 1** Remove the screw securing the slot bracket cover for the expansion slot you want to

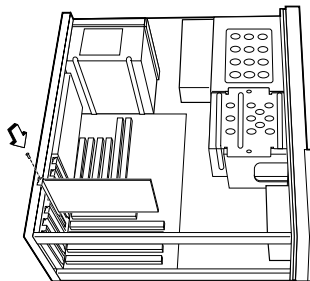

- 2** Insert the expansion card firmly into the slot, making sure it is seated completely.
- 3** Secure the card with the saved screw.

Installing Memory

Note For details on memory configuration, including the placement and type of memory to use in your system, refer to the motherboard user's manual that came with your system.

Follow these general guidelines when adding memory:

- Use only the same type of memory throughout. For example, do not mix EDO and fast page memory.
- SIMMs must be installed in pairs, and both SIMMs in the pair must be the same size and speed. For example, do not install one 16-MB and one 8-MB SIMM.

Installing a SIMM

To install a SIMM, follow these steps:

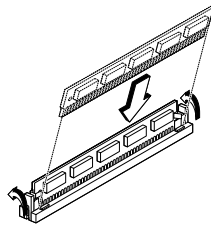

- 1** Insert the SIMM into the socket at a 45° angle. (SIMMs can be installed only one way.)
- 2** Gently press the SIMM up into a vertical position until it snaps into place. The SIMM's clips will hold it firmly at a 90° angle when it is properly installed.

Removing a SIMM

To remove a SIMM, follow these steps:

- 1 Press the holding clips on both sides of the SIMM outward to release it.

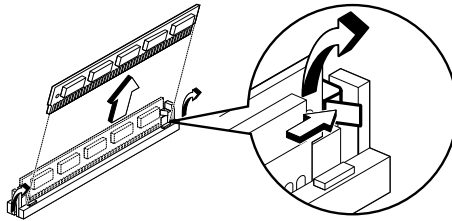

- 2 Tilt the SIMM to a 45° angle.
- 3 Pull the SIMM up and out of the socket.

Installing a DIMM

To install a DIMM, follow these steps:

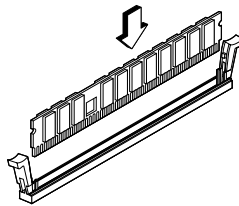

- 1 Insert the DIMM vertically into the socket. (DIMMs can fit into the slot only one way.)
- 2 Push down on the DIMM to seat it, and then raise the plastic clips at either side to lock it in place.

Removing a DIMM

To remove a DIMM, follow these steps:

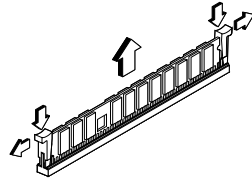

1 Push down and out on the plastic clips at either end to release them.

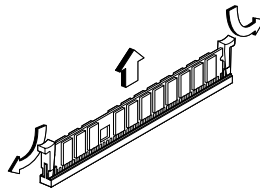

2 Pull the DIMM up and out of the socket.

Installing a Hard Drive

To install a hard drive in your system, follow these steps:

Mid-tower system

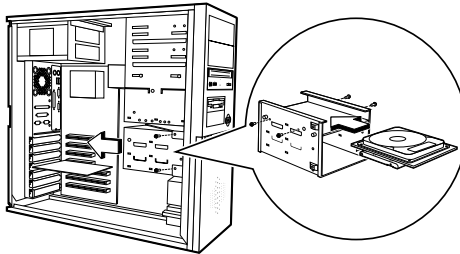

Desktop system

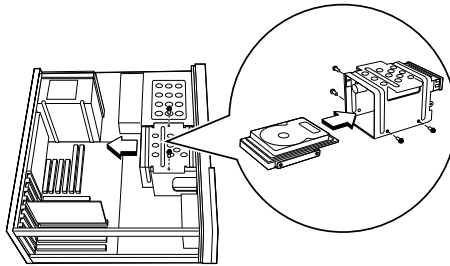

- 1 Disconnect the hard drive cable and power connector.
- 2 Remove the two screws securing the drive bay.
- 3 Slide the bay toward the rear of the system unit to remove it.
- 4 Insert the new drive into an open position in the bay and secure it with four screws.
- 5 Slide the bay back into the system unit and secure it with two screws.
- 6 Connect the cables.

Getting Help

Troubleshooting

Your PREMIO system is designed to provide years of trouble-free performance. If you have a problem with your system, first check the information in this section for a quick solution.

Monitor Does Not Work

If your monitor appears not to be working properly:

- Check that the monitor's power cable is securely attached to the monitor and to an outlet that is receiving power.
- Check that the monitor's video cable is securely attached to the monitor and to the system unit's video card connector.
- Check that the monitor's power switch is on.
- Adjust the monitor's brightness and contrast controls.
- If possible, substitute another monitor that is in good working order. If the substitute works, your monitor may need repair or replacement.

Keyboard Does Not Work

If the NumLock indicator in the upper right corner of the keyboard does not light when the system powers up, or the keyboard does not work:

- Check that the keyboard cable is securely attached to the system unit's keyboard connector.
- If possible, substitute another keyboard that is in good working order. If the substitute works, your keyboard may need replacement.

Mouse Does Not Work

If your mouse pointer does not move or moves erratically when you move the mouse:

- Check that the mouse cable is securely attached to the mouse connector on the system unit.
- Disassemble the mouse and clean the roller ball.

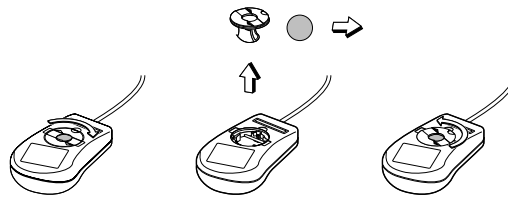

System Unit Problems

The fan inside the system unit should make a low, steady sound when operating properly. If the fan is totally silent:

- Check that the system power cord is securely attached to the back of the system unit and to a power outlet. Verify that the outlet has power.
- If possible, substitute another power cord that is in good working order. If the substitute works, replace your power cord.

If the fan makes excessive noise:

- Turn off the system, open the system unit case, and inspect the fan for any obstructions.
- Turn on the system and listen closely to the fan. If the noise comes from inside the fan housing, your power supply may need replacement.

Hard Disk Problems

Your hard disk should make a slight whirring sound when operating properly. If the disk is totally silent:

- Turn off the system, open the system unit case, and check that the power cable between the power supply and the hard disk is securely attached at both ends. If it is, your hard disk may be defective.

If the hard disk makes excessive noise:

- Turn off the system, open the system unit case, and remove the hard disk power cable connector from the hard disk. Then turn the system back on. If the noise disappears, your hard disk may be defective.
- If you have more than one hard disk, repeat the same procedure for each disk.

Warranty Service

If you have a problem with your PREMIO system that requires service during the warranty period, contact the dealer where you purchased your system. Your dealer will try to resolve the problem for you. If your dealer cannot resolve the problem, you can contact PREMIO directly at the address below.

Note *To obtain warranty service, you must provide proof of purchase, including the purchase date.*

Technical Support

You can contact PREMIO technical support at the following address:

Premio Computer, Inc.
918 Radecki Court
City of Industry, CA 91748
Telephone: 800-568-6388
Fax: 626-839-3191
Email: support@premiopc.com

PREMIO on the Internet

PREMIO maintains a web page on the Internet with the latest information on PREMIO products, updated drivers, answers to common problems, a Windows 95 troubleshooting guide, and more. Visit our web page at:

<http://www.premiopc.com>

Appendix

Limited 3-Year Warranty

Premio Computer, Inc. warrants its line of PREMIO® computer systems (hereinafter "Product") to be free from defects in material and workmanship for a period of three (3) years from the date of original purchase from Premio Computer, Inc. or a Premio Computer, Inc. authorized reseller. This warranty does not cover monitor and LCD panels, nor third-party hardware and software which has a separate manufacturer's warranty. Warranty for such third-party hardware and software, if any, is subject to the third-party's warranty policy.

PREMIO branded monitors are warranted as follows:

Three (3) year parts and labor except for CRT

One (1) year parts and labor for CRT

PREMIO branded LCD panels are warranted as follows:

One (1) year parts and labor

SERVICE UNDER WARRANTY

If this Product fails to be in good working order during this 3-year warranty period (or specific period of time as noted above), Premio Computer, Inc. will, at its option, repair or replace the Product. Repair parts and/or replacement Products may be either new or reconditioned at Premio Computer Inc.'s discretion. The limited warranty does not include service to repair damage from improper installation, abuse or modifications to the Product not approved in writing by Premio Computer, Inc. Any service repair outside the scope of this limited warranty shall be at Premio Computer, Inc.'s or its Authorized Service Provider's rates and terms in effect.

This warranty is valid only within the United States and applies only to Products which are new and in cartons which are unopened on the date of purchase.

EXCLUSIONS FROM PREMIO, INC. LIMITED WARRANTY PROGRAM

ALL OTHER EXPRESSED AND IMPLIED WARRANTIES FOR THIS PRODUCT, INCLUDING THE WARRANTIES OF MERCHANTABILITY AND FITNESS FOR A PARTICULAR PURPOSE, ARE HEREBY DISCLAIMED. IF THIS PRODUCT IS NOT IN GOOD WORKING ORDER AS WARRANTED ABOVE, PREMIO COMPUTER, INC.'S SOLE AND EXCLUSIVE REMEDY SHALL BE REPAIR OR REPLACEMENT AS STATED ABOVE. IN NO EVENT WILL PREMIO COMPUTER, INC. BE LIABLE TO THE CUSTOMER OR ANY THIRD PARTY FOR ANY DAMAGES IN EXCESS OF THE PURCHASE PRICE OF THE PRODUCT. THIS LIMITATION APPLIES TO DAMAGES OF ANY KIND INCLUDING ANY DIRECT OR INDIRECT DAMAGES, LOST PROFITS, LOST SAVINGS OR OTHER SPECIAL, INCIDENTAL, EXEMPLARY OR CONSEQUENTIAL DAMAGES WHETHER ARISING OUT OF THE USE OF OR INABILITY TO USE SUCH PRODUCT, EVEN IF PREMIO COMPUTER, INC. OR AN AUTHORIZED PREMIO COMPUTER, INC. REPRESENTATIVE OR DEALER HAS BEEN ADVISED OF THE POSSIBILITY OF SUCH DAMAGES OR OF ANY CLAIM BY ANY OTHER PARTY. SOME STATES DO NOT ALLOW THE EXCLUSION OR LIMITATION OF INCIDENTAL OR CONSEQUENTIAL DAMAGES FOR SOME PRODUCTS, SO THE ABOVE LIMITATIONS OR EXCLUSIONS MAY NOT APPLY TO YOU. PREMIO COMPUTER, INC. AUTHORIZED RESELLERS AND SERVICE PROVIDERS/PARTNERS MAY BE CHANGED, ADDED OR DELETED, WITHOUT NOTICE OR LIABILITY. PREMIO COMPUTER, INC. DISCLAIMS ANY AUTHORIZED RESELLERS AND SERVICE PROVIDER/PARTNER TO THE PROGRAM. THIS WARRANTY GIVES YOU SPECIFIC LEGAL RIGHTS AND YOU MAY ALSO HAVE OTHER RIGHTS WHICH MAY VARY FROM STATE TO STATE.

FCC Standards

The FCC (Federal Communications Commission) restricts the amount of radiation and radio frequency emissions from computing equipment.

This equipment generates and uses radio frequency energy and if not installed and used properly in strict accordance with the operation instructions, reference manuals, and the service manual, may cause interference to radio or television reception.

This equipment can be tested and found to comply with the limits for a Class B digital device pursuant to part 15 of the FCC rules. These limits are designed to provide reasonable protection against harmful interference in a residential installation. This equipment generates, uses, and can radiate radio frequency energy and, if not installed and used in accordance with the instructions, may cause harmful interference to radio communications. However, there is no guarantee that interference will not occur in a particular installation. If this equipment does cause harmful interference to radio or television reception, which can be determined by turning the equipment off and on, then the user is encouraged to try to correct the interference by one or more of the following procedures:

- Reorient or relocate the receiving antenna.
- Increase the separation between the equipment and receiver.
- Connect the equipment into an outlet on a circuit different from that to which the receiver is connected.
- Consult the dealer or an experienced radio/TV technician for help.

Important Safety Instructions

These instructions are provided by Underwriters Laboratories, Inc.

1. Read all of these instructions and save them for later reference.
2. Follow all warnings and instructions marked on the product.
3. Unplug this product from the wall outlet before cleaning. Do not use liquid or aerosol cleaners. Use a damp cloth for cleaning.
4. Do not use this product near water.
5. Do not place this product on an unstable cart, stand or table. The product may fall, causing serious damage to the product.
6. Slots and openings on the cabinet and the back or bottom are provided for ventilation. To ensure reliable operation of the product and to protect it from overheating, do not block or cover these openings. The openings should never be blocked by placing the product on a bed, sofa, rug or other similar surface. This product should never be placed near or over a radiator or heat register. This product should not be placed in a built-in installation unless proper ventilation is provided.
7. This product should be operated from the type of power source indicated on the marking label. If you are not sure of the type of power available, consult your dealer or local power company.
8. This product is equipped with a 3-wire grounding-type plug, a plug having a third (grounding) pin. This plug will only fit into a grounding-type power outlet. This is a safety feature. If you are unable to insert the plug into the outlet, contact your electrician to replace your obsolete outlet. Do not defeat the safety purpose of the grounding-type plug.
9. Do not allow anything to rest on the power cord. Do not locate this product where the cord will be walked on.
10. If an extension cord is used with this product, make sure that the total of the ampere ratings on the products plugged into the extension cord do not exceed the extension cord ampere rating. Also, make sure that the total of all products plugged into the wall outlet does not exceed 15 amperes.
11. Never push objects of any kind into this product through cabinet slots as they may touch dangerous voltage points or short out parts that could result in a risk of fire or electric shock. Never spill liquid of any kind on the product.

12. Except as explained elsewhere in this manual, don't attempt to service this product yourself. Opening and removing those covers that are marked "Do Not Remove" may expose you to dangerous voltage points or other risks. Refer all servicing on those compartments to service personnel.
13. Unplug this product from the wall outlet and refer servicing to qualified service personnel under the following conditions:
 - A. When the power cord or plug is damaged or frayed.
 - B. If liquid has been spilled into the product.
 - C. If the product has been exposed to rain or water.
 - D. If the product does not operate normally when the operating instructions are followed. Adjust only those controls that are covered by the operating instructions since improper adjustment of other controls may result in damage and will often require extensive work by a qualified technician to restore the product to normal operation.
 - E. If the product has been dropped or the cabinet has been damaged.
 - F. If the product exhibits a distinct change in performance, indicating a need for service.

FCC Compliance Statement:

<p style="text-align: center;">DECLARATION OF CONFORMITY <small>Per FCC Part 2 Section 2.107(a)</small></p> <p style="text-align: center;">FCC</p> <p>Responsible Party Name: G.B.T. INC. Address: 18305 Valley Blvd., Suite#A LA Puente, CA 91744 Phone/Fax No: (818) 854-9338 / (818) 854-9339</p> <p>hereby declares that the product Product Name: Mother Board Model Number: GA-7DX</p> <p>Conforms to the following specifications: FCC Part 15, Subpart B, Section 15.107(a) and Section 15.109(a), Class B Digital Device</p> <p>Supplementary Information: This device complies with part 15 of the FCC Rules. Operation is subject to the following two conditions: (1) This device may not cause harmful interference and (2) this device must accept any interference received, including that may cause undesired operation.</p> <p>Representative Person's Name: <u>ERIC LU</u> Signature: <u>Eric Lu</u> Date: <u>Jan. 27, 2001</u></p>

This equipment has been tested and found to comply with limits for a Class B digital device, pursuant to Part 15 of the FCC rules. These limits are designed to provide reasonable protection against harmful interference in residential installations. This equipment generates, uses, and can radiate radio frequency energy, and if not installed and used in accordance with the instructions, may cause harmful interference to radio communications. However, there is no guarantee that interference will not occur in a particular installation. If this equipment does cause interference to radio or television equipment reception, which can be

determined by turning the equipment off and on, the user is encouraged to try to correct the interference by one or more of the following measures:

- Reorient or relocate the receiving antenna
- Move the equipment away from the receiver
- Plug the equipment into an outlet on a circuit different from that to which the receiver is connected
- Consult the dealer or an experienced radio/television technician for additional suggestions

You are cautioned that any change or modifications to the equipment not expressly approve by the party responsible for compliance could void Your authority to operate such equipment.

This device complies with Part 15 of the FCC Rules. Operation is subjected to the following two conditions 1) this device may not cause harmful interference and 2) this device must accept any interference received, including interference that may cause undesired operation.

Declaration of Conformity

We, Manufacturer/Importer
(full address)

G.B.T. Technology Trading GmbH
Ausschlagler Weg 41, 1F, 20537 Hamburg, Germany

declare that the product
(description of the apparatus, system, installation to which it refers)

Mother Board
GA-7DX

is in conformity with
(reference to the specification under which conformity is declared)
in accordance with 89/336 EEC-EMC Directive

- | | | | |
|---|--|--|--|
| <input type="checkbox"/> EN 55011 | Limits and methods of measurement of radio disturbance characteristics of industrial, scientific and medical (ISM) high frequency equipment | <input type="checkbox"/> EN 61000-3-2*
<input checked="" type="checkbox"/> EN60555-2 | Disturbances in supply systems caused by household appliances and similar electrical equipment "Harmonics" |
| <input type="checkbox"/> EN55013 | Limits and methods of measurement of radio disturbance characteristics of broadcast receivers and associated equipment | <input type="checkbox"/> EN61000-3-3*
<input checked="" type="checkbox"/> EN60555-3 | Disturbances in supply systems caused by household appliances and similar electrical equipment "Voltage fluctuations" |
| <input type="checkbox"/> EN 55014 | Limits and methods of measurement of radio disturbance characteristics of household electrical appliances, portable tools and similar electrical apparatus | <input checked="" type="checkbox"/> EN 50081-1
<input checked="" type="checkbox"/> EN 50082-1 | Generic emission standard Part 1: Residual, commercial and light industry
Generic immunity standard Part 1: Residual, commercial and light industry |
| <input type="checkbox"/> EN 55015 | Limits and methods of measurement of radio disturbance characteristics of fluorescent lamps and luminaries | <input type="checkbox"/> EN 55081-2 | Generic emission standard Part 2: Industrial environment |
| <input type="checkbox"/> EN 55020 | Immunity from radio interference of broadcast receivers and associated equipment | <input type="checkbox"/> EN 55082-2 | Generic immunity standard Part 2: Industrial environment |
| <input checked="" type="checkbox"/> EN 55022 | Limits and methods of measurement of radio disturbance characteristics of information technology equipment | <input type="checkbox"/> ENV 55104 | Immunity requirements for household appliances tools and similar apparatus |
| <input type="checkbox"/> DIN VDE 0855
<input type="checkbox"/> part 10
<input type="checkbox"/> part 12 | Cabled distribution systems; Equipment for receiving and/or distribution from sound and television signals | <input type="checkbox"/> EN 50091- 2 | EMC requirements for uninterruptible power systems (UPS) |
| <input checked="" type="checkbox"/> CE marking | |  | (EC conformity marking) |

The manufacturer also declares the conformity of above mentioned product with the actual required safety standards in accordance with LVD 73/23 EEC

- | | | | |
|-----------------------------------|---|-------------------------------------|---|
| <input type="checkbox"/> EN 60065 | Safety requirements for mains operated electronic and related apparatus for household and similar general use | <input type="checkbox"/> EN 60950 | Safety for information technology equipment including electrical business equipment |
| <input type="checkbox"/> EN 60335 | Safety of household and similar electrical appliances | <input type="checkbox"/> EN 50091-1 | General and Safety requirements for uninterruptible power systems (UPS) |

Manufacturer/Importer

Signature : Rex Lin
Name : Rex Lin

(Stamp)

Date : Jan. 22, 2001

7DX
AMD Athlon™/Duron™ Socket A Processor
Motherboard

USER'S MANUAL

AMD Athlon™/Duron™ Socket A Processor Motherboard
REV. 4.0 First Edition
R-40-01-010209

How This Manual Is Organized

This manual is divided into the following sections:

1) Revision History	Manual revision information
2) Item Checklist	Product item list
3) Features	Product information & specification
4) Hardware Setup	Instructions on setting up the motherboard
5) Performance & Block Diagram	Product performance & block diagram
6) Suspend to RAM	Instructions on STR installation
7) Four Speaker & SPDIF	Four Speaker & SPDIF introduction
8) DDR	DDR introduction
9) @BIOS™ & EasyTuneIII™	@BIOS™ & EasyTuneIII™ introduction
10) BIOS Setup	Instructions on setting up the BIOS software
11) Appendix	General reference

Table Of Content

Revision History	P.1
Item Checklist	P.2
Feature Summary	P.3
7DX Motherboard Layout	P.5
Page Index for CPU Speed Setup/Connectors/Panel and Jumper Definition	P.6
Performance List	P.24
Block Diagram	P.25
Suspend to RAM Installation (Optional)	P.26
Four Speaker & SPDIF Introduction (Optional)	P.32
DDR Introduction	P.38
@BIOS™ Introduction	P.39
EasyTuneIII™ Introduction	P.40
Memory Installation	P.42
Page Index for BIOS Setup	P.44
Appendix	P.79

Revision History

Revision	Revision Note	Date
3.0	Initial release of the 7DX motherboard user's manual.	Jan. 2001
4.0	Initial release of the 7DX motherboard user's manual.	Feb. 2001

The author assumes no responsibility for any errors or omissions that may appear in this document nor does the author make a commitment to update the information contained herein. Third-party brands and names are the property of their respective owners.

Feb. 9, 2001 Taipei, Taiwan, R.O.C

Item Checklist

- The 7DX motherboard
- Cable for IDE / floppy device
- Diskettes or CD (TUCD) for motherboard driver & utility
- 7DX user's manual

Feature Summary

Form Factor	<ul style="list-style-type: none"> • 30.4 cm x 23.3 cm ATX size form factor
CPU	<ul style="list-style-type: none"> • AMD Athlon™/Duron™ (K7) Socket A Processor • 256K/64K L2 cache on die • Supports 600MHz ~ 1GHz and above
Chipset	7DX, consisting of: <ul style="list-style-type: none"> • AMD 761 Memory/PCI/AGP Controller • VT82C686B PCI Super-I/O Integrated Peripheral Controller (PSIPC)
Clock Generator	<ul style="list-style-type: none"> • ICS 9248-153 • 200/266 MHz DDR bus speeds • 95/100.7/100.9/103/105/110/115/133 MHz system bus speeds • Supports 100/133 MHz
Memory	<ul style="list-style-type: none"> • 2 184-pin DDR DIMM sockets • Supports PC1600 DDR or PC2100 DDR SDRAM (Support Registered/Unbuffered DDR DIMM) • Supports up to 4GB DRAM (Max) • Supports only 2.5V DDR SDRAM • Supports 72bit ECC type DRAM integrity mode
I/O Control	<ul style="list-style-type: none"> • VT82C686B
Slots	<ul style="list-style-type: none"> • 1 AGP slot supports 2X/4X mode & AGP 2.0 compliant • 5 PCI slots supports 33MHz & PCI 2.2 compliant • 1 AMR (Audio Modem Riser) slot
On-Board IDE	<ul style="list-style-type: none"> • 2 IDE bus master (UDMA 33/ATA 66/ATA100) IDE ports for up to 4 ATAPI devices • Supports PIO mode 3, 4, UDMA33/ATA66/ATA100 IDE & ATAPI CD-ROM
On-Board Peripherals	<ul style="list-style-type: none"> • 1 floppy port supports 2 FDD with 360K, 720K, 1.2M, 1.44M and 2.88M bytes • 1 parallel port supports Normal/EPP/ECP mode • 2 serial ports (COM A & COM B) • 4 USB ports • 1 IrDA connector for IR
Hardware Monitor	<ul style="list-style-type: none"> • CPU/System fan revolution detect • CPU/System temperature detect • System voltage detect • CPU overheat shutdown detect

To be continued...

Features Summary

On-Board Sound	<ul style="list-style-type: none">• Creative CT5880 sound (Optional)• AC'97 CODEC• Line In/Line Out/Mic In/AUX In/CD In/TEL/Game Port / Four Speaker & SPDIF (Optional)
PS/2 Connector	<ul style="list-style-type: none">• PS/2[®] Keyboard interface and PS/2[®] Mouse interface
BIOS	<ul style="list-style-type: none">• Licensed AWARD BIOS, 2M bit flash ROM
Additional Features	<ul style="list-style-type: none">• Support Wake-On-LAN (WOL)• Support Internal / External Modem Ring On• Support USB KB/MS Wake up from S3-S5• Includes 3 fan power connectors• Poly fuse for keyboard over-current protection• Support STR (Suspend-To-RAM) function (Optional)• Support @BIOS[™] and EasyTuneIII[™]

7DX Motherboard Layout

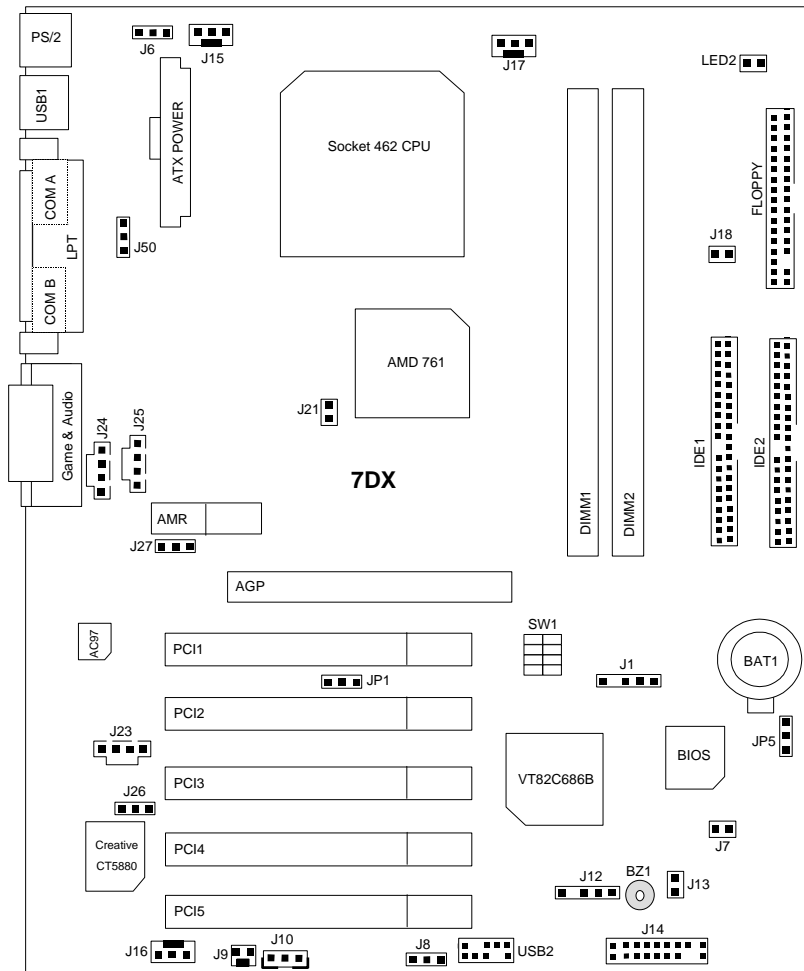

 Page Index for CPU Speed Setup/Connectors/Panel and Jumper Definition	Page
CPU Speed Setup	P.7
SW1	P.7
Connectors	P.8
ATX Power	P.8
COM A / COM B / LPT Port	P.8
Floppy Connector	P.9
Game & Audio Port	P.9
IDE 1(Primary) / IDE 2(Secondary) Connector	P.10
J1 (External SMBUS Header)	P.10
J9 (Ring Power On)	P.11
J10 (Wake On LAN)	P.11
J12 (IR Header)	P.12
J15 (Power Fan)	P.12
J16 (System Fan)	P.13
J17 (CPU Fan)	P.13
J21 (Chip Fan)	P.14
J23 (TEL)	P.14
J24 (CD Audio Line In)	P.15
J25 (AUX_IN)	P.15
LED2 (DIMM LED)	P.16
PS/2 Keyboard & PS/2 Mouse Port	P.16
USB1 (Rear USB Port)	P.17
USB2 (Front USB Connector)	P.17
Panel and Jumper Definition	P.18
BAT1 (Battery)	P.18
J6 (Rear USB Device Wake up Selection)	P.18
J7 (BIOS Write Protect Function)	P.19
J8 (Front Panel USB Device Wake up Selection)	P.19
J13 (Internal Buzzer Selection)	P.20
J14 (2x11 Pins Front Panel)	P.20
J18 (STR Enable /Disable Jumper) [Optional]	P.21
J26&J27 (Primary CODEC Selection)[For AC97 Only]	P.22
J50 (S3 KB/MS Wake up) [Optional]	P.22
JP1 (Registered/Unbuffered DDR DIMM Selection) [Optional]	P.23
JP5 (Clear CMOS Function) [Optional]	P.23

CPU Speed Setup

The system bus speed is selectable at 100-133MHz. The user can select the system bus speed by DIP switch **SW1**.

SW1: CPU Speed Setup

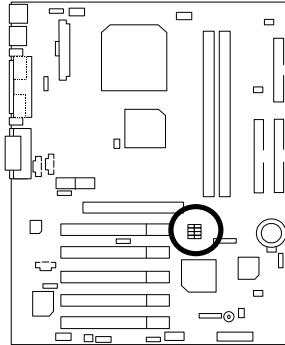

Set System Bus Speed

SW1:

O: ON, X: OFF

CPU	PCI	AGP	1	2	3	4
133	33.3	66.6	O	O	O	O
115	38.3	76.67	X	X	O	X
110	36.67	73.33	X	X	X	X
105	35	70	O	X	X	X
103	34.33	68.67	X	O	X	X
100.9	33.66	67.335	O	X	O	X
100.7	33.57	67.13	O	O	X	X
95	31.67	63.33	X	O	O	X

Connectors

ATX Power

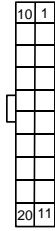
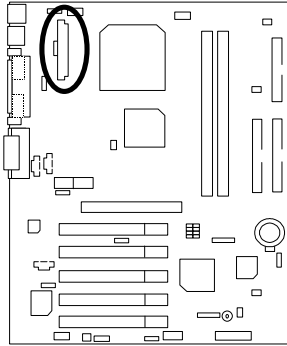

Pin No.	Definition
3,5,7,13, 15,16,17	GND
1,2,11	3.3V
4,6,19,20	VCC
10	+12V
12	-12V
18	-5V
8	Power Good
9	5V SB (stand by+5V)
14	PS-ON (Soft On/Off)

COM A / COM B / LPT Port

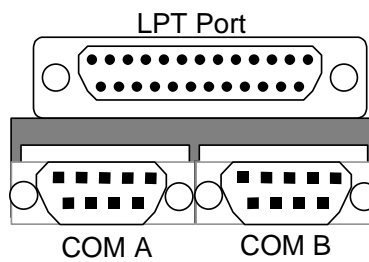
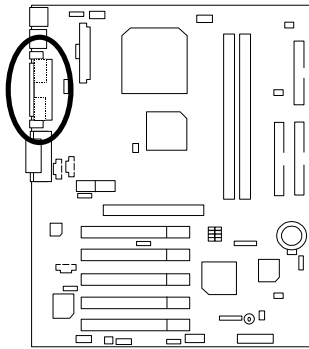

Floppy Connector

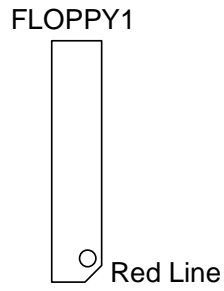
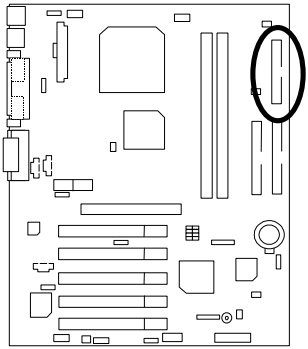

Game & Audio Port

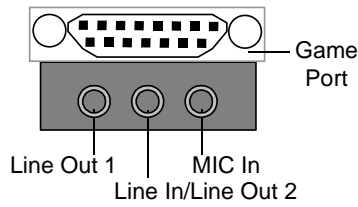
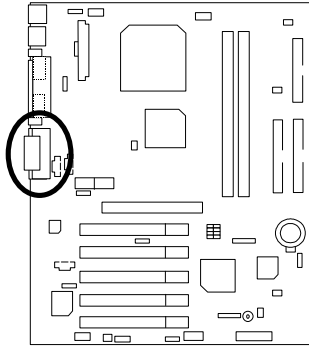

Line Out 1: Line Out or SPDIF (The SPDIF output is capable of providing digital audio to external speakers or compressed AC3 data to an external Dolby digital decoder). To enable SPDIF, simply insert SPDIF connector into Line Out1. Line Out1 will become SPDIF Out automatically. (see page 35 for more information).

To enable Four Speaker (for Creative 5880 audio only), simply follow instructions on page 32 and Line In will become Line Out2 to support second pair of stereo speakers.

IDE1 (Primary), IDE2 (Secondary) Connector

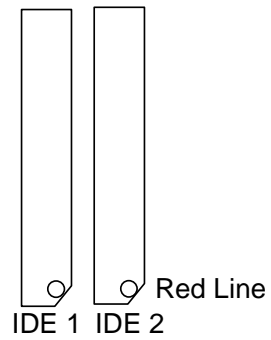
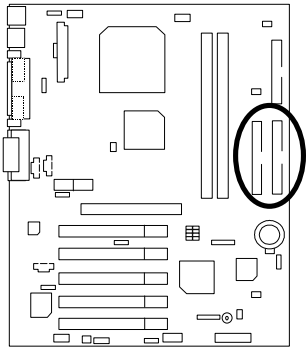

J1: External SMBUS Header

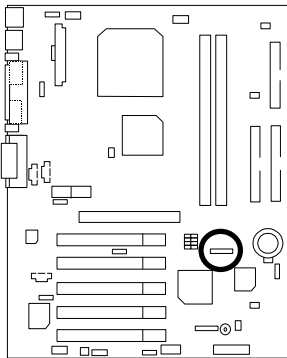

Pin No.	Definition
1	SMB CLK
2	NC
3	GND
4	SMB DATA
5	+5V

J9: Ring Power On (Internal Modem Card Wake Up)

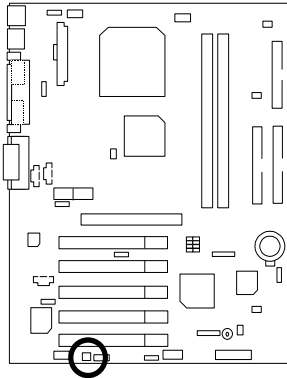

Pin No.	Definition
1	Signal
2	GND

J10: Wake On LAN

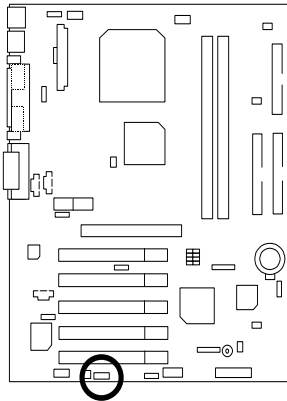

Pin No.	Definition
1	+5V SB
2	GND
3	Signal

J12: IR Header

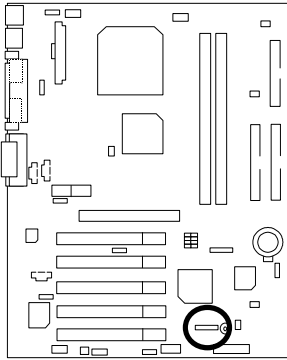

Pin No.	Definition
1	VCC (+5V)
2	NC
3	IR Data Input
4	GND
5	IR Data Output

J15: Power Fan

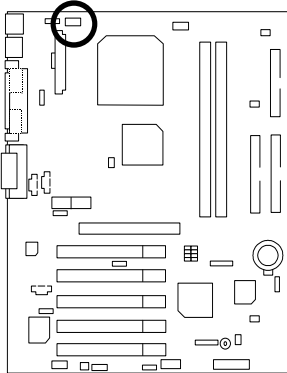

Pin No.	Definition
1	Control
2	+12V
3	NC

J16: System Fan

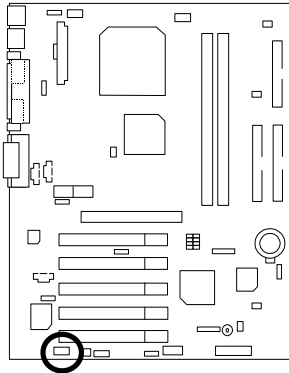

Pin No.	Definition
1	Control
2	+12V
3	SENSE

J17: CPU Fan

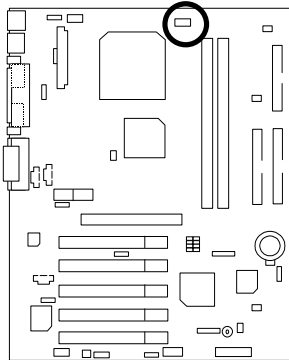

Pin No.	Definition
1	Control
2	+12V
3	SENSE

J21: Chip Fan

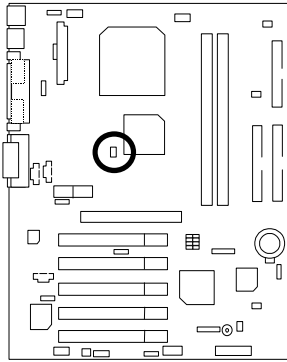

Pin No.	Definition
1	GND
2	+12V

J23 TEL: This connector is for Modem with internal voice connector

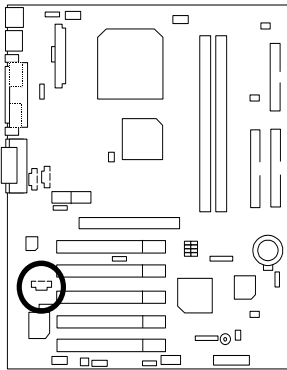

Pin No.	Definition
1	Signal-In
2	GND
3	GND
4	Signal-Out

J24: CD Audio Line In

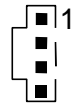
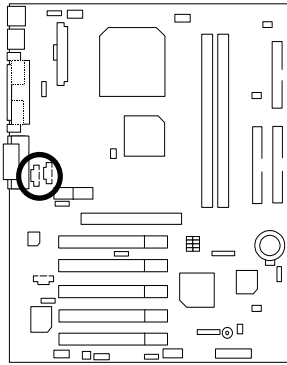

Pin No.	Definition
1	CD-L
2	GND
3	GND
4	CD-R

J25: AUX_IN

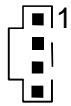
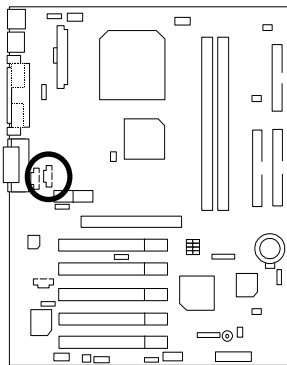

Pin No.	Definition
1	AUX-L
2	GND
3	GND
4	AUX-R

LED2: DIMM LED

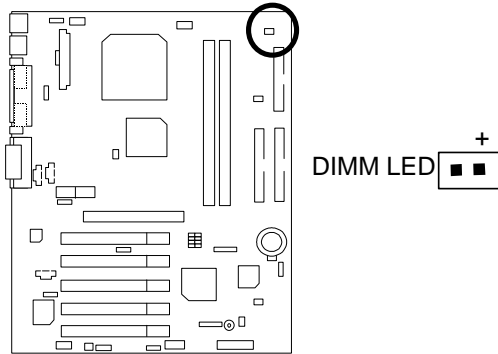

PS/2 Keyboard & PS/2 Mouse Port

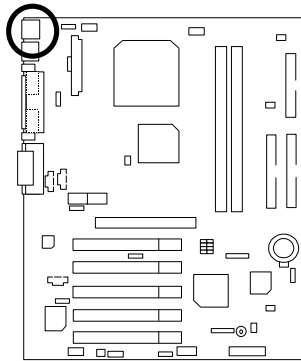

PS/2 Mouse

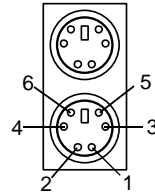

PS/2 Keyboard

PS/2 Mouse/ Keyboard	
Pin No.	Definition
1	Data
2	NC
3	GND
4	VCC(+5V)
5	Clock
6	NC

USB1: Rear USB Port

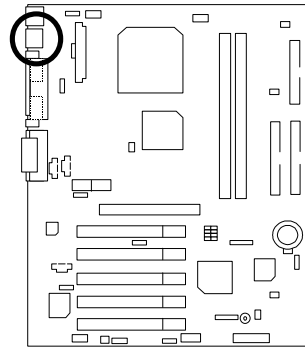

Pin No.	Definition
1	USB V1
2	USB V0
3	USB D1-
4	USB D0-
5	USB D1+
6	USB D0+
7	GND
8	GND

USB 2: Front USB Connector

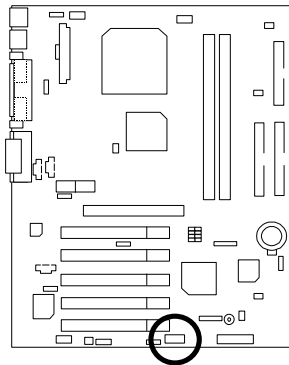

Pin No.	Definition
1	+5V
2	GND
3	USB D2-
4	NC
5	USB D2+
6	USB D3+
7	NC
8	USB D3-
9	GND
10	+5V

Panel And Jumper Definition

BAT1: Battery

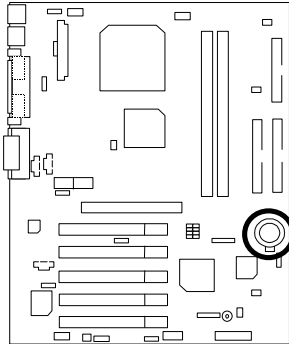

CAUTION

- ⚠ Danger of explosion if battery is incorrectly replaced.
- ⚠ Replace only with the same or equivalent type recommended by the manufacturer.
- ⚠ Dispose of used batteries according to the manufacturer's instructions.

J6: Rear USB Device Wake up Selection (USB Connector → USB1)

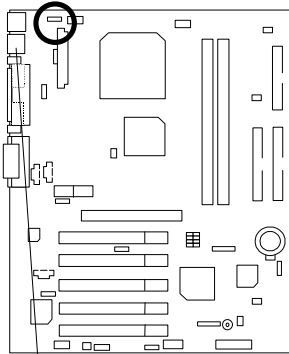

Pin No.	Definition
1-2 close	Rear USB Device Wake up Enable
2-3 close	Rear USB Device Wake up Disable (Default)

USB1

(If you want to use "**USB Dev Wakeup from S3-S5**" function, you have to set the BIOS setting "USB Dev Wakeup from S3-S5" enabled, and the jumper "**J6&J18**" enabled).
 *(Power on the computer and as soon as memory counting starts, press . You will enter BIOS Setup. Select the item "**POWER MANAGEMENT SETUP**", then select "**USB Dev Wakeup from S3-S5: Enabled**". Remember to save the setting by pressing "ESC" and choose the "SAVE & EXIT SETUP" option.)

J7: BIOS Write Protect Function

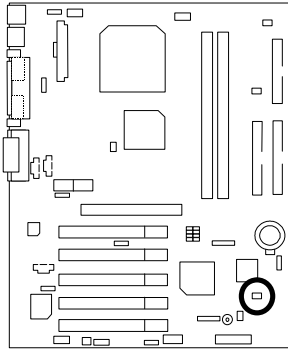

Pin No.	Definition
Close	Write Protect Enable
Open	Write Protect Disable (Default)

Please set Jumper J7 to "Open" to enabled BIOS write function when you update new BIOS or new device.

J8: Front Panel USB Device Wake up Selection (USB Port → USB2)

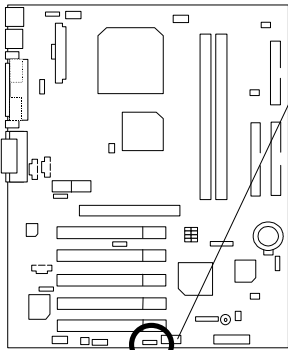

USB2



Pin No.	Definition
1-2 close	Enable FP USB Device Wake up
2-3 close	Disable FP USB Device Wake up (Default)

(If you want to use "USB Dev Wakeup From S3-S5" function, you have to set the BIOS setting "USB Dev Wakeup From S3-S5" enabled, and the jumper "J8&J18" enabled).
 *(Power on the computer and as soon as memory counting starts, press . You will enter BIOS Setup. Select the item "POWER MANAGEMENT SETUP", then select "USB Dev Wakeup from S3-S5: Enabled". Remember to save the setting by pressing "ESC" and choose the "SAVE & EXIT SETUP" option.)

J13: Internal Buzzer Selection

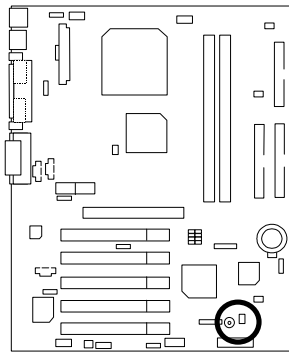

Pin No.	Definition
Close	Internal Buzzer Enable (Default)
Open	Internal Buzzer Disable

J14: 2x11 Pins Front Panel

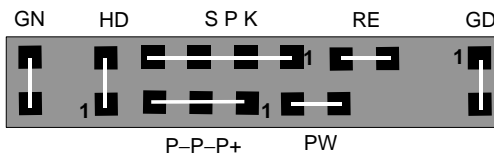
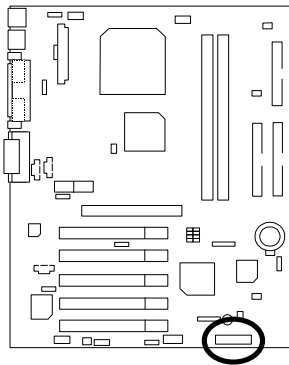

GN (Green Switch)	Open: Normal Operation Close: Entering Green Mode
GD (Green LED)	Pin 1: LED anode(+) Pin 2: LED cathode(-)
HD (IDE Hard Disk Active LED)	Pin 1: LED anode(+) Pin 2: LED cathode(-)
SPK (Speaker Connector)	Pin 1: VCC(+) Pin 2- Pin 3: NC Pin 4: Data(-)
RE (Reset Switch)	Open: Normal Operation Close: Reset Hardware System
P+P-P-(Power LED)	Pin 1: LED anode(+) Pin 2: LED cathode(-) Pin 3: LED cathode(-)
PW (Soft Power Connector)	Open: Normal Operation Close: Power On/Off

J18: STR Enable/Disable Jumper (Optional)

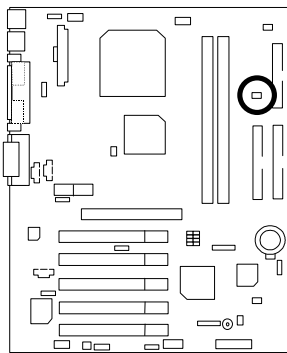

Pin No.	Definition
Open	STR Disable
Close	STR Enable (Default)

J26 & J27: Primary CODEC Selection (For AC97 Only)

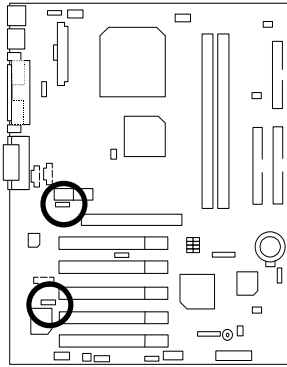

J26	J27	Primary CODEC
1-2 close	1-2 close	On-board AC97(Default)
2-3 close	2-3 close	AMR

J50: S3 KB/MS Wake up (Optional)

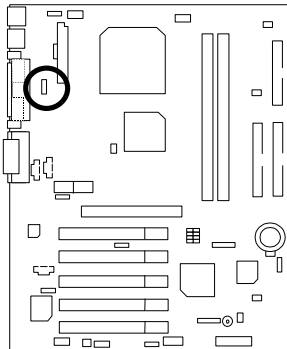

Pin No.	Definition
1-2 close	Normal (Default)
2-3 close	S3 KB/MS Wake up

JP1: Registered/Unbuffered DDR DIMM Selection (Optional)

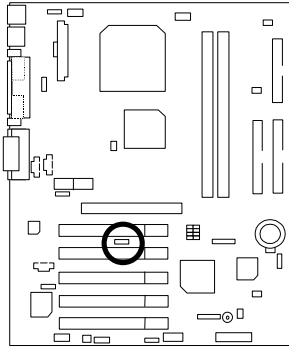

Pin No.	Definition
1-2 close	Support Registered DDR DIMM
2-3 close	Support Unbuffered DDR DIMM (Default)

JP5: Clear CMOS Function (Optional)

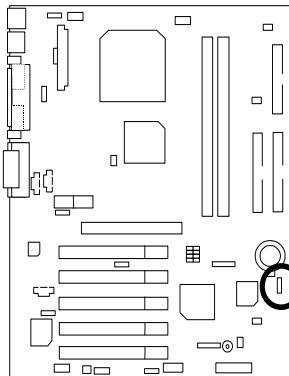

Pin No.	Definition
1-2 Close	Normal (Default)
2-3 Close	Clear CMOS

Performance List

The following performance table lists the results of some popular benchmark testing programs. These data are provided as reference only and in no way guarantee the system shall perform, and there is no responsibility for different testing data at exactly the same level. (The different Hardware & Software configuration will result in different benchmark testing results.)

- CPU AMD Althon™ 1000MHz
- DRAM (64x2) MB DDR (MT8VDDT864AG-265A2)
- CACHE SIZE 384 KB integrated in Althon™
- DISPLAY GA-GF2000 AGP CARD (32MB)
- STORAGE Onboard IDE (IBM DTLA-307060)
- O.S. Windows NT™ 4.0 SPK6
- DRIVER Display Driver at 1024 x 768 x 16bits colors x 75Hz.

Processor	AMD Althon™
	1000MHz (133x7.5)
Winbench99	
CPU mark99	95.3
FPU Winmark 99	5490
Business Disk Winmark 99	8890
Hi-End Disk Winmark 99	21500
Business Graphics Winmark 99	558
Hi-End Graphics Winmark 99	1130
Winstone99	
Business Winstone99	52.8
Hi-End Winstone99	63.4

Block Diagram

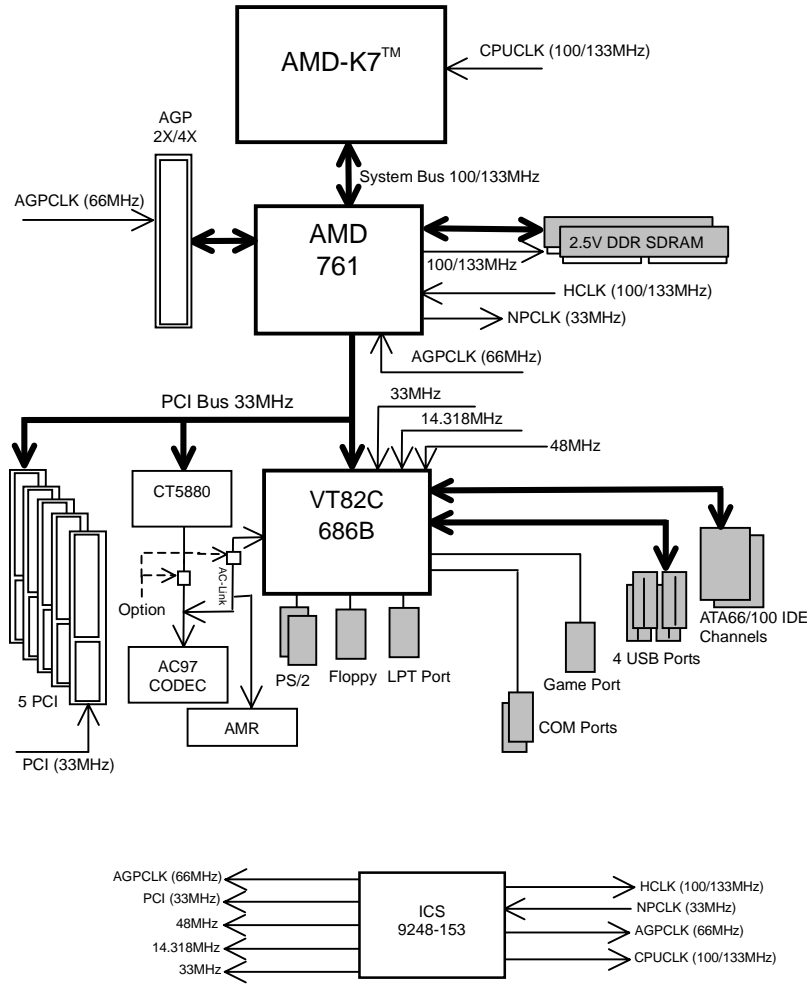

Suspend To RAM Installation (Optional)

A.1 Introduce STR function:

Suspend-to-RAM (STR) is a Windows 98 ACPI sleep mode function. When recovering from STR (S3) sleep mode, the system is able to retrieve the last "state" of the system before it went to sleep and recover to that state in just a few seconds. The "state" is stored in memory (RAM) before the system goes to sleep. During STR sleep mode, the system uses only enough energy to maintain critical information and system functions, primarily the system state and the ability to recognize various "wake up" triggers or signals, respectively.

A.2 STR function Installation

Please use the following steps to complete the STR function installation.

Step-By-Step Setup

Step 1:

To utilize the STR function, the system must be in Windows 98 ACPI mode.

Putting Windows 98 into ACPI mode is fairly easy.

Setup with Windows 98 CD:

- A. Insert the Windows 98 CD into your CD-ROM drive, select Start, and then Run.
- B. Type (without quotes) "**D:\setup**" in the window provided. Hit the enter key or click OK.
- C. After setup completes, remove the CD, and reboot your system
(This manual assumes that your CD-ROM device drive letter is D:).

Step 2:

(If you want to use STR Function, please set jumper J18 Closed.)

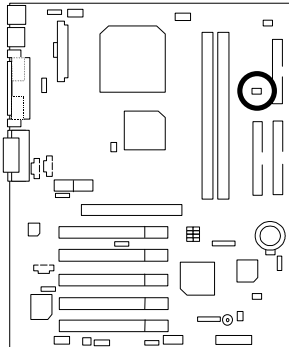

Pin No.	Definition
Open	STR Disable
Close	STR Enable (Default)

Step 3:

Power on the computer and as soon as memory counting starts, press . You will enter BIOS Setup. Select the item **"POWER MANAGEMENT SETUP"**, then select **"ACPI Sleep Type: S3 (STR)"**. Remember to save the settings by pressing "ESC" and choose the **"SAVE & EXIT SETUP"** option.

Congratulation! You have completed the installation and now can use the STR function.

A.3 How to put your system into STR mode?

There are two ways to accomplish this:

1. Choose the "Stand by" item in the "Shut Down Windows" area.
 - A. Press the "Start" button and then select "Shut Down"



- B. Choose the "Stand by" item and press "OK"

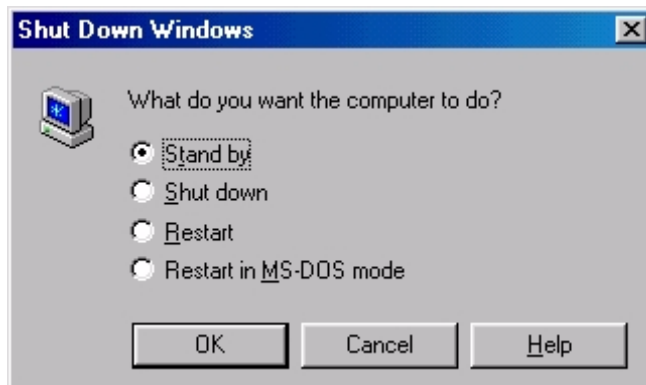

2. Define the system "power on" button to initiate STR sleep mode:

A. Double click "My Computer" and then "Control Panel"



B. Double click the " Power Management" item.

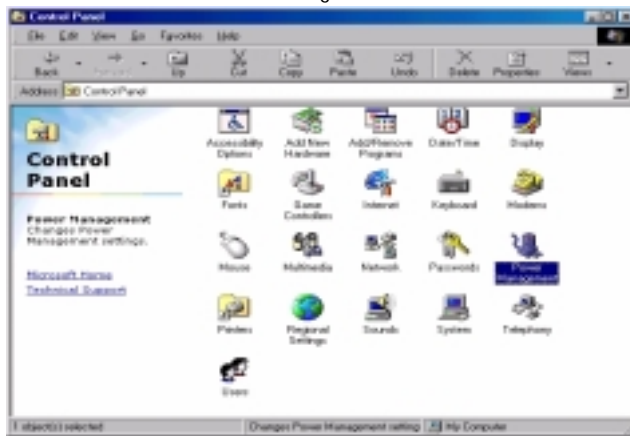

C. Select the "Advanced" tab and "Standby" mode in Power Buttons.

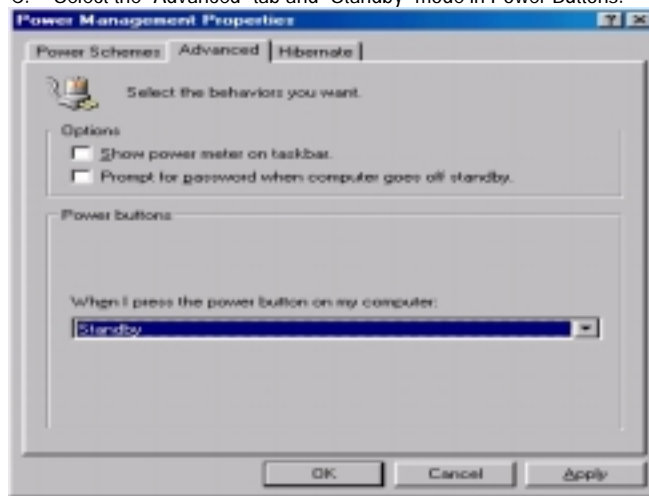

D. Restart your computer to complete setup.

Now when you want to enter STR sleep mode, just momentarily press the "Power on" button.

A.4 How to recover from the STR sleep mode?

There are six ways to "wake up" the system:

1. Press the "Power On" button.
2. Use the "Resume by Alarm" function.
3. Use the "Modem Ring On" function.
4. Use the "Wake On LAN" function.
5. Use the "USB Device Wake Up" function.
6. Use the "KB/MS Wake up from S3" function. (Optional)

A.5 Notices:

1. In order for STR to function properly, several hardware and software requirements must be satisfied:
 - A. Your ATX power supply must comply with the ATX 2.01 specification (provide more than 720 mA 5V Stand-By current).
 - B. Your DDR SDRAM must be DDR-200 or DDR-266 compliant.
2. The DIMM LED will be illuminated when your system has power for memory.

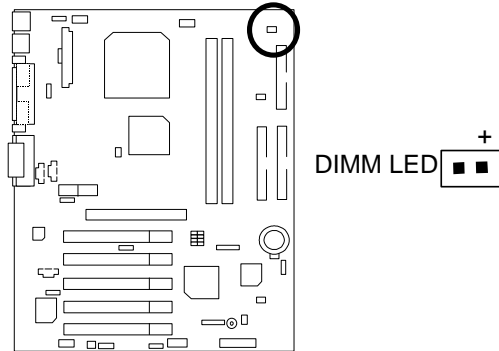

Four Speaker & SPDIF Introduction (Optional)

Four Speaker Introduction

A. What is Four Speaker?

The Creative CT5880 audio chip can support up to 4 speaker output. If you select "Four speaker out", Line In will be reconfigured as another line out to support a second pair of speakers.

B. How to use Four Speaker?

Microsoft Windows 98 Second Edition setup procedure:

- a. Click the audio icon along the task bar and select "Configure 3D Audio"

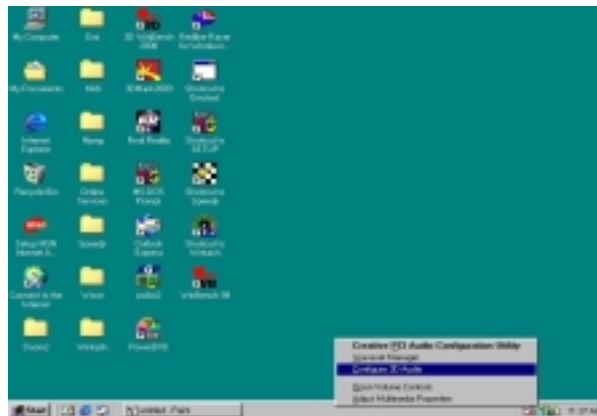

- b. Select two speaker (Default)



- c. Select "Four speaker" item.

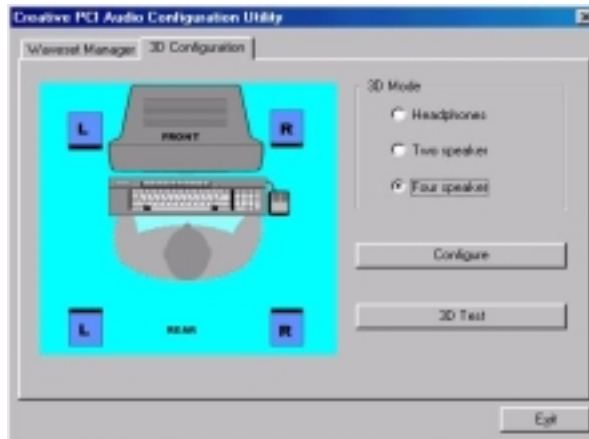

Microsoft Windows Me setup procedure:

- a. Go to "Control Panel"

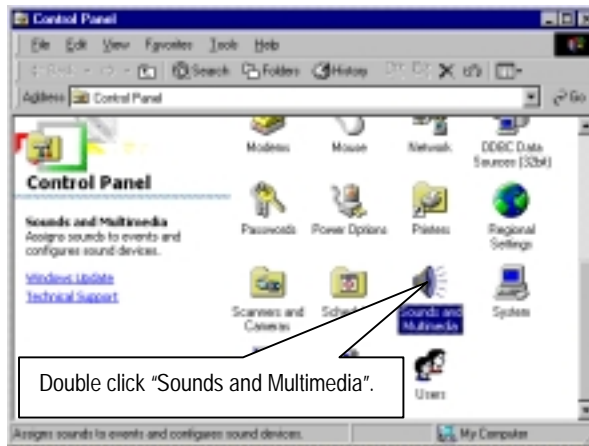

b. Select "Audio" Page, and click "Advanced" button.

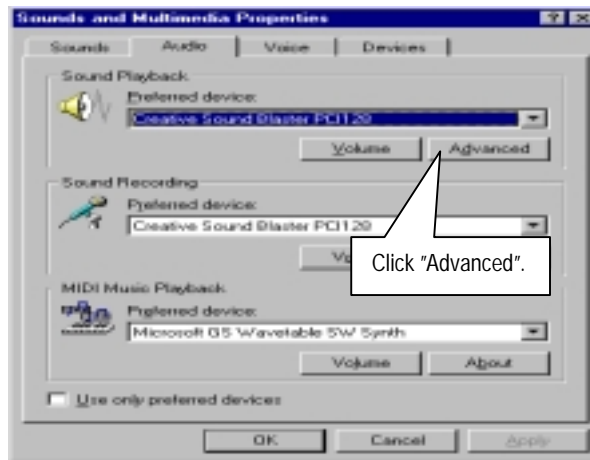

c. Select "Quadrasonic Speakers" and click ok.



C. Four Speaker Application

The four speaker function will only be supported in application softwares that use Microsoft DirectX and Creative EAX, for example, the game titles, software DVD player and MP3 player.

SPDIF Introduction

A. What is SPDIF?

The SPDIF output is capable of providing digital audio to external speakers or compressed AC3 data to an external Dolby digital decoder.

B. How to use SPDIF?

- a. Click your mouse right button in "My Computer" and select the "Properties" item.

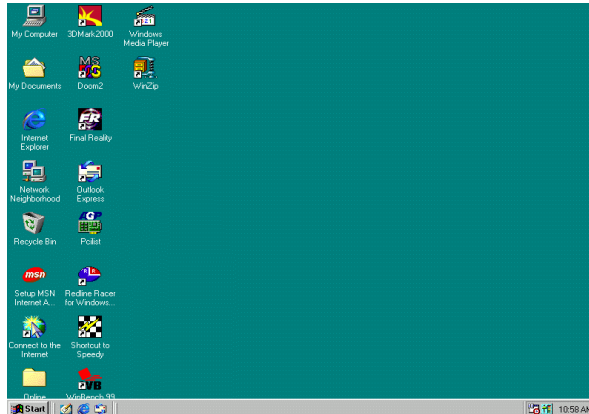

- b. Click "Device Manager" item.

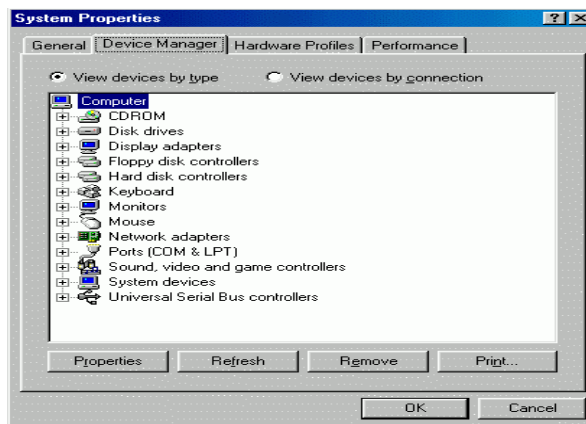

- c. Click "Sound, video and game controllers" item and select the "Creative Sound Blaster PCI128" item.

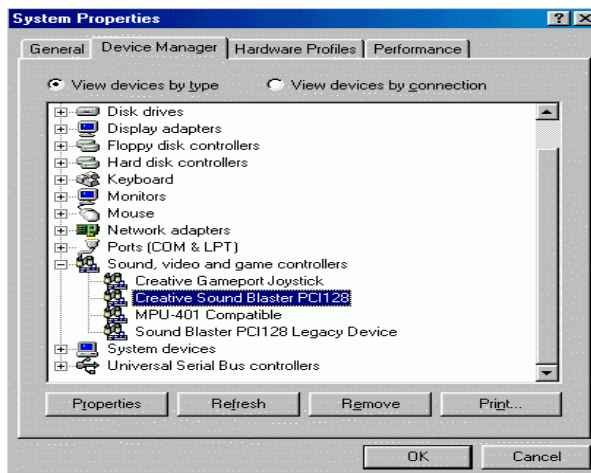

- d. Click "Settings" item and select the "Output Mode" item.

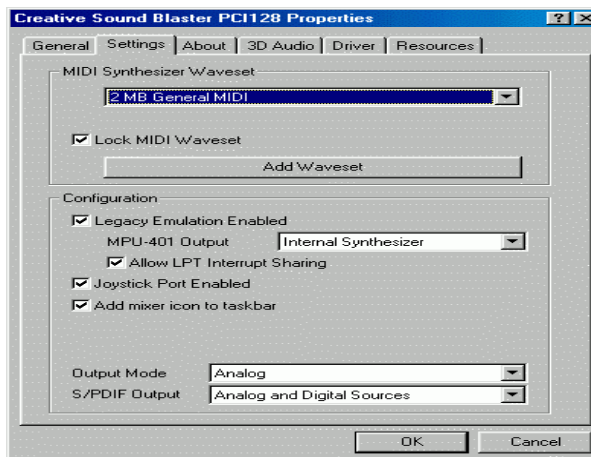

e. Click "Digital" item, Line Out will be reconfigure to SPDIF Out.

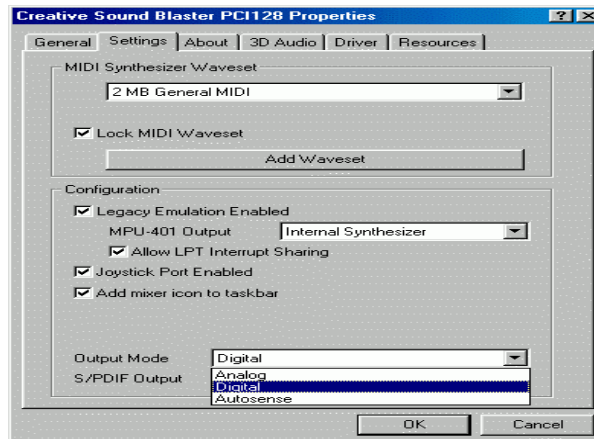

f. Recommend you to select "Autosense", It will automatically detect the type (mono or stereo) of the audio connector that you plug into Line Out audio jack, then configure Line Out to either SPDIF or Speaker accordingly.

DDR Introduction

Established on the existing SDRAM industry infrastructure, DDR (Double Data Rate) memory is a high performance and cost-effective solution that allows easy adoption for memory vendors, OEMs and system integrators.

DDR memory is a sensible evolutionary solution for the PC industry that builds on the existing SDRAM infrastructure, yet makes awesome advances in solving the system performance bottleneck by doubling the memory bandwidth. DDR SDRAM will offer a superior solution and migration path from existing SDRAM designs due to its availability, pricing and overall market support. PC2100 DDR memory (DDR266) doubles the data rate through reading and writing at both the rising and falling edge of the clock, achieving data bandwidth 2X greater than PC133 when running with the same DRAM clock frequency. With peak bandwidth of 2.1GB per second, DDR memory enables system OEMs to build high performance and low latency DRAM subsystems that are suitable for servers, workstations, high-end PC's and value desktop SMA systems. With a core voltage of only 2.5 Volts compared to conventional SDRAM's 3.3 volts, DDR memory is a compelling solution for small form factor desktops and notebook applications.

@BIOS™ Introduction

Gigabyte announces @BIOS™ Windows BIOS live update utility



Have you ever updated BIOS by yourself? Or like many other people, you just know what BIOS is, but always hesitate to update it? Because you think updating newest BIOS is unnecessary and actually you don't know how to update it.

Maybe not like others, you are very experienced in BIOS updating and spend quite a lot of time to do it. But of course you don't like to do it too much. First, download different BIOS from website and then switch the operating system to DOS mode. Secondly, use different flash utility to update BIOS. The above process is not a interesting job. Besides, always be carefully to store the BIOS source code correctly in your disks as if you update the wrong BIOS, it will be a nightmare.

Certainly, you wonder why motherboard vendors could not just do something right to save your time and effort and save you from the lousy BIOS updating work? Here it comes! Now Gigabyte announces @BIOS™--the first Windows BIOS live update utility. This is a smart BIOS update software. It could help you to download the BIOS from internet and update it. Not like the other BIOS update software, it's a Windows utility. With the help of "@BIOS™", BIOS updating is no more than a click.

Besides, no matter which mainboard you are using, if it's a Gigabyte's product*, @BIOS™ help you to maintain the BIOS. This utility could detect your correct mainboard model and help you to choose the BIOS accordingly. It then downloads the BIOS from the nearest Gigabyte ftp site automatically. There are several different choices: you could use "Internet Update" to download and update your BIOS directly. Or you may want to keep a backup for your current BIOS, just choose "Save Current BIOS" to save it first. You make a wise choice to use Gigabyte, and @BIOS™ update your BIOS smartly. You are now worry free from updating wrong BIOS, and capable to maintain and manage your BIOS easily. Again, Gigabyte's innovative product erects a milestone in mainboard industries.

For such a wonderful software, how much it costs? Impossible! It's free! Now, if you buy a Gigabyte's motherboard, you could find this amazing software in the attached driver CD. But please remember, connected to internet at first, then you could have a internet BIOS update from your Gigabyte @BIOS™.

EasyTuneIII™ Introduction

Gigabyte announces EasyTuneIII™ Windows overdrive utility



“Overdrive” might be one of the most common issues in computer field. But have many users ever tried it? The answer is probably “no”. Because “overdrive” is thought to be very difficult and includes a lot of technical know-how, sometimes “overdrive” is even considered as special skills found only in some enthusiasts.

But as to the experts in “overdrive”, what’s the truth? They may spend quite a lot of time and money to study, try and use many different hardware and software tools to do “overdrive”. And even with these technologies, they still learn that it’s quite a risk because the safety and stability of an “overdrive” system is unknown.

Now everything is different because of a Windows overdrive utility EasyTuneIII™ --announced by Gigabyte. This utility has totally changed the gaming rule of “overdrive”. This is the first overdrive utility suitable for both normal and power users. Users can choose either “Easy Mode” or “Advanced Mode” to run “overdrive” at their convenience. For users who choose “Easy Mode”, they just need to click “Auto Optimize” to have auto and immediate CPU overclocking. This software will then overdrive CPU speed automatically with the result being shown in the control panel. If someone prefers to “overdrive” by oneself, there is also another choice. Click “Advanced Mode” to enjoy “sport drive” class overclocking. In “Advanced Mode”, one can change the system bus speed in small increments to get ultimate system performance. And no matter which mainboard is used, if it’s a Gigabyte’s product*, EasyTuneIII™ helps to perform the best of system.

Besides, different from other traditional over-clocking methods, EasyTuneIII™ doesn’t require users to change neither BIOS nor hardware switch/ jumper setting; on the other hand, they can do “overdrive” at only one click. Therefore, this is a safer way for “overdrive” as nothing is changed on software or hardware. If user runs EasyTuneIII™ over system’s limitation, the biggest lost is only to restart the computer again and the side effect is then well controlled. Moreover, if one well-performed system speed been tested in EasyTuneIII™, user can “Save” this bus speed and “Load” it in next time. Obviously, Gigabyte EasyTuneIII™ has already turned the “overdrive” technology toward to a newer generation.

This wonderful software is now free bundled in Gigabyte motherboard attached driver CD. Users may make a test drive of "EasyTuneIII™" to find out more amazing features by themselves.

For further technical information, please link to: <http://www.gigabyte.com.tw>

※ Note: If your TUCD version is 1.6 or below, please visit our website and download the latest EasyTuneIII™ version.

Memory Installation

The motherboard has 2 dual inline memory module (DIMM) sockets. The BIOS will automatically detects memory type and size. To install the memory module, just push it vertically into the DIMM Slot .The DIMM module can only fit in one direction due to the notch. Memory size can vary between sockets.

Total Memory Sizes With Registered DDR DIMM

Devices used on DIMM	1 DIMM (2Rows) x64/x72	2 DIMMs (2Rows each) x64/x72
64 Mbit (4Mx4x4 banks)	256 MBytes	512 MBytes
64 Mbit (2Mx8x4 banks)	128 MBytes	256 MBytes
64 Mbit (1Mx16x4 banks)	64 MBytes	128 MBytes
128 Mbit (8Mx4x4 banks)	512 MBytes	1 GBytes
128 Mbit (4Mx8x4 banks)	256 MBytes	512 MBytes
128 Mbit (2Mx16x4 banks)	128 MBytes	256 MBytes
256 Mbit (16Mx4x4 banks)	1 GBytes	2 GBytes
256 Mbit (8Mx8x4 banks)	512 MBytes	1 GBytes
256 Mbit (4Mx16x4 banks)	256 MBytes	512 MBytes
512 Mbit (32Mx4x4 banks)	2 GBytes	4 GBytes
512 Mbit (16Mx8x4 banks)	1 GBytes	2 GBytes
512 Mbit (8Mx16x4 banks)	512 MBytes	1 GBytes

7DX Motherboard

Total Memory Sizes With Unbuffered DDR DIMM

Devices used on DIMM	1 DIMM (2Rows) x64/x72	2 DIMMs (2Rows each) x64/x72
64 Mbit (2Mx8x4 banks)	128 MBytes	256 MBytes
64 Mbit (1Mx16x4 banks)	64 MBytes	128 MBytes
128 Mbit (4Mx8x4 banks)	256 MBytes	512 MBytes
128 Mbit (2Mx16x4 banks)	128 MBytes	256 MBytes
256 Mbit (8Mx8x4 banks)	512 MBytes	1 GBytes
256 Mbit (4Mx16x4 banks)	256 MBytes	512 MBytes
512 Mbit (16Mx8x4 banks)	1 GBytes	2 GBytes
512 Mbit (8Mx16x4 banks)	512 MBytes	1 GBytes

 Page Index for BIOS Setup	Page
The Main Menu	P.46
Standard CMOS Features	P.49
Advanced BIOS Features	P.53
Advanced Chipset Features	P.55
Integrated Peripherals	P.59
Power Management Setup	P.64
PnP / PCI Configurations	P.68
PC Health Status	P.70
Frequency / Voltage Control	P.72
Load Fail-Safe Defaults	P.74
Load Optimized Defaults	P.75
Set Supervisor / User Password	P.76
Save & Exit Setup	P.77
EXIT Without Saving	P.78

BIOS Setup

BIOS Setup is an overview of the BIOS Setup Interface. The interface allows users to modify the basic system configuration, which is stored in battery-backed CMOS RAM so that the Setup information can be retained when the power is turned off.

ENTERING SETUP

Power ON the computer and press immediately will allow you to enter Setup. If unsuccessful, you can restart the system and try again by pressing the "RESET" bottom on the system case. You may also restart by simultaneously pressing <Ctrl> – <Alt>– keys.

CONTROL KEYS

<↑>	Move to previous item
<↓>	Move to next item
<<←>	Move to the item in the left hand
<→>	Move to the item in the right hand
<Esc>	Main Menu - Quit and not save changes into CMOS Status Page Setup Menu and Option Page Setup Menu - Exit current page and return to Main Menu
<+/PgUp>	Increase the numeric value or make changes
<-/PgDn>	Decrease the numeric value or make changes
<F1>	General help, only for Status Page Setup Menu and Option Page Setup Menu
<F2>	Reserved
<F3>	Reserved
<F4>	Reserved
<F5>	Restore the previous CMOS value from CMOS, only for Option Page Setup Menu
<F6>	Load the default CMOS value from BIOS default table, only for Option Page Setup Menu
<F7>	Load the Optimized Defaults
<F8>	Reserved
<F9>	Reserved
<F10>	Save all the CMOS changes, only for Main Menu

GETTING HELP

Main Menu

The on-line description of the highlighted setup function is displayed at the bottom of the screen.

Status Page Setup Menu / Option Page Setup Menu

Press F1 to pop up a small help window that describes the appropriate keys to use and the possible selections for the highlighted item. To exit the Help Window press <Esc>.

The Main Menu

Once you enter Award BIOS CMOS Setup Utility, the Main Menu (Figure 1) will appear on the screen. The Main Menu allows you to select from nine setup functions and two exit choices. Use arrow keys to select among the items and press <Enter> to accept or enter the sub-menu.

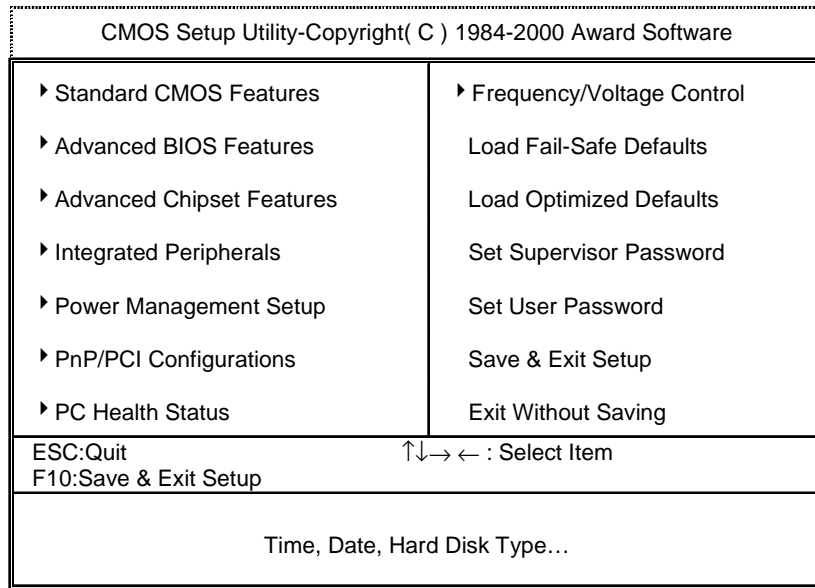

Figure 1: Main Menu

- **Standard CMOS Features**

This setup page includes all the adjustable items in standard compatible BIOS.

- **Advanced BIOS Features**

This setup page includes all the adjustable items of Award special enhanced features.

- **Advanced Chipset Features**

This setup page includes all the adjustable items of chipset special features.

- **Integrated Peripherals**

This setup page includes all onboard peripherals.

- **Power Management Setup**

This setup page includes all the adjustable items of Green function features.

- **PnP/PCI Configurations**

This setup page includes all the adjustable configurations of PCI & PnP ISA resources.

- **PC Health Status**

This setup page is for monitoring system status such as temperature, voltage, and fan speed.

- **Frequency/Voltage Control**

This setup page is for controlling CPU clock and frequency ratio.

- **Load Fail-Safe Defaults**

Load Fail-Safe Defaults option loads preset system parameter values to set the system in its most stable configurations.

- **Load Optimized Defaults**

Load Optimized Defaults option loads preset system parameter values to set the system in its highest performance configurations.

- **Set Supervisor Password**

Set Change or disable password. It allows you to limit access to the system and/or BIOS setup.

- **Set User Password**
Set Change or disable password. It allows you to limit access to the system.
- **Save & Exit Setup**
Save CMOS value settings to CMOS and exit setup.
- **Exit Without Saving**
Abandon all CMOS value changes and exit setup.

Standard CMOS Features

The items in Standard CMOS Setup Menu (Figure 2) are divided into 9 categories. Each category includes none, one or more than one setup items. Use the arrows to highlight the item and then use the <PgUp> or <PgDn> keys to select the value in each item.

CMOS Setup Utility-Copyright(C) 1984-2000 Award Software		
Standard CMOS Features		
Date (mm:dd:yy)	Mon , Feb 21 2000	Item Help
Time (hh:mm:ss)	2 : 31 : 24	
▶ IDE Primary Master	None	Menu Level ▶
▶ IDE Primary Slave	None	Change the Day, month, Year and century
▶ IDE Secondary Master	None	
▶ IDE Secondary Slave	None	
Drive A	1.44M, 3.5 in.	
Drive B	None	
Floppy 3 Mode Support	Disabled	
Video	EGA / VGA	
Halt On	All, But Keyboard	
Base Memory Size	640K	
Extended Memory Size	63488K	
Total Memory	64512K	

↑↓→←:Move Enter:Select +/-/PU/PD:Value F10:Save ESC:Exit F1:General Help
F5:Previous Values F6:Fail-Safe Defaults F7:Optimized Defaults

Figure 2: Standard CMOS Features

- **Date**

The date format is <week>, <month> <day> <year>.

Week	The week, from Sun to Sat, determined by the BIOS and is display-only
Month	The month, Jan. Through Dec.
Day	The day, from 1 to 31 (or the maximum allowed in the month)
Year	The year, from 1994 through 2079

- **Time**

The times format in <hour> <minute> <second>. The time is calculated based on the 24-hour military-time clock. For example, 1 p.m. is 13:00:00.

- **IDE Primary Master / Slave, Secondary Master / Slave**

The category identifies the type of hard disk from drive C to F that has been installed in the computer. There are two settings: Auto, and Manual. Manual: HDD type is user-definable; Auto will automatically detect HDD type.

Note that the specifications of your drive must match with the drive table. The hard disk will not work properly if you enter improper information for this category.

If you select User Type, related information will be asked to enter to the following items. Enter the information directly from the keyboard and press <Enter>. Such information should be provided in the documentation form your hard disk vendor or the system manufacturer.

CYLS.	Number of cylinders
HEADS	number of heads
PRECOMP	write precomp
LANDZONE	Landing zone
SECTORS	number of sectors

If a hard disk has not been installed select NONE and press <Enter>.

- **Drive A / Drive B**

The category identifies the type of floppy disk drive A or drive B that has been installed in the computer.

None	No floppy drive installed
360K, 5.25 in.	5.25 inch PC-type standard drive; 360K byte capacity.
1.2M, 5.25 in.	5.25 inch AT-type high-density drive; 1.2M byte capacity (3.5 inch when 3 Mode is Enabled).
720K, 3.5 in.	3.5 inch double-sided drive; 720K byte capacity
1.44M, 3.5 in.	3.5 inch double-sided drive; 1.44M byte capacity.
2.88M, 3.5 in.	3.5 inch double-sided drive; 2.88M byte capacity.

- **Floppy 3 Mode Support (for Japan Area)**

Disabled	Normal Floppy Drive. (Default value)
Drive A	Drive A is 3 mode Floppy Drive.
Drive B	Drive B is 3 mode Floppy Drive.
Both	Drive A & B are 3 mode Floppy Drives.

- **Video**

The category detects the type of adapter used for the primary system monitor, which must match your video display card and monitor. Although secondary monitors are supported, you do not have to select the type in setup.

EGA/VGA	Enhanced Graphics Adapter/Video Graphics Array. For EGA, VGA, SVGA, or VGA monitor adapters
CGA 40	Color Graphics Adapter, power up in 40 column mode
CGA 80	Color Graphics Adapter, power up in 80 column mode
MONO	Monochrome adapter, includes high resolution monochrome adapters

- **Halt on**

The category determines whether the computer will stop if an error is detected during power up.

NO Errors	The system boot will not stop for any error that may be detected.
All Errors	The system boot will stop on any error detected.
All, But Keyboard	The system boot will not stop for a keyboard error; it will stop for all other errors. (Default value)
All, But Diskette	The system boot will not stop for a disk error; it will stop for all other errors.
All, But Disk/Key	The system boot will not stop for a keyboard or disk error; it will stop for all other errors.

- **Memory**

The category is display-only which is determined by POST (Power On Self Test) of the BIOS.

- **Base Memory Size**

- The POST of the BIOS will determine the amount of base (or conventional) memory installed in the system.

- 640 K for systems with 640 K or more memory installed on the motherboard.

- **Extended Memory Size**

- The BIOS determines how much extended memory is present during the POST.

- This is the amount of memory located above 1 MB in the CPU's memory address map.

Advanced BIOS Features

CMOS Setup Utility-Copyright(C) 1984-2000 Award Software		
Advanced BIOS Features		
Virus Warning	Disabled	Item Help
First Boot Device	Floppy	Menu Level ▶
Second Boot Device	IDE-0	Allows you to
Third Boot Device	CDROM	choose the VIRUS
Floppy Drive Seek	Disabled	Warning feature
BootUp Num-Lock	On	For IDE Hard disk
Password Check	Setup	Boot sector
HDD S.M.A.R.T Capability	Disabled	Protection. If this
		Function is enable
		And someone
		Attempt to write
		Data into this area
		, BIOS will show
		A warning
		Message on
		Screen and alarm
		beep

↑↓→ ←:Move Enter:Select +/-/PU/PD:Value F10:Save ESC:Exit F1:General Help
F5:Previous Values F6:Fail-Safe Defaults F7:Optimized Defaults

Figure 3: Advanced BIOS Features

- **Virus Warning**

If it is set to enable, a warning will be displayed on the screen when there is any attempt to write to the boot sector or partition table of the hard disk drive. The system will halt and the following error message will appear in the mean time. You can run anti-virus program to locate the problem.

Enabled	Activates virus protection and displays a warning message whenever anything attempts to write to the boot sector or the hard disk partition table.
Disabled	No warning message appears when anything attempts to write to the boot sector or hard disk partition table. (Default value)

- **First / Second / Third Boot device**

Floppy	Set your boot device priority to Floppy.
LS120	Set your boot device priority to LS120.
IDE-0-3	Set your boot device priority to IDE-0-3.
SCSI	Set your boot device priority to SCSI.
CDROM	Set your boot device priority to CDROM.
ZIP	Set your boot device priority to ZIP.
Disabled	Disable this function.
LAN	Set your boot device priority to LAN.

- **Floppy Drive Seek**

During POST, BIOS will determine if the floppy disk drive installed is 40 or 80 tracks. 360 type is 40 tracks while 720, 1.2 and 1.44 are all 80 tracks.

Enabled	BIOS searches for floppy disk drive to determine if it is 40 or 80 tracks. Note that BIOS can not differentiate between 720, 1.2 or 1.44 drive type as they are all 80 tracks.
Disabled	BIOS will not search for the type of floppy disk drive by track number. Note that there will not be any warning message if the drive installed is 360. (Default Value)

- **BootUp Num-Lock**

On	Keypad is number keys. (Default value)
Off	Keypad is arrow keys.

- **Password Check**

This category allows you to limit access to the system and Setup, or just to Setup.

System	The user must enter correct password in order to access the system and/or BIOS Setup.
Setup	The user must enter correct password in order to access the system. (Default value)

- **HDD S.M.A.R.T. Capability**

Enabled	Enable HDD S.M.A.R.T. Capability.
Disabled	Disable HDD S.M.A.R.T. Capability. (Default value)

Advanced Chipset Features

CMOS Setup Utility-Copyright(C) 1984-2000 Award Software		
Advanced Chipset Features		
AGP Aperture Size	64	Item Help
AGP Fast Write	Enabled	
AGP Mode	4X	Menu Level ▶
AGP Always Compensate	Enabled	
SDRAM ECC Setting	Disabled	
DRAM Timing setting by	Auto	
X DRAM PH Limit	8 Cycle	
X DRAM Idle Limit	8 Cycle	
X DRAM Trc Timing Value	8 Cycle	
X DRAM Trp Timing Value	3 Cycle	
X DRAM Tras Timing Value	7 Cycle	
X DRAM CAS Latency	2 Cycle	
X SDRAM Trcd Timing Value	3 Cycle	

↑↓→←:Move Enter:Select +/-/PU/PD:Value F10:Save ESC:Exit F1:General Help
F5:Previous Values F6:Fail-Safe Defaults F7:Optimized Defaults

Figure 4: Advanced Chipset Features

- **AGP Aperture Size**

32MB	Set AGP Aperture Size to 32MB.
64MB	Set AGP Aperture Size to 64MB. (Default Value)
128MB	Set AGP Aperture Size to 128MB.
256MB	Set AGP Aperture Size to 256MB.

- **AGP Fast Write**

Enabled	Enable AGP Fast Write function. (Default Value)
Disabled	Disable this function.

- **AGP Mode**

4X	Set AGP Mode to 4X. (Default Value)
1X/2X	Set AGP Mode to 1X/2X.

- **AGP Always Compensate**

Enabled	Enable AGP Always Compensate function. (Default Value)
Disabled	Disable this function.

- **SDRAM ECC Setting**

Disabled	Disable DRAM ECC Setting function. (Default Value)
Check Only	Set DRAM ECC Setting to Check Only. Enable DRAM error checking function.
Correct Error	Set DRAM ECC Setting to Correct Errors. Enable DRAM 1 bit error checking and correcting in CPU/AGP/PCI.
Correct + Scrub	Set DRAM ECC Setting to Correct+Scrub. Enable DRAM 1bit error checking and correcting in CPU/AGP/PCI and DRAM.

- **DRAM Timing setting by**

Auto	Set DRAM Timing setting to Auto. (Default value)
Manual	Set DRAM Timing setting to Manual.

- **DRAM PH Limit**

This function specify the number of consecutive Page-Hit requests to allow before choosing a non-Page-Hit request.

1 Cycle	Set DRAM PH Limit to 1 Cycle.
4 Cycle	Set DRAM PH Limit to 4 Cycle.
8 Cycle	Set DRAM PH Limit to 8 Cycle.
16 Cycle	Set DRAM PH Limit to 16 Cycle.

- **DRAM Idle Limit**

This function specify the number of idle cycles to wait before precharging an idle bank. (Idle cycles are defined as cycles where no valid request is asserted to the MCT.)

0 Cycle	Set DRAM Idle Limit to 0 Cycle.
8 Cycle	Set DRAM Idle Limit to 8 Cycle.
12 Cycle	Set DRAM Idle Limit to 12 Cycle.
16 Cycle	Set DRAM Idle Limit to 16 Cycle.
24 Cycle	Set DRAM Idle Limit to 24 Cycle.
32 Cycle	Set DRAM Idle Limit to 32 Cycle.
48 Cycle	Set DRAM Idle Limit to 48 Cycle.
Disabled	Disable this function.

- **DRAM Trc Timing Value**

This function specify the minimum time from activate to activate of the same bank.

3 Cycle	Set DRAM Trc Timing Value to 3 Cycle.
4 Cycle	Set DRAM Trc Timing Value to 4 Cycle.
5 Cycle	Set DRAM Trc Timing Value to 5 Cycle.
6 Cycle	Set DRAM Trc Timing Value to 6 Cycle.
7 Cycle	Set DRAM Trc Timing Value to 7 Cycle.
8 Cycle	Set DRAM Trc Timing Value to 8 Cycle.
9 Cycle	Set DRAM Trc Timing Value to 9 Cycle.
10 Cycle	Set DRAM Trc Timing Value to 10 Cycle.

- **DRAM Trp Timing Value**

This function specify the delay from precharge command to activate command.

1 Cycle	Set DRAM Trp Timing Value to 1 Cycle.
2 Cycle	Set DRAM Trp Timing Value to 2 Cycle.
3 Cycle	Set DRAM Trp Timing Value to 3 Cycle.
4 Cycle	Set DRAM Trp Timing Value to 4 Cycle.

- **DRAM Tras Timing Value**

This function specifies the minimum bank (active time: time from active to precharge of same bank).

2 Cycle	Set DRAM Tras Timing Value to 2 Cycle.
3 Cycle	Set DRAM Tras Timing Value to 3 Cycle.
4 Cycle	Set DRAM Tras Timing Value to 4 Cycle.
5 Cycle	Set DRAM Tras Timing Value to 5 Cycle.
6 Cycle	Set DRAM Tras Timing Value to 6 Cycle.
7 Cycle	Set DRAM Tras Timing Value to 7 Cycle.
8 Cycle	Set DRAM Tras Timing Value to 8 Cycle.
9 Cycle	Set DRAM Tras Timing Value to 9 Cycle.

- **DRAM CAS Latency**

This function specify the DRAM CAS Latency.

2 Cycle	Set DRAM CAS Latency to 2 Cycle.
2.5 Cycle	Set DRAM CAS Latency to 2.5 Cycle.

- **SDRAM Trcd Timing Value**

This function specifies the delay from the activation of a bank to the time that a read or write command is accepted.

1 Cycle	Set SDRAM Trcd Timing Value to 1 Cycle.
2 Cycle	Set SDRAM Trcd Timing Value to 2 Cycle.
3 Cycle	Set SDRAM Trcd Timing Value to 3 Cycle.
4 Cycle	Set SDRAM Trcd Timing Value to 4 Cycle.

Integrated Peripherals

CMOS Setup Utility-Copyright(C) 1984-2000 Award Software		
Integrated Peripherals		
OnBoard IDE1	Enabled	Item Help
OnBoard IDE2	Enabled	
VGA Boot from	AGP	Menu Level ▶
◆ OnBoard Sound Chip	Enabled	
BIOS Flash Protection	Disabled	
USB Controller 1	Enabled	
USB Controller 2	Enabled	
USB Legacy Support	Disabled	
AC97 Audio	Auto	
AC97 Modem	Auto	
Onboard FDD Controller	Enabled	
Onboard Serial Port 1	Auto	
Onboard Serial Port 2	Auto	
UART 2 Mode	Standard	
※ IR Function Duplex	Half	
※ TX, RX inverting enable	No, Yes	
Onboard Parallel Port	378/IRQ7	
Onboard Parallel Mode	Normal	
* ECP Mode Use DMA	3	
* Parallel Port EPP Type	EPP1.9	
♣ Sound Blaster	Disabled	
♣ SB I/O Base Address	220H	
♣ SB IRQ Select	IRQ 5	
♣ SB DMA Select	DMA 1	
♣ MPU-401	Disabled	
♣ MPU-401 I/O Address	330-333H	
♣ Game Port (200-207H)	Enabled	

↑↓←→:Move Enter:Select +/-/PU/PD:Value F10:Save ESC:Exit F1:General Help
F5:Previous Values F6:Fail-Safe Defaults F7:Optimized Defaults

Figure 5: Integrated Peripherals

- ◆ This item will only be shown when there is sound chip onboard.
- ※ These two items will be available when "UART 2 Mode" is set to HPSIR or ASKIR.
- * These two items will be available when "Onboard Parallel Mode" is set to ECP/EPP.
- ♣ These seven items will not be shown when there is sound chip onboard.

- **OnBoard IDE1**

Enabled	Enable onboard 1st channel IDE port. (Default value)
Disabled	Disable onboard 1st channel IDE port.

- **OnBoard IDE2**

Enabled	Enable onboard 2nd channel IDE port. (Default value)
Disabled	Disable onboard 2nd channel IDE port.

- **VGA Boot from**

PCI Slot	Set VGA Boot from PCI Slot.
AGP	Set VGA Boot from AGP. (Default value)

- **Onboard Sound Chip**

Enabled	Enable Onboard Sound Chip function. (Default Value)
Disabled	Disable this function.

- **BIOS Flash Protection**

Enabled	Enable BIOS Flash Protection.
Disabled	Disable BIOS Flash Protection. (Default Value)

- **USB Controller 1**

Enabled	Enable USB Controller 1. (Default value)
Disabled	Disable USB Controller 1.

- **USB Controller 2**

Enabled	Enable USB Controller 2. (Default value)
Disabled	Disable USB Controller 2.

- **USB Legacy Support**

Enabled	Enable USB Device (Such as USB KB, Mouse) support in Legacy Mode, eg. DOS. Win NT4.0 .
Disabled	Disable OnBoard Legacy Audio. (Default Value)

- **AC97 Audio**

Auto	BIOS will automatically detect onboard AC97 Audio. (Default value)
Disabled	Disable AC97 Audio.

- **AC97 Modem**

Auto	Bios will automatically detect onboard AC97 Modem. (Default value)
Disabled	Disabled AC97 Modem.

- **Onboard FDD Controller**

Enabled	Enable onboard FDD port. (Default value)
Disabled	Disable onboard FDD port.

- **Onboard Serial Port 1**

Auto	BIOS will automatically setup the port 1 address. (Default value)
3F8/IRQ4	Enable onboard Serial port 1 and address is 3F8.
2F8/IRQ3	Enable onboard Serial port 1 and address is 2F8.
3E8/IRQ4	Enable onboard Serial port 1 and address is 3E8.
2E8/IRQ3	Enable onboard Serial port 1 and address is 2E8.
Disabled	Disable onboard Serial port 1.

- **Onboard Serial Port 2**

Auto	BIOS will automatically setup the port 2 address. (Default Value)
3F8/IRQ4	Enable onboard Serial port 2 and address is 3F8.
2F8/IRQ3	Enable onboard Serial port 2 and address is 2F8.
3E8/IRQ4	Enable onboard Serial port 2 and address is 3E8.
2E8/IRQ3	Enable onboard Serial port 2 and address is 2E8.
Disabled	Disable onboard Serial port 2.

- **UART 2 Mode**

Standard	Normal Serial port operation. (Default Value)
HPSIR	Set onboard I/O chip Serial Port B to HPSIR Mode.
ASKIR	Set onboard I/O chip Serial Port B to ASKIR Mode.

- **IR Function Duplex**

Half	Half Duplex IR function. (Default Value)
Full	Full Duplex IR function.

- **TX, RX inverting enable**

No, No	Set TX, RX inverting enable to No, No.
No, Yes	Set TX, RX inverting enable to No, Yes. (Default value)
Yes, No	Set TX, RX inverting enable to Yes, No.
Yes, Yes	Set TX, RX inverting enable to Yes, Yes.

- **Onboard Parallel Port**

378/IRQ7	Enable onboard LPT port and address is 378/IRQ7. (Default Value)
278/IRQ5	Enable onboard LPT port and address is 278/IRQ5.
Disabled	Disable onboard LPT port.
3BC/IRQ7	Enable onboard LPT port and address is 3BC/IRQ7.

- **Onboard Parallel Mode**

Normal	Normal Setting. (Default value)
EPP	Using Parallel port as Enhanced Parallel Port.
ECP	Using Parallel port as Extended Capabilities Port.
ECP/EPP	Using Parallel port as ECP & EPP mode.

- **ECP Mode Use DMA**

3	Set ECP Mode Use DMA to 3. (Default Value)
1	Set ECP Mode Use DMA to 1.

- **Parallel Port EPP Type**

EPP 1.9	Set Parallel Port EPP Type to EPP 1.9. (Default value)
EPP 1.7	Set Parallel Port EPP Type to EPP 1.7.

- **Sound Blaster**

Enabled	Enable Sound Blaster.
Disabled	Disable Sound Blaster. (Default Value)

- **SB I/O Base Address**

220H	Set SB I/O Base Address to 220H. (Default Value)
240H	Set SB I/O Base Address to 240H.
260H	Set SB I/O Base Address to 260H.
280H	Set SB I/O Base Address to 280H.

- **SB IRQ Select**

IRQ 5 / 10. (Default Value: 5)

- **SB DMA Select**

DMA 0 / 1 / 2 / 3. (Default Value: 1)
--

- **MPU-401**

Enabled	Enable MPU-401.
Disabled	Disable MPU-401. (Default Value)

Ps. When Force Feedback joystick is used, MPU-401 needs to be Enable.

- **MPU-401 I/O Address**

330-333H	Set MPU-401 I/O Address to 330-333H. (Default Value)
300-303H	Set MPU-401 I/O Address to 300-303H.
310-313H	Set MPU-401 I/O Address to 310-313H.
320-323H	Set MPU-401 I/O Address to 320-323H.

- **Game Port (200-207H)**

Disabled	Disable Game Port (200-207H).
Enabled	Enable Game Port (200-207H). (Default Value)

Power Management Setup

CMOS Setup Utility-Copyright(C) 1984-2000 Award Software		
Power Management Setup		
		Item Help
ACPI Sleep Type	S1(POS)	
Suspend Time Out (Minute)	Disabled	
Soft-Off by PBTN	Instant-off	Menu Level ▶
System after AC Back	Off	
PME Event Wake Up	Enabled	
USB Dev Wakeup from S3-S5	Disabled	
ModemRingOn/WakeOnLan	Enabled	
MODEM Use IRQ	3	
Resume by RTC Alarm	Disabled	
X Date (of Month) Alarm	0	
X Time (hh:mm:ss) Alarm	0 0 0	
▶IRQ Wakeup Events	Press Enter	
VGA	OFF	
LPT & COM	LPT/COM	
HDD & FDD	ON	
PCI master	OFF	

↑↓→←:Move Enter:Select +/-/PU/PD:Value F10:Save ESC:Exit F1:General Help
F5:Previous Values F6:Fail-Safe Defaults F7:Optimized Defaults

Figure 6: Power Management Setup

- **ACPI Sleep Type**

S1 (POS)	Set ACPI Sleep Type to S1 (Power On Suspend). (Default value)
S3 (STR)	Set ACPI Sleep Type to S3 (Suspend to RAM).

- **Suspend Time Out (Minute)**

Disabled	Disable Suspend Time Out Function. (Default Value)
30 Sec - 1 Hour	Set the timer to enter Suspend Time Out.

- **Soft-off by PBTN**

Instant-off	Soft switch ON/OFF for POWER ON/OFF. (Default value)
Suspend	Soft switch to enter Suspend Mode.

- **System After AC Back**

Last State	System power on depends on the status before AC is lost.
Off	Always in Off state when AC power returns. (Default value)
On	Always power on the system when AC power returns.

- **PME Event Wake Up**

Disabled	Disable PME Event Wake Up.
Enabled	Enable PME Event Wake Up. (Default Value)

- **USB Dev Wakeup from S3-S5**

Enabled	Enable USB Device Wakeup from ACPI S3, S4 and S5 mode.
Disabled	Disable USB Device Wakeup from ACPI S3, S4 and S5 mode. (Default Value)

- **ModemRingOn/WakeOnLan**

Disabled	Disable ModemRingOn/WakeOnLan with #RI.
Enabled	Enable ModemRingOn/WakeOnLan with #RI. (Default Value)

- **MODEM Use IRQ**

NA	Set MODEM Use IRQ to NA.
3	Set MODEM Use IRQ to 3. (Default value)
4	Set MODEM Use IRQ to 4.
5	Set MODEM Use IRQ to 5.
7	Set MODEM Use IRQ to 7.
9	Set MODEM Use IRQ to 9.
10	Set MODEM Use IRQ to 10.
11	Set MODEM Use IRQ to 11.

- **Resume by RTC Alarm**

You can set "Resume by RTC Alarm" item to Enabled and key in date/time to power on system.

Disabled	Disable this function. (Default value)
Enabled	Enable alarm function to POWER ON system or wake up system from sleep mode.

If the default value is Enabled.

Date (of Month) Alarm :	0-31
Time (hh: mm: ss) Alarm :	(0-23) : (0-59) : (0-59)

- **IRQ Activity**

Disabled	Disable this function.
Primary	The resource is used by Primary device. (Default value)
Secondary	The resource is used by Secondary device.

- **IRQ [3-15]**

Disabled	Disable specified IRQ to Wake up system from sleep mode or Reload PM Timer to prevent system to enter sleep mode.
Enabled	Enable specified IRQ to Wake up system from sleep mode or Reload PM Timer to prevent system to enter sleep mode.

- **VGA**

OFF	Disable monitor VGA activity to prevent system to enter sleep mode. (Default value)
ON	Enable monitor VGA activity to prevent system to enter sleep mode.

- **LPT & COM**

LPT/COM	Enable LPT/COM Ports Activity to Wake up system from sleep mode or prevent system to enter sleep mode. (Default value)
NONE	Normal Operation.
LPT	Enable LPT Ports Activity to Wake up system from sleep mode or prevent system to enter sleep mode.
COM	Enable COM Ports Activity to Wake up system from sleep mode or prevent system to enter sleep mode.

- **HDD & FDD**

ON	Enable HDD & FDD Ports Activity to Wake up system from sleep mode or prevent system to enter sleep mode. (Default value)
OFF	Disable HDD & FDD Ports Activity to Wake up system from sleep mode or prevent system to enter sleep mode.

- **PCI master**

ON	Enable PCI master Activity to Wake up system from sleep mode or prevent system to enter sleep mode.
OFF	Disable PCI master Activity to Wake up system from sleep mode or prevent system to enter sleep mode. (Default value)

PnP/PCI Configurations

CMOS Setup Utility-Copyright(C) 1984-2000 Award Software PnP/PCI Configurations		
Reset Configuration Data	Disabled	Item Help
Resources Controlled By	Auto (ESCD) Press Enter	Menu Level ▶
X IRQ Resources		
INT A Assignment	Auto	Default is Disabled.
INT B Assignment	Auto	Select Enabled to
INT C Assignment	Auto	reset Extended System
INT D Assignment	Auto	Configuration Data
		ESCD) when you exit
		Setup if you have
		installed a new add-on
		and the System
		reconfiguration has
		caused such a serious
		conflict that the OS
		cannot boot
↑↓← → Move Enter:Select +/-PU/PD:Value F10:Save ESC:Exit F1:General Help F5:Previous Values F6:Fail-Safe Defaults F7:Optimized Defaults		

Figure 7: PnP/PCI Configurations

- **Reset Configuration Data**

Disabled	Disable this function. (Default value)
Enabled	Enable Reset Configuration Data function.

- **Resources Controlled by**

Manual	User can set the PnP resource (I/O Address, IRQ & DMA channels) used by legacy ISA DEVICE.
Auto(ESCD)	BIOS automatically use these PnP rescuers. (Default value)

- **IRQ (3, 4, 5, 7, 9, 10, 11, 12, 14, 15)**

PCI Device	The resource is used by PCI device. (Default value)
Reserved	Set the resource to reserved.

- **INT A / B / C / D Assignment**

Auto	Will be automatically detected by BIOS. (Default value)
3	Set INT A / B / C / D Assignment to 3.
4	Set INT A / B / C / D Assignment to 4.
5	Set INT A / B / C / D Assignment to 5.
7	Set INT A / B / C / D Assignment to 7.
9	Set INT A / B / C / D Assignment to 9.
10	Set INT A / B / C / D Assignment to 10.
11	Set INT A / B / C / D Assignment to 11.
12	Set INT A / B / C / D Assignment to 12.
14	Set INT A / B / C / D Assignment to 14.
15	Set INT A / B / C / D Assignment to 15.

PC Health Status

CMOS Setup Utility-Copyright(C) 1984-2000 Award Software		
PC Health Status		
Shutdown Temperature	Disabled	Item Help
CPU Warning Temperature	Disabled	Menu Level ▶
CPU Fan Warning	No	
System Fan Warning	No	
Current CPU Temp.	57°C/134°F	
Current System Temp.	31°C/87°F	
CPU Fan Speed	5553 RPM	
System Fan Speed	0 RPM	
Vcore	3.10V	
3.3V	3.31V	
5V	5.10V	
12V	12.42V	

↑↓→←Move Enter:Select +/-PU/PD:Value F10:Save ESC:Exit F1:General Help
F5:Previous Values F6:Fail-Safe Defaults F7:Optimized Defaults

Figure 8: PC Health Status

- **Shutdown Temperature (°C / °F)**

(This function will be effective only for the operating systems that support ACPI Function.)

Disabled	Disable ACPI Shutdown function. (Default Value)
60°C / 140°F	Monitor CPU Temp. , If Temp. > 60°C / 140°F system will automatically power off.
70°C / 158°F	Monitor CPU Temp. , If Temp. > 70°C / 158°F system will automatically power off.
80°C / 176°F	Monitor CPU Temp. , If Temp. > 80°C / 176°F system will automatically power off.
90°C / 194°F	Monitor CPU Temp. , If Temp. > 90°C / 194°F system will automatically power off.

- **CPU Warning Temperature (°C / °F)**

60°C / 140°F	Monitor CPU Temp. at 60°C / 140°F.
70°C / 158°F	Monitor CPU Temp. at 70°C / 158°F.
80°C / 176°F	Monitor CPU Temp. at 80°C / 176°F.
90°C / 194°F	Monitor CPU Temp. at 90°C / 194°F.
Disabled	Disable this function. (Default value)

- **CPU Fan Warning**

No	Disable this function. (Default value)
Yes	Enable CPU Fan Warning function to display warning message when CPU Fan speed is under lower limit RPM.

- **System Fan Warning**

No	Disable this function. (Default value)
Yes	Enable System Fan Warning function to display warning message when System Fan speed is under a lower limit RPM.

- **CPU Temp. (°C / °F)**

Detect CPU Temperature automatically.

- **System Temp. (°C / °F)**

Detect System Temperature automatically.

- **CPU Fan / System Fan Speed (RPM)**

Detect Fan speed status automatically.

- **Current Voltage (V) Vcore / 3.3V / 5V / 12V**

Detect system's voltage status automatically.

Frequency/Voltage Control

CMOS Setup Utility-Copyright(C) 1984-2000 Award Software Frequency/Voltage Control		
ClkGen Spread Spectrum	Enabled	Item Help
CPU Host/PCI Clock	Default	Menu Level ▶
↑↓→←Move Enter:Select +/-/PU/PD:Value F10:Save ESC:Exit F1:General Help F5:Previous Values F6:Fail-Safe Defaults F7:Optimized Defaults		

Figure 9: Frequency/Voltage Control

- **ClkGen Spread Spectrum**

Disabled	Disable this function.
Enabled	Enable Clock Generator Spread Spectrum function to improve CE/FCC. (Default value)

- **CPU Host/PCI Clock**

The table below is shown only when CPU DIP switch setting is below 133MHz:

Default	When CPU Host/PCI Clock setting is set to Default, the clock will depend on DIP switch setting. (Default value)
100/33Mhz	Set CPU Host/PCI Clock to 100/33Mhz.
102/34Mhz	Set CPU Host/PCI Clock to 102/34Mhz.
104/35Mhz	Set CPU Host/PCI Clock to 104/35Mhz.
108/36Mhz	Set CPU Host/PCI Clock to 108/36Mhz.
112/38Mhz	Set CPU Host/PCI Clock to 112/38Mhz.
116/39Mhz	Set CPU Host/PCI Clock to 116/39Mhz.
118/40Mhz	Set CPU Host/PCI Clock to 118/40Mhz.

7DX Motherboard

The table below is shown only when CPU DIP switch setting is 133MHz or above:

Default	When CPU Host/PCI Clock setting is set to Default, the clock will depend on DIP switch setting. (Default value)
133/33Mhz	Set CPU Host/PCI Clock to 133/33Mhz.
134/34Mhz	Set CPU Host/PCI Clock to 134/34Mhz.
135/34Mhz	Set CPU Host/PCI Clock to 135/34Mhz.
137/34Mhz	Set CPU Host/PCI Clock to 137/34Mhz.
139/35Mhz	Set CPU Host/PCI Clock to 139/35Mhz.
143/36Mhz	Set CPU Host/PCI Clock to 143/36Mhz.
145/37Mhz	Set CPU Host/PCI Clock to 145/37Mhz.
149/38Mhz	Set CPU Host/PCI Clock to 149/38Mhz.

Load Fail-Safe Defaults

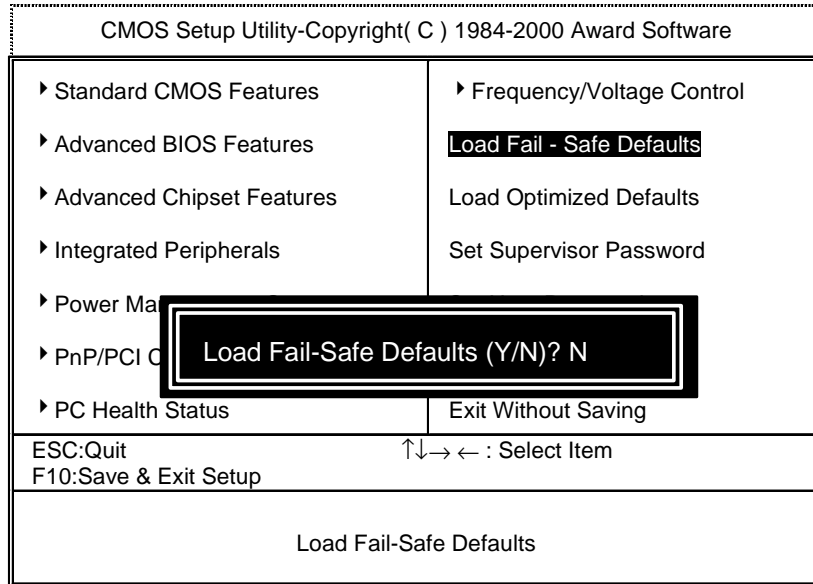

Figure 10: Load Fail-Safe Defaults

- **Load Fail-Safe Defaults**

Fail-Safe defaults contain the most appropriate system parameter values of to configure the system to achieve maximum stability.

Load Optimized Defaults

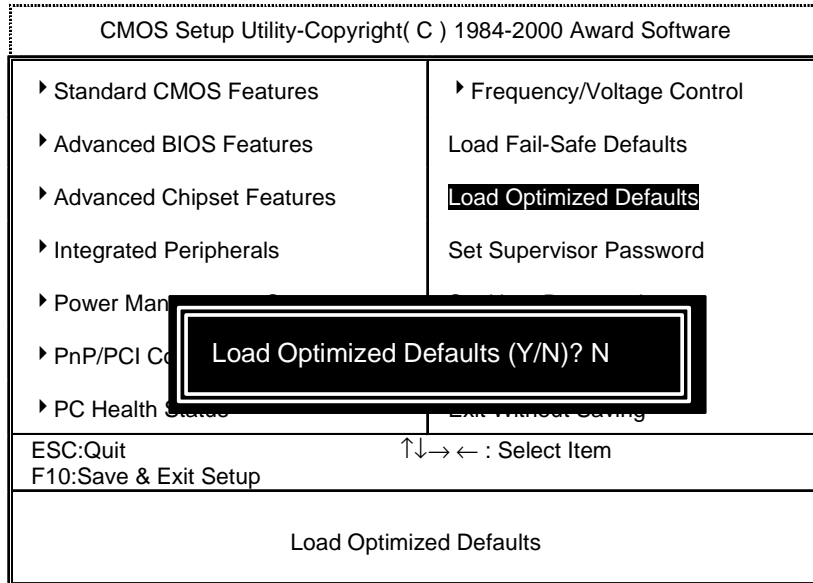

Figure 11: Load Optimized Defaults

- **Load Optimized Defaults**

Optimized defaults contain the most appropriate system parameter values to configure the system to achieve maximum performance.

Set Supervisor / User Password

When you select this function, the following message will appear at the center of the screen to assist you in creating a password.

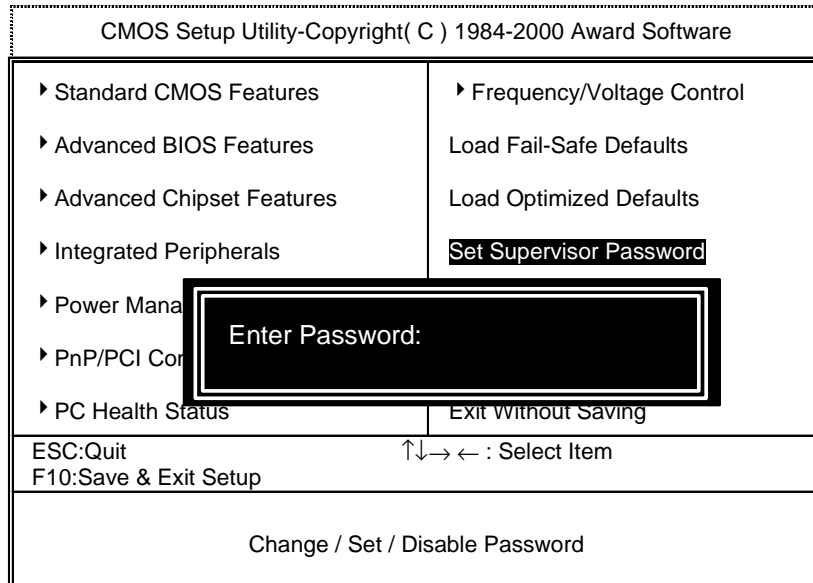

Figure 12: Password Setting

Type the password, up to eight characters, and press <Enter>. You will be asked to confirm the password. Type the password again and press <Enter>. You may also press <Esc> to abort the selection and not enter a password.

To disable password, just press <Enter> when you are prompted to enter password. A message **"PASSWORD DISABLED"** will appear to confirm the password being disabled. Once the password is disabled, the system will boot and you can enter Setup freely.

The BIOS Setup program allows you to specify two separate passwords: a **SUPERVISOR PASSWORD** and a **USER PASSWORD**. When disabled, anyone may access all BIOS Setup program function. When enabled, the Supervisor password is required for entering the BIOS Setup program and having full configuration fields, the User password is required to access only basic items.

If you select **"System"** at **"Password Check"** in Advanced BIOS Feature Menu, you will be prompted for the password every time the system is rebooted or any time you try to enter Setup Menu.

If you select **"Setup"** at **"Password Check"** in Advanced BIOS Feature Menu, you will be prompted only when you try to enter Setup.

Save & Exit Setup

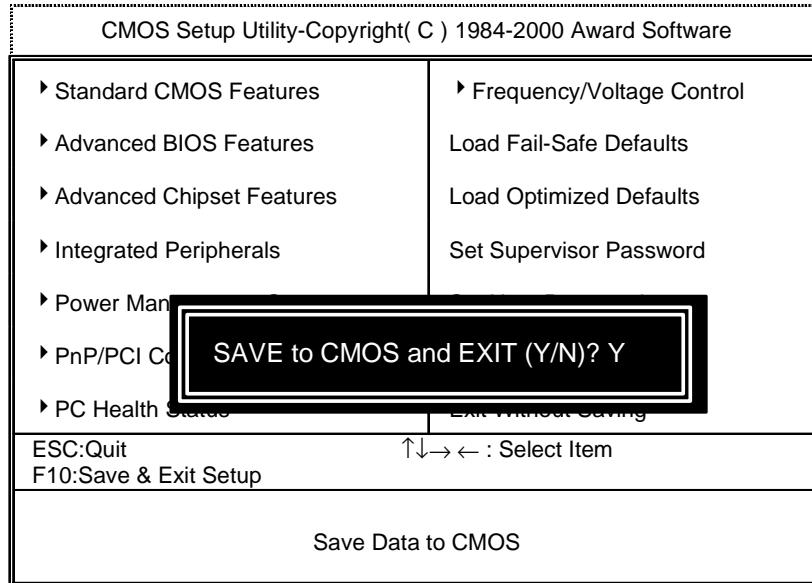

Figure 13: Save & Exit Setup

Type "Y" will quit the Setup Utility and save the user setup value to RTC CMOS.

Type "N" will return to Setup Utility.

Exit Without Saving

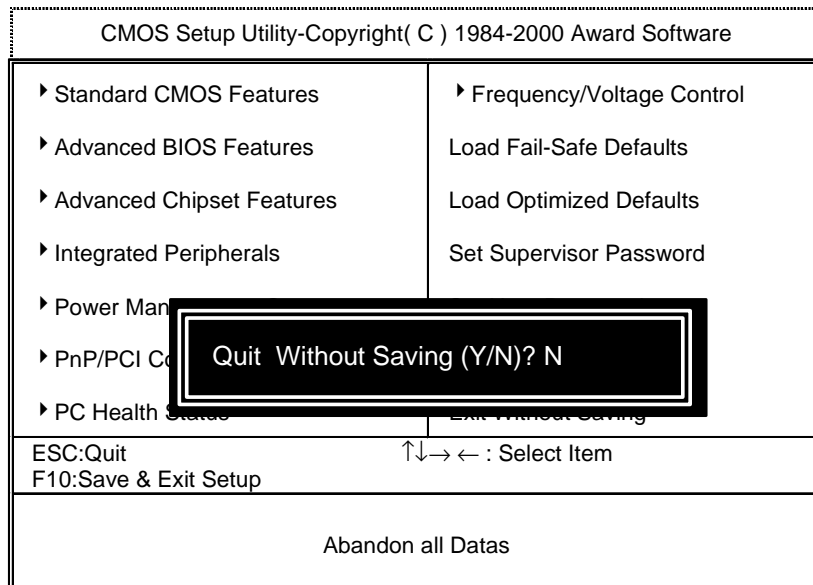

Figure 14: Exit Without Saving

Type "Y" will quit the Setup Utility without saving to RTC CMOS.

Type "N" will return to Setup Utility.

Appendix

Appendix A: AMD 761_VIA 686A/B Chipsets Driver Installation

A.AMD AGP Miniport Driver (Win98/SE/ME only):

Insert the support CD that came with your motherboard into your CD-ROM driver or double –click the CD driver icon in My Computer to bring up the screen.



(1)

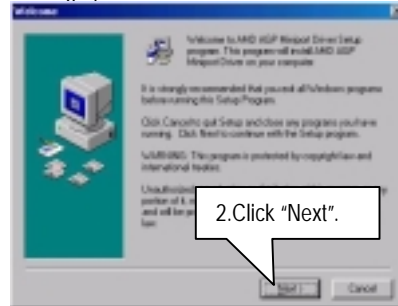

(2)

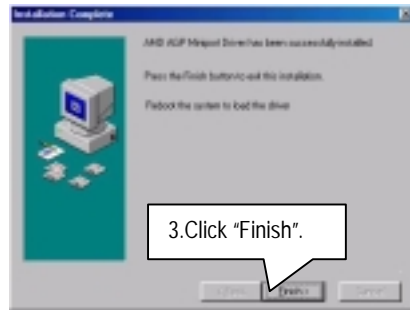

(3)

☛ When the AMD AGP Miniport Driver installation is completed, please restart your computer.

(4)

B: VIA IDE Bus Master Driver Installation

Insert the support CD that came with your motherboard into your CD-ROM drive or double-click the CD drive icon in **My Computer** to bring up the setup screen.

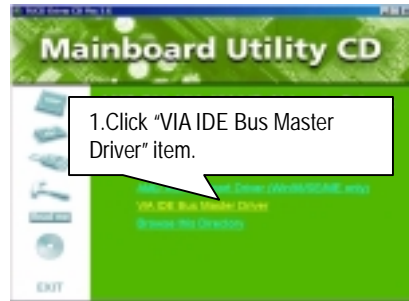

(1)

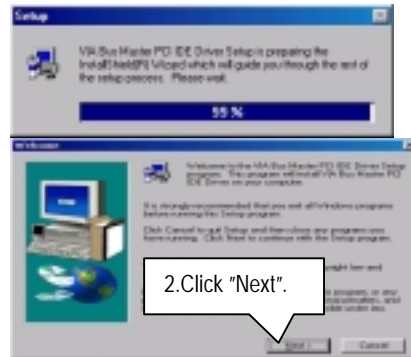

(2)

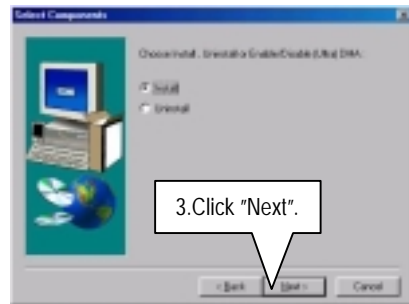

(3)

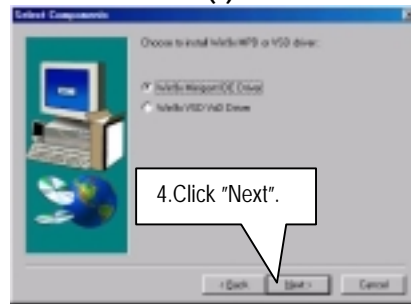

(4)

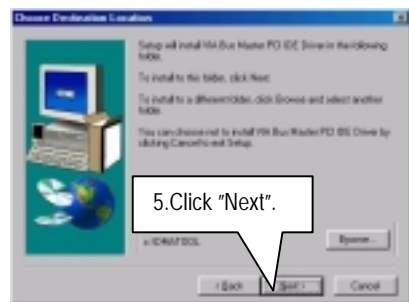

(5)

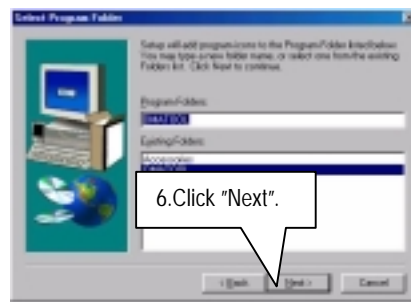

(6)



(7)

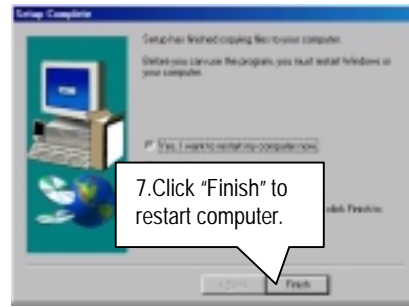

(8)

Appendix B: Creative Sound Driver Installation (Optional)

Insert the support CD that came with your motherboard into your CD-ROM driver or double-click the CD driver icon in My Computer to bring up the screen.

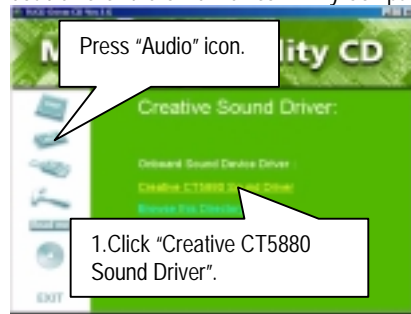

(1)

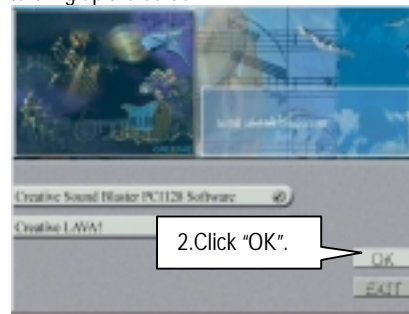

(2)

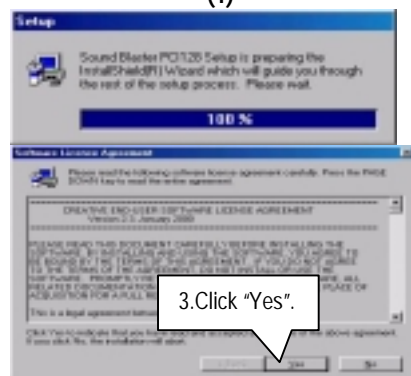

(3)

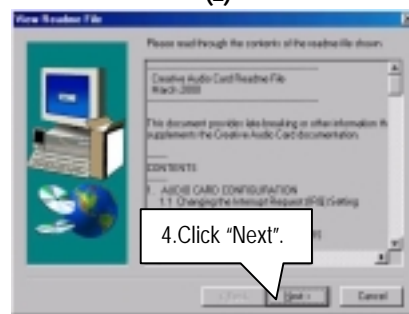

(4)

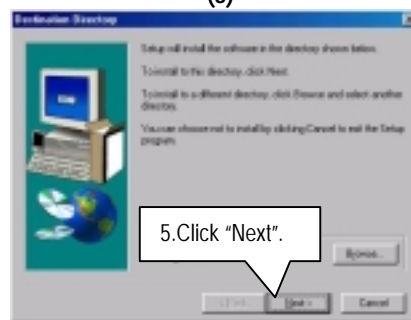

(5)

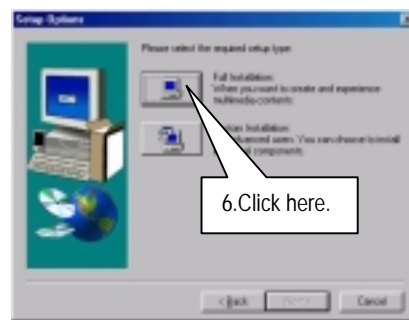

(6)

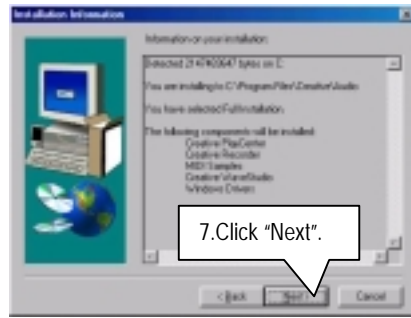

(7)



(8)



(9)

Appendix C: EasyTuneIII Setup

Insert the support CD that came with your motherboard into your CD-ROM driver or double-click the CD driver icon in My Computer to bring up the screen.

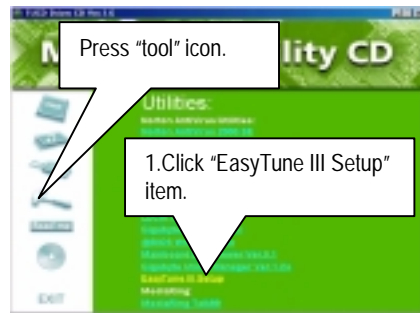

(1)



(2)

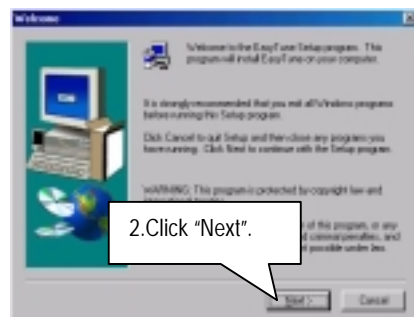

(3)

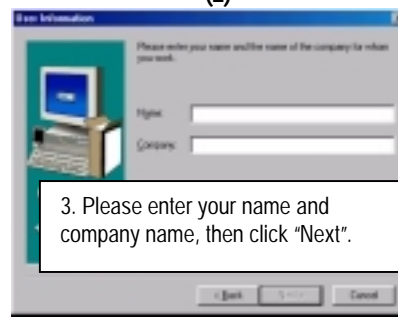

(4)

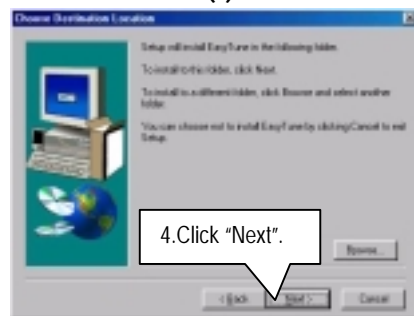

(5)

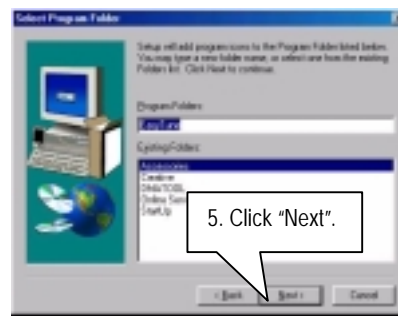

(6)

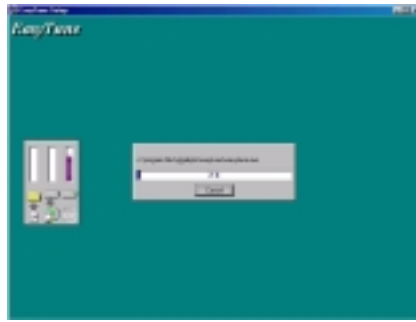

(7)

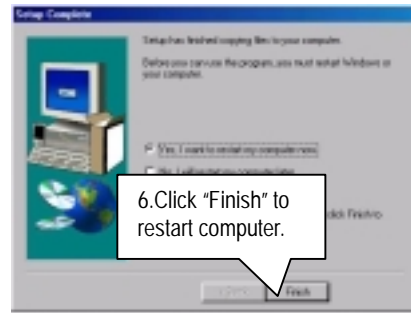

(8)

Appendix D: BIOS Flash Procedure

BIOS update procedure:

If your OS is Win9X, we recommend that you used Gigabyte @BIOS™ Program to flash BIOS.

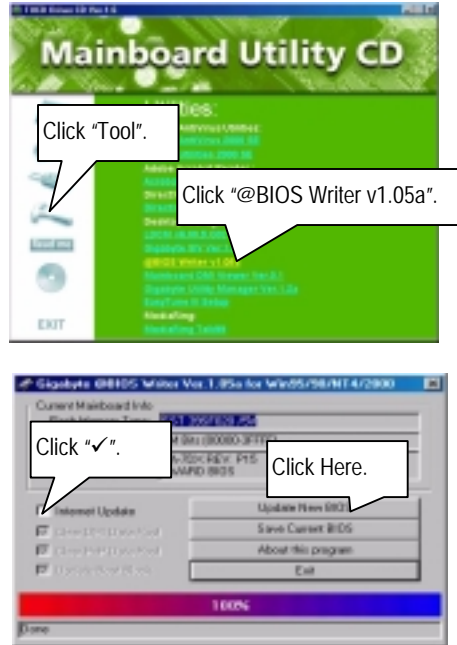

Methods and steps:

I. Update BIOS through Internet

- a. Click "Internet Update" icon
- b. Click "Update New BIOS" icon
- c. Select @BIOS™ sever ("Gigabyte @BIOS™ sever 1 in Taiwan" and "Gigabyte @BIOS™ sever 2 in Taiwan" are available for now, the others will be completed soon)
- d. Select the exact model name on your motherboard
- e. System will automatically download and update the BIOS.

II. Update BIOS **NOT** through Internet:

- a. **Do not** click "Internet Update" icon
- b. Click "Update New BIOS"
- c. Please select "All Files" in dialog box while opening the old file.
- d. Please search for BIOS unzip file, downloading from internet or any other methods (such as: 7DX.F1).
- e. Complete update process following the instruction.

III. Save BIOS

In the very beginning, there is "Save Current BIOS" icon shown in dialog box. It means to save the current BIOS version.

IV. Check out supported motherboard and Flash ROM:

In the very beginning, there is "About this program" icon shown in dialog box. It can help you check out which kind of motherboard and which brand of Flash ROM are supported.

Note:

- a. In method I, if it shows two or more motherboard's model names to be selected, please make sure your motherboard's model name again. Selecting name will cause the system unbooted.
- b. In method II, be sure that motherboard's model name in BIOS unzip file are the same as your motherboard's. Otherwise, your system won't boot.
- c. In method I, if the BIOS file you need cannot be found in @BIOS server, please go onto Gigabyte's web site for downloading and updating it according to method II.
- d. Please note that any interruption during updating will cause system unbooted

Or else you can select flash BIOS in DOS mode.

☛ Please check your **BIOS vendor (AMI or AWARD)**, your **motherboard name** and **PCB version** on the motherboard.

1. Format a bootable system floppy diskette by the command "**format a:/s**" in command mode.
2. Visit the Gigabyte website at [http:// www.gigabyte.com.tw](http://www.gigabyte.com.tw) , Select the BIOS file you need and download it to your bootable floppy diskette.
3. Insert the bootable diskette containing the BIOS file into the floppy diskette driver.
4. Assuming that the floppy diskette driver is A, reboot the system by using the A: driver. At the A: > prompt, run the BIOS upgraded file by executing the Flash BIOS utility and the BIOS file with its appropriate extension.

Example: *(AMI tool) (Where 7dx.f1 is name of the BIOS file name)*

```
A:>flashxxx.exe 7dx.f1 ↵
```

Example: *(Award tool) (Where 7dx.f1 is name of the BIOS file name)*

```
A:>Awdflash.exe 7dx.f1 ↵
```

5. Upon pressing the <Enter> key, a flash memory writer menu will appear on screen. Enter the new BIOS file name with its extension filename into the text box after file name to program.
6. If you want to save the old BIOS file(perform as soon as system is operational, this is recommended), select Y to **DO YOU WANT TO SAVE BIOS**, then type the old BIOS filename and the extension after filename to save: This option allows you to copy the contents of the flash memory chip onto a diskette, giving you a backup copy of the original motherboard BIOS in case you need to re-install it. Select N to **DO YOU WANT TO SAVE BIOS**, if you don't want to save the old BIOS file.
7. After the decision to save the old BIOS file or not is made, select Y to **ARE YOU SURE TO PROGRAM** when the next menu appear; wait until a message showing Power Off or Reset the system appears. Then turn off your system.
8. Remove the diskette and restart your system.
9. Hold down <Delete> key to enter BIOS setup. You must select "Load Setup BIOS Default" to activate the new BIOS, then you may set other item from the main menu.

Appendix E: Acronyms

Acronyms	Meaning
ACPI	Advanced Configuration and Power Interface
APM	Advanced Power Management
AGP	Accelerated Graphics Port
AMR	Audio Modem Riser
ACR	Advanced Communications Riser
BIOS	Basic Input / Output System
CPU	Central Processing Unit
CMOS	Complementary Metal Oxide Semiconductor
CRIMM	Continuity RIMM
CNR	Communication and Networking Riser
DMA	Direct Memory Access
DMI	Desktop Management Interface
DIMM	Dual Inline Memory Module
DRM	Dual Retention Mechanism
DRAM	Dynamic Random Access Memory
DDR	Double Data Rate
ECP	Extended Capabilities Port
ESCD	Extended System Configuration Data
ECC	Error Checking and Correcting
EMC	Electromagnetic Compatibility
EPP	Enhanced Parallel Port
ESD	Electrostatic Discharge
FDD	Floppy Disk Device
FSB	Front Side Bus
HDD	Hard Disk Device
IDE	Integrated Dual Channel Enhanced
IRQ	Interrupt Request
I/O	Input / Output
IOAPIC	Input Output Advanced Programmable Input Controller
ISA	Industry Standard Architecture
LAN	Local Area Network
LBA	Logical Block Addressing
LED	Light Emitting Diode
MHz	Megahertz
MIDI	Musical Interface Digital Interface
MTH	Memory Translator Hub
MPT	Memory Protocol Translator
NIC	Network Interface Card
OS	Operating System

To be continued...

Acronyms	Meaning
OEM	Original Equipment Manufacturer
PAC	PCI A.G.P. Controller
POST	Power-On Self Test
PCI	Peripheral Component Interconnect
RIMM	Rambus in-line Memory Module
SCI	Special Circumstance Instructions
SECC	Single Edge Contact Cartridge
SRAM	Static Random Access Memory
SMP	Symmetric Multi-Processing
SMI	System Management Interrupt
USB	Universal Serial Bus
VID	Voltage ID