



Apollo/Shadowhawk

U S E R M A N U A L





System Manual

Copyright

Premio is a registered trademark of Premio Computer, Inc. All other brands and product names are trademarks or registered trademarks of their respective companies.

© 1997 by Premio Computer, Inc. All rights reserved.

Printed in Taiwan.

Apollo/Shadowhawk, May 2000.

Disclaimers

Premio makes no representation or warranties, either expressed or implied, with respect to the contents of this publication and specifically disclaims the implied warranties of merchantability or fitness for a particular purpose. Premio shall not be liable for technical or editorial errors or omissions in this publication, or for incidental or consequential damages resulting from the furnishing, performance, or use of this publication. We reserve the right to revise this publication and to make changes from time to time in its contents without notification.

Contents

GETTING STARTED	1
Setting Up	2
Switches and Indicators	3
UPGRADING	5
Opening the System Unit	6
Installing an Expansion Card.....	7
Installing a Hard Drive	8
GETTING HELP	9
Troubleshooting	9
Monitor Does Not Work.....	9
Keyboard Does Not Work	10
Mouse Does Not Work.....	10
System Unit Problems	11
Hard Drive Problems.....	11
Technical Support	12
Premio on the Internet	12

APPENDIX..... 13

- Warranty Policy 13**
 - Service Under Warranty..... 14
 - Exclusions from Limited Warranty Programs..... 14
- FCC Standards 15**
- Important Safety Instructions 16**

Getting Started

Your Premio[®] system consists of three components:

- a mid-tower or desktop system unit
- a keyboard
- a mouse

Add your choice of monitor, and your system is ready to use.

Mid-tower system

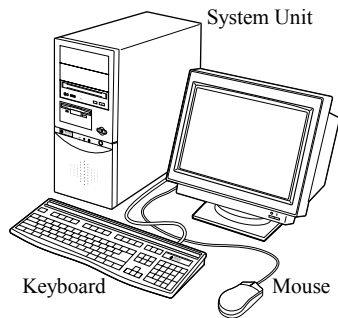

Desktop system

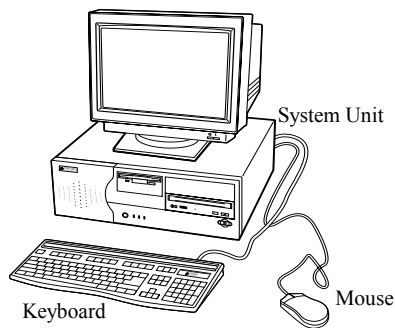

Setting Up

To set up your Premio system, simply connect your monitor, the mouse, the keyboard, and any additional components you want to use to the system unit.

Follow these easy steps:

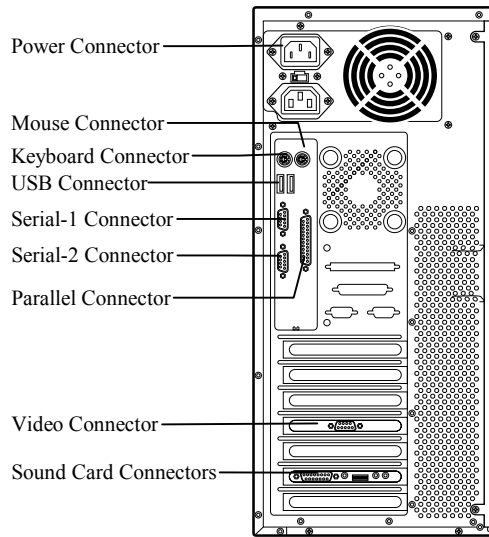

- 1 Attach your monitor's video cable to the video connector.
- 2 Attach the mouse cable to the mouse connector.
- 3 Attach the keyboard cable to the keyboard connector.
- 4 Attach the cables for any additional components, such as a printer, scanner, or modem, to the respective parallel, serial, or universal serial bus (USB) connector, as directed in the component's manual.
- 5 If your system is equipped for multimedia, attach your speakers and microphone to the sound card connectors.
- 6 Plug your monitor's power cord into a power outlet.
- 7 Attach the female end of the system power cord to the system unit's power connector, and then plug the other end of the cord into a power outlet.

Your Premio system is now ready to use. To start the system, turn on your monitor's power switch, and then press the system power switch as shown on the next page.

Switches and Indicators

The system unit's front panel provides access to the CD-ROM and floppy drives, and to the system's switches and indicator lights.

The illustration below shows a mid-tower system. If you have a desktop system, turn to the illustration on the next page.

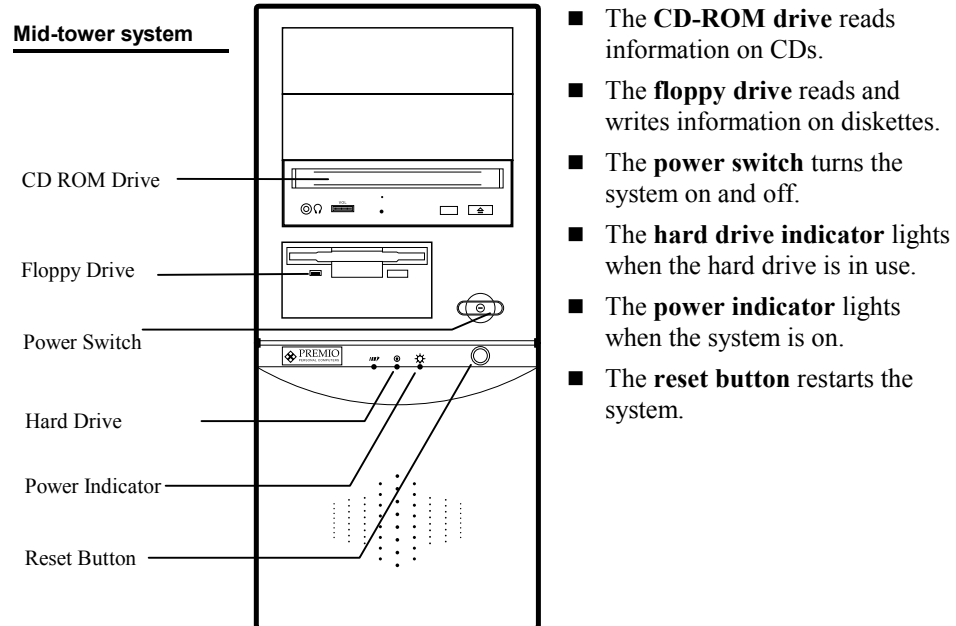

4 Premio System Manual

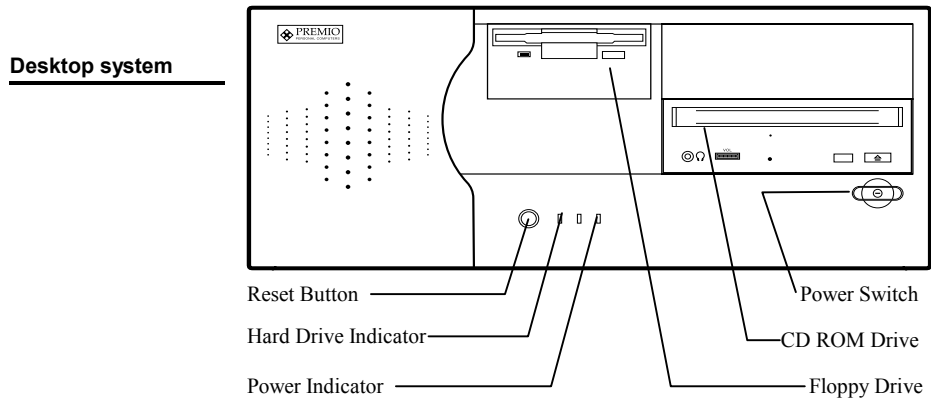

- The **reset button** restarts the system.
- The **hard drive indicator** lights when the hard drive is in use.
- The **power indicator** lights when the system is on.
- The **power switch** turns the system on and off.
- The **CD-ROM drive** reads information on CDs.
- The **floppy drive** reads and writes information on diskettes.

Upgrading

You can upgrade your Premio system with:

- Expansion cards
- More memory
- An additional hard drive

To install an upgrade, you must open the system unit. Before proceeding, read the important cautionary note below. Then follow the steps on the next page.

Caution! *Static discharge can cause permanent damage to internal electronic components of your computer. Always use the following precautions when working inside the system unit:*

- *Wear a grounding wrist strap (available at most electronics stores) when handling electronic components.*
- *Do not remove a component from its antistatic packaging until you are ready to install it.*
- *Keep one hand in contact with the metal system case.*

Opening the System Unit

Note: *Opening the system unit could affect your warranty. Check with the dealer where you purchased your system before opening the system unit.*

To open the system unit, follow these steps:

Mid-tower system

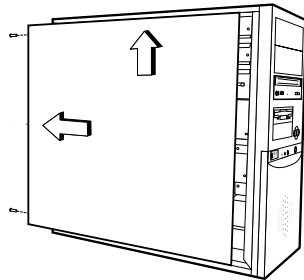

1 Turn off the system and unplug the power cord.

2 Remove the screws securing the side panel (mid-tower) or case (desktop) at the rear of the system unit.

Desktop system

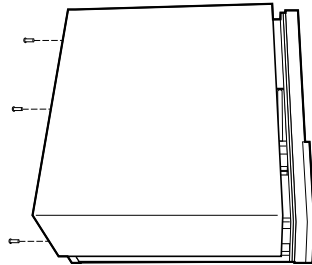

3 Slide the side panel or case up and to the rear, and remove it.

Installing an Expansion Card

To install an expansion card, open the system unit as described on the previous page. Then follow these steps:

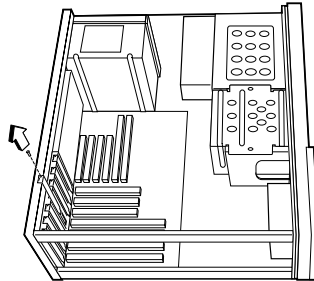

- 1** Remove the screw securing the slot bracket cover for the expansion slot you want to use. Save the screw to secure the expansion card.

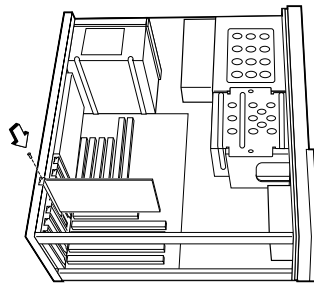

- 2** Insert the expansion card firmly into the slot, making sure it is seated completely.
- 3** Secure the card with the saved screw.

Installing a Hard Drive

To install a hard drive in your system, follow these steps:

- 1 Disconnect the hard drive cable and power connector.

Mid-tower system

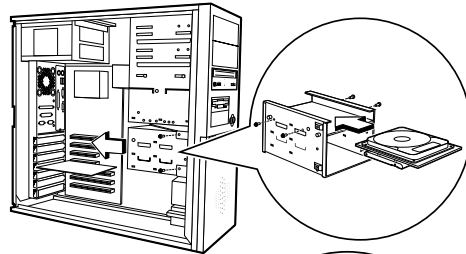

Desktop system

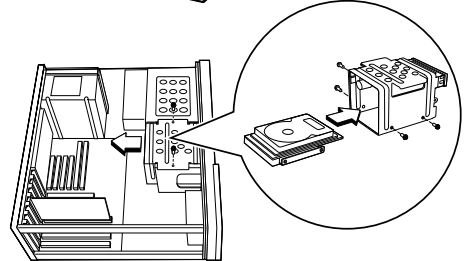

- 2 Remove the two screws securing the drive bay.
- 3 Slide the bay toward the rear of the system unit to remove it.
- 4 Insert the new drive into an open position in the bay and secure it with four screws.
- 5 Slide the bay back into the system unit and secure it with two screws.
- 6 Connect the cables.

Getting Help

Troubleshooting

Your Premio system is designed to provide years of trouble-free performance. If you have a problem with your system, you may wish to check the information in this section for a quick solution.

Monitor Does Not Work

If your monitor appears not to be working properly:

- Check that the monitor's power cable is securely attached to the monitor and to an outlet that is receiving power.
- Check that the monitor's video cable is securely attached to the monitor and to the system unit's video card connector.
- Check that the monitor's power switch is on.
- Adjust the monitor's brightness and contrast controls.
- If possible, substitute another monitor that is in good working order. If the substitute works, your monitor may need repair or replacement.

Keyboard Does Not Work

If the NumLock indicator in the upper right corner of the keyboard does not light when the system powers up, or the keyboard does not work:

- Check that the keyboard cable is securely attached to the system unit's keyboard connector.
- If possible, substitute another keyboard that is in good working order. If the substitute works, your keyboard may need replacement.

Mouse Does Not Work

If your mouse pointer does not move or moves erratically when you move the mouse:

- Check that the mouse cable is securely attached to the mouse connector on the system unit.
- Disassemble the mouse and clean the roller ball.

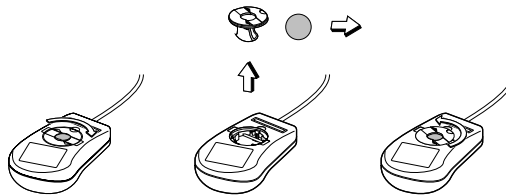

System Unit Problems

The fan inside the system unit should make a low, steady sound when operating properly.

If the fan is totally silent:

- Check that the system power cord is securely attached to the back of the system unit and to a power outlet. Verify that the outlet has power.
- If possible, substitute another power cord that is in good working order. If the substitute works, replace your power cord.

If the fan makes excessive noise:

- Turn off the system, open the system unit case, and inspect the fan for any obstructions.
- Turn on the system and listen closely to the fan. If the noise comes from inside the fan housing, your power supply may need replacement.

Hard Drive Problems

Your hard drive should make a slight whirring sound when operating properly.

If the drive is totally silent:

- Turn off the system, open the system unit case, and check that the power cable between the power supply and the hard drive is securely attached at both ends. If it is, your hard drive may be defective.

If the hard drive makes excessive noise:

- Turn off the system, open the system unit case, and remove the hard drive power cable connector from the hard drive. Then turn the system back on. If the noise disappears, your hard drive may be defective.
- If you have more than one hard drive, repeat the same procedure for each drive.

Technical Support

You can contact Premio technical support at the following address:

Premio Computer, Inc.

918 Radecki Court

City of Industry, CA 91748

Telephone: 626.839.3100

Fax: 626.839.3191

Email: support@premiopc.com

Web page: <http://support.premiopc.com>

Premio on the Internet

Premio maintains a web page on the Internet with the latest information on Premio products, updated drivers, answers to common problems, a troubleshooting guide, and more. Visit our web page at:

<http://www.premiopc.com>

Appendix

Warranty Policy

Premio Computer, Inc. warrants its line of Premio[®] computer systems to be free from defects in material and workmanship for a specific warranted period as stated below, from the date of original purchase from Premio Computer, Inc. or a Premio Computer, Inc. authorized reseller. This warranty is contingent upon proper use of the product in question and does not cover products which have been modified or which have been subjected to unusual physical or electrical stress. Warranty for third party hardware and software, if any, is subject to the third party's warranty policy. Please refer to the following for length of warranty for Premio's product line.

Premio Product	Warranty
Complete Premio System with monitor	3 years parts and labor
Premio Barebone (with or without CPU)	2 years parts and labor
Premio Monitor	2 year parts and labor
Premio OEM Component (motherboard, speaker, case, keyboard, mouse, floppy drive, CD-ROM, etc.)	2 years parts and labor

Service Under Warranty

If this product fails to be in good working order during the warranty period (or specific period of time as noted above), Premio Computer, Inc. will, at its option, repair or replace the product. Repair parts and/or replacement products may be either new or reconditioned at Premio Computer Inc.'s discretion. The limited warranty does not include service or repair for damage from improper installation, abuse or modifications to the product not approved in writing by Premio Computer, Inc. Any service repair outside the scope of this limited warranty will be at Premio Computer, Inc.'s or its Authorized Service Provider's rates and terms in effect. This warranty is valid only within the United States, Puerto Rico, Canada, Mexico and South America.

Exclusions from Limited Warranty Programs

All other expressed and implied warranties for this product are hereby disclaimed. If this product is not in good working order as warranted above, Premio Computer's sole and exclusive remedy shall be repair or replacement as stated above. In no event will Premio Computer, Inc. be liable to the customer or any third party for any damages in excess of the purchase price of the product. This limitation applies to damages of any kind including any direct or indirect damages, lost profits, lost savings or other special, incidental or consequential damages. This holds true for situations even if Premio Computer, Inc. or an authorized Premio representative or dealer has been advised of the possibility of such damages or of any claim by another party. Some states do not allow the exclusion or limitation of incidental or consequential damages for some products, so the above limitation or exclusion may not apply to you. Premio Computer, Inc. authorized resellers and service providers/partners may be changed, added or deleted, without notice or liability. Premio Computer, Inc. disclaims any authorized resellers and service provider/partner to the program. This warranty gives you specific legal rights and you may also have other rights, which may vary from state to state.

FCC Standards

This equipment has been tested and found to comply with the limits for a Class B digital device, pursuant to Part 15 of the FCC Rules. These limits are designed to provide reasonable protection against harmful interference in a residential installation. This equipment generates, uses and can radiate radio frequency energy and, if not installed and used in accordance with the instructions, may cause harmful interference to radio communications. However, there is no guarantee that interference will not occur in a particular installation. If this equipment does cause harmful interference to radio or television reception, which can be determined by turning the equipment off and on, the user is encouraged to try to correct the interference by one or more of the following measures:

- Reorient or relocate the receiving antenna.
- Increase the separation between the equipment and receiver.
- Connect the equipment into an outlet on a circuit different from that to which the receiver is connected.
- Consult the dealer or an experienced radio/TV technician for help.

Important Safety Instructions

These instructions are provided by Underwriters Laboratories, Inc.

1. Read all of these instructions and save them for later reference.
2. Follow all warnings and instructions marked on the product.
3. Unplug this product from the wall outlet before cleaning. Do not use liquid or aerosol cleaners. Use a damp cloth for cleaning.
4. Do not use this product near water.
5. Do not place this product on an unstable cart, stand or table. The product may fall, causing serious damage to the product.
6. Slots and openings on the cabinet and the back or bottom are provided for ventilation. To ensure reliable operation of the product and to protect it from overheating, do not block or cover these openings. The openings should never be blocked by placing the product on a bed, sofa, rug or other similar surface. This product should never be placed near or over a radiator or heat register. This product should not be placed in a built-in installation unless proper ventilation is provided.
7. This product should be operated from the type of power source indicated on the marking label. If you are not sure of the type of power available, consult your dealer or local power company.
8. This product is equipped with a 3-wire grounding-type plug, a plug having a third (grounding) pin. This plug will only fit into a grounding-type power outlet. This is a safety feature. If you are unable to insert the plug into the outlet, contact your electrician to replace your obsolete outlet. Do not defeat the safety purpose of the grounding-type plug.
9. Do not allow anything to rest on the power cord. Do not locate this product where the cord will be walked on.
10. If an extension cord is used with this product, make sure that the total of the ampere ratings on the products plugged into the extension cord do not exceed the extension cord ampere rating. Also, make sure that the total of all products plugged into the wall outlet does not exceed 15 amperes.
11. Never push objects of any kind into this product through cabinet slots as they may touch dangerous voltage points or short out parts

that could result in a risk of fire or electric shock. Never spill liquid of any kind on the product.

12. Except as explained elsewhere in this manual, don't attempt to service this product yourself. Opening and removing those covers that are marked "Do Not Remove" may expose you to dangerous voltage points or other risks. Refer all servicing on those compartments to service personnel.
13. Unplug this product from the wall outlet and refer servicing to qualified service personnel under the following conditions:
 - A. When the power cord or plug is damaged or frayed.
 - B. If liquid has been spilled into the product.
 - C. If the product has been exposed to rain or water.
 - D. If the product does not operate normally when the operating instructions are followed. Adjust only those controls that are covered by the operating instructions since improper adjustment of other controls may result in damage and will often require extensive work by a qualified technician to restore the product to normal operation.
 - E. If the product has been dropped or the cabinet has been damaged.
 - F. If the product exhibits a distinct change in performance, indicating a need for service.

Chapter 1

INTRODUCTION

The MS-6339 ATX TH1 mainboard is a high-performance computer mainboard based on Intel® 82850 chipset. The MS-6339 is optimized to support the Intel® Pentium® 4 processor for high-end business/personal desktop markets.

The Intel® Tehama chipset supports 64B cache line size and a 32-bit host addressing, allowing the processor to access the entire 4GB of the chipset's memory address space. It also provides 4x AGP data transfers and 2x/4x AGP Fast Writes capability. Including a 3.2GBs memory bus bandwidth and 3.2GBs system bus bandwidth.

The Intel® Tehama chipset features a dual channel Direct RDRAM memory operating in lock-step using RSL technology. It is a highly-flexible chipset which is designed to extend the basic graphics/multimedia PC platform up to the mainstream performance desktop platform.

The Intel® 82801BA (ICH2) chipset is a highly integrated multifunctional I/O Controller Hub that provides the interface to the PCI Bus and integrates many of the functions needed in today's PC platforms. It communicates with the host controller over a dedicated hub interface and provides added flexibility in designing cost-effective system solutions.

Mainboard Features

CPU

- Support Intel® Pentium® 4 processor
- Supports 1.4GHz or faster

Chipset

- Intel® Tehama chipset
 - Up to 2GB maximum memory (RAMBUS).
 - AGP Pro interface with 4x SBA/Data Transfer
- Intel® ICH2 chipset
 - AC'97 Controller Integrated
 - 2 Full IDE channels, up to ATA100
 - Low pin count interface for SIO
 - 4 USB Ports

Main Memory

- Supports four 168-pin gold-lead RIMM sockets
- Supports a maximum memory size of 2GB

Slots

- One AGP (Accelerated Graphics Port) Pro slot
 - support up to 4x mode
- One CNR (Communication Network Riser) slot
- Five 32-bit/33MHz Master PCI Bus slots
- Supports 3.3v/5v PCI bus Interface

On-Board IDE

- An IDE controller on the Intel® ICH2 Chipset provides IDE HDD/CD-ROM with PIO, Bus Master and Ultra DMA 100 operation modes
- Can connect up to four IDE devices

Integrated Super I/O Controller

- Winbond W83627HF-AW I/O controller
 - 1 floppy port supports 2 FDD with 360K, 720K, 1.2M, 1.44M and 2.88Mbytes
 - 2 serial port (COM A + COM B)
 - 1 parallel port supports SPP/EPP/ECP mode
 - 1 IrDA connector for SIR

Audio

- ICH2 chip integrated
- Creative CT5880 (optional)
 - 64 Voice WaveTable Synthesizer
 - Sound Library of over 4000 different sounds
 - Support SPDIF (AC3)
 - Support Microsoft Direct Sound, Direct Sound 3D, Direct Music, and A3DAPI

BIOS

- The mainboard BIOS provides “Plug & Play” BIOS which detects the peripheral devices and expansion cards of the board automatically.
- IDE drive auto configure, Advanced Power Management (APM) 1.2, ACPI 1.0, DMI 2.0, ECC/Parity support.

Dimension

- ATX Form Factor : 12inches(L) x 9.6inches(W) x 6 layers PCB

Mounting

- 12 mounting holes

Mainboard Layout

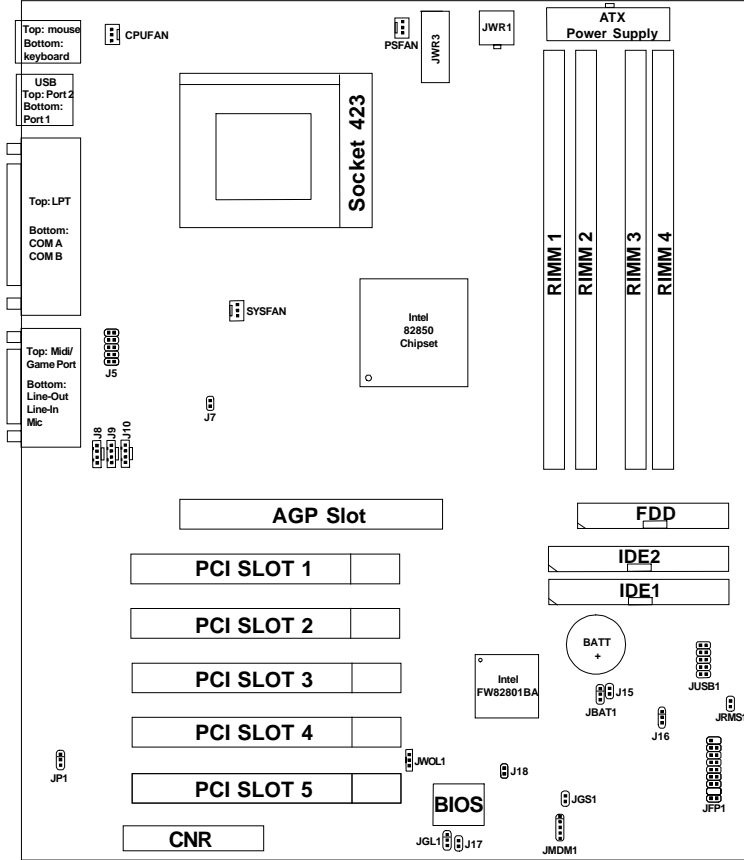

MS-6339 ATX TH1 Mainboard

Chapter 2

HARDWARE INSTALLATION

Central Processing Unit: CPU

The mainboard operates with **Intel® Pentium® 4 processor**. The mainboard uses a CPU socket called Socket 423 for easy CPU installation. The CPU should always have a Heat Sink and a cooling fan attached to prevent overheating.

• CPU Installation Procedures

1. Pull the lever sideways away from the socket. Then, raise the lever up to a 90-degree angle.
2. Locate Pin 1 in the socket and look for the white dot or cut edge in the CPU. Match Pin 1 with the white dot/cut edge. Then, insert the CPU. It should insert easily.
3. Press the lever down to complete the installation.

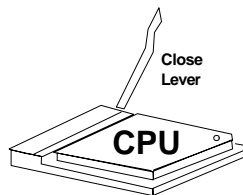
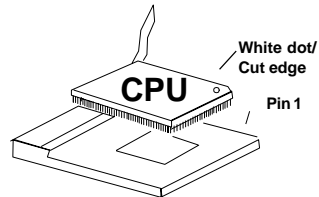
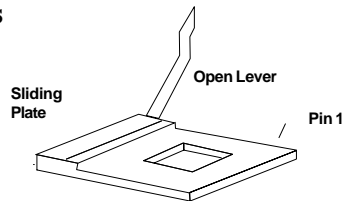

- **Fan Power Connectors: CPUFAN/PSEFAN/SYSFAN**

These connectors support system cooling fan with +12V. It supports three pin head connector. When connecting the wire to the connector, always take note that the red wire is the positive and should be connected to the +12V, the black wire is Ground and should be connected to GND. If your mainboard has System Hardware Monitor chipset on-board, you must use a specially designed fan with speed sensor to take advantage of this function.

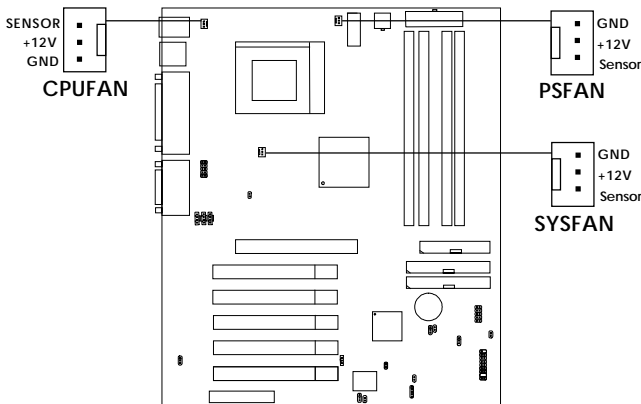

CPUFAN: Processor Fan
PSFAN: Power Supply Fan
SYSFAN: System Fan

For fans with fan speed sensor, every rotation of the fan will send out 2 pulses. System Hardware Monitor will count and report the fan rotation speed.

Note: Always consult vendor for proper CPU cooling fan.

Clear CMOS Jumper: JBAT1

A battery must be used to retain the mainboard configuration in CMOS RAM. Short 1-2 pins of JBAT1 to store the CMOS data.

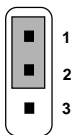
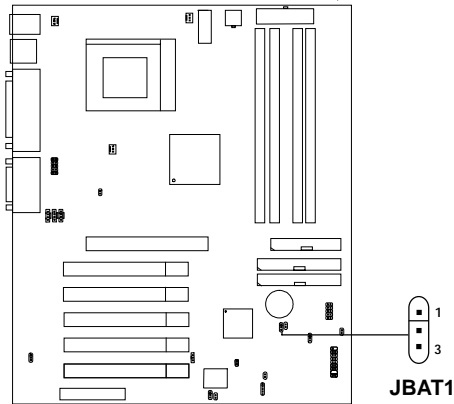

Keep Data

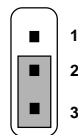

Clear Data

Note: You can clear CMOS by shorting 2-3 pin, while the system is off. Then, return to 1-2 pin position. Avoid clearing the CMOS while the system is on, it will damage the mainboard. Always unplug the power cord from the wall socket.

Memory Installation

- **Memory Bank Configuration**

The mainboard supports a maximum memory size of 2G. It provides four 168-pin RIMMs sockets. It supports 64 MB to 512 Mbytes RIMM memory module.

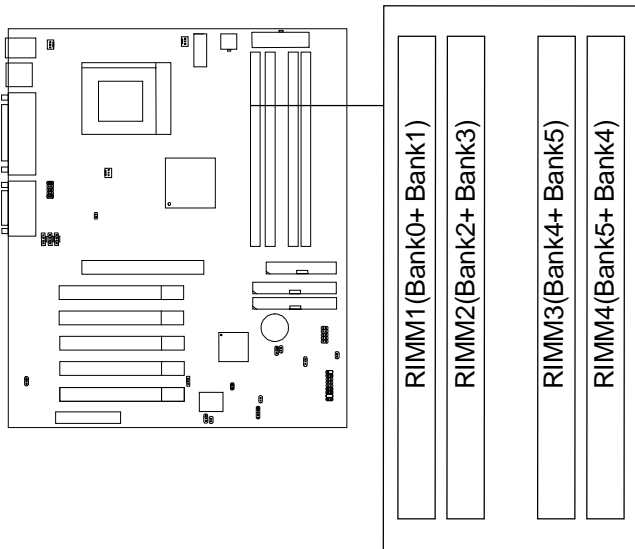

- **Memory Installation Procedures**

- A. How to install a RIMM Module**



1. The RIMM slot has 2 Notch Keys, so the RIMM memory module can only fit in one direction.
2. Insert the RIMM memory module vertically into the RIMM slot. Then push it in.

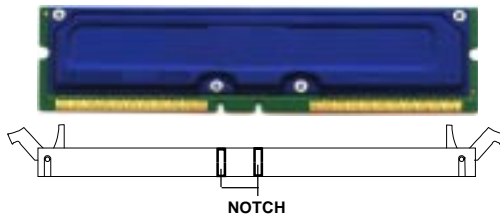

3. The plastic clip at the side of the RIMM slot will automatically close.

• Memory Population Rules

1. Support only RIMM.
2. To operate properly, at least two same size 168-pin RIMM module must be installed.



3. Support FSB 100MHz: 300/400MHz RIMM
4. Support up to 32 Direct Rambus Device.
5. Support ECC Single bit Correction and Multiple bit error detection (Setting in BIOS)

Case Connector: JFP1

The Power Switch, Reset Switch, Power LED, Speaker, HDD LED and Keylock (reserved) are all connected to the JFP1 connector block.

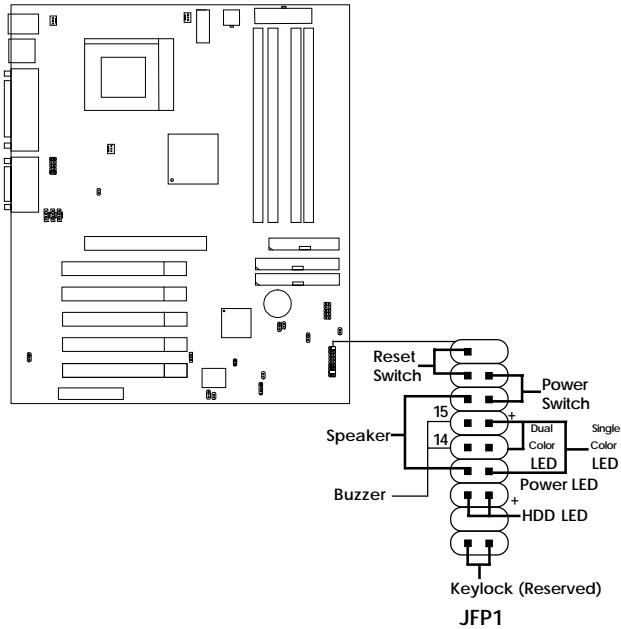

Power Switch

Connect to a 2-pin push button switch. This switch has the same feature with JRMS1.

Reset Switch

Reset switch is used to reboot the system rather than turning the power ON/OFF. Avoid rebooting while the HDD LED is lit. You can connect the Reset switch from the system case to this pin.

Power LED

The Power LED is lit while the system power is on. Connect the Power LED from the system case to this pin. There are two types of LED that you can use: 3-pin single color LED or 2-pin dual color LED (ACPI request).

- a. 3 pin single color LED connect to pin 4, 5, & 6. This LED will lit when the system is on.
- b. 2 pin dual color LED connect to pin 5 & 6.
 - GREEN**Color: Indicate the system is in full on mode.
 - ORANGE**Color: Indicate the system is in suspend mode.

Speaker

Speaker from the system case is connected to this pin.

If on-board Buzzer is available:

Short pin 14-15: On-board Buzzer Enabled.

Open pin 14-15: On-board Buzzer Disabled.

HDD LED

HDD LED shows the activity of a hard disk drive. Avoid turning the power off while the HDD led is lit. You can connect the HDD LED from the system case to this pin.

Keylock (reserved)

Keylock allows you to disable the keyboard for security purposes. You can connect the keylock to this pin.

Floppy Disk Connector: FDD

The mainboard also provides a standard floppy disk connector FDD that supports 360K, 720K, 1.2M, 1.44M and 2.88M floppy disk types. This connector supports the provided floppy drive ribbon cables.



Hard Disk Connectors: IDE1 & IDE2

The mainboard has a 32-bit Enhanced PCI IDE and Ultra DMA/66 Controller that provides PIO mode 0~4, Bus Master, and Ultra DMA/33/66 function. It has two HDD connectors IDE1 (primary) and IDE2 (secondary). You can connect up to four hard disk drives, CD-ROM, 120MB Floppy (reserved for future BIOS) and other devices to IDE1 and IDE2. These connectors support the provided IDE hard disk cable.

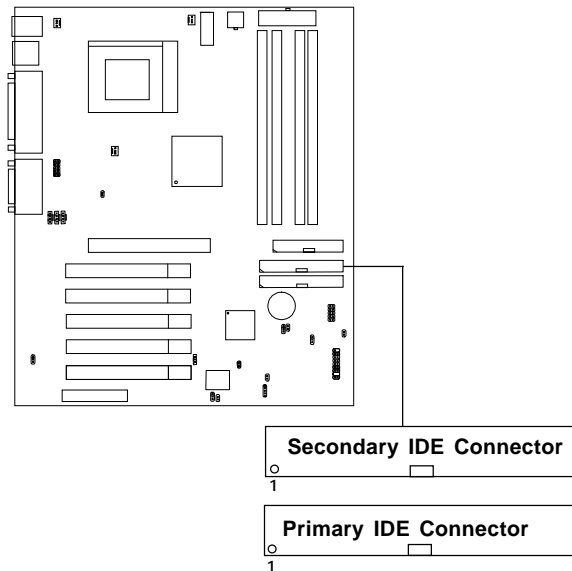

IDE1(Primary IDE Connector)

The first hard drive should always be connected to IDE1. IDE1 can connect a Master and a Slave drive. You must configure second hard drive to Slave mode by setting the jumper accordingly.

IDE2 (Secondary IDE Connector)

IDE2 can also connect a Master and a Slave drive.

Power Supply

- **ATX 20-pin Power Connector: JWR2**
ATX 12V Power Connector: JWR1

These connectors support the power button on-board. Using the ATX power supply, functions such as Modem Ring Wake-Up and Soft Power Off are supported by this mainboard. These power wake connectors support instant power on function which means that system will boot up instantly when the power connector is inserted on the board. Refer to chapter 2-14 for pin definition.

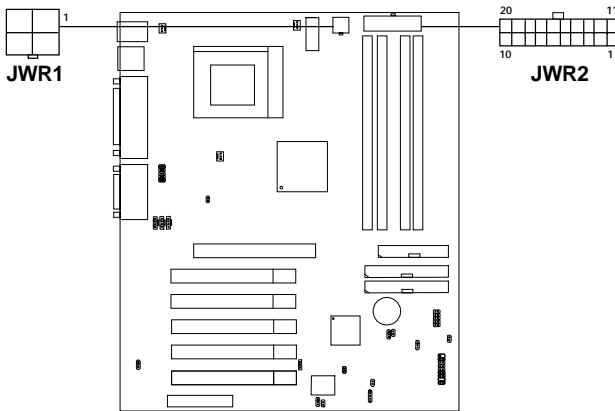

- **ATX 5V/3V Power Connector: JWR3 (optional)**

This mainboard supports an optional 5V/3V power supply connector. Refer to chapter 2-14 for pin definition.

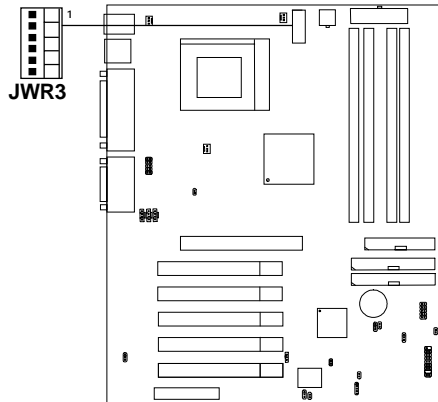

PIN DEFINITION TABLE

Pin definition for JWR2

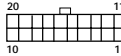

PIN	SIGNAL	PIN	SIGNAL
1	3.3V	11	3.3V
2	3.3V	12	-12V
3	GND	13	GND
4	5V	14	PS_ON
5	GND	15	GND
6	5V	16	GND
7	GND	17	GND
8	PW_OK	18	-5V
9	5V_SB	19	+5V
10	12V	20	+5V

Pin definition for JWR1



PIN	SIGNAL
1	GND
2	GND
3	12V
4	12V

Pin definition for JWR3



PIN	SIGNAL	PIN	SIGNAL
1	GND	4	3.3V
2	GND	5	3.3V
3	GND	6	5V

Warning: Since the mainboard has the instant power on function, make sure that all components are installed properly before inserting the power connector to ensure that no damage will be done.

- **Remote Power On/Off Switch: JRMS1**

Connect to a 2-pin push button switch. During OFF state, press once and the system turns on. **During ON stage, push once and the system goes to sleep mode: pushing it more than 4 seconds will change its status from ON to OFF.** If you want to change the setup, you could go to the BIOS Power Management Setup. This is only used for ATX type power supply.

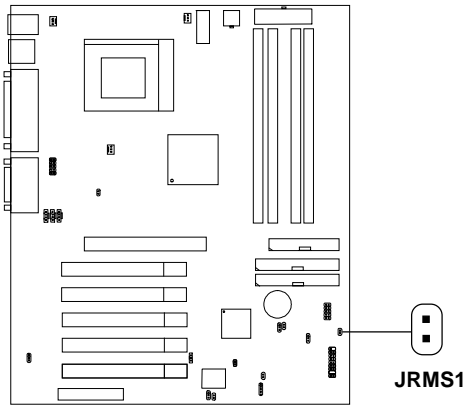

IrDA Infrared Module Connector: J5

The mainboard provides one infrared (IR) connector for IR modules. This connector is for optional wireless transmitting and receiving infrared module. You must configure the setting through the BIOS setup to use the IR function.

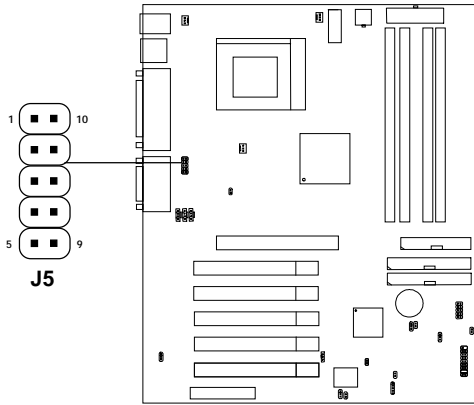

Pin	Signal	Pin	Signal
1	VCC	6	NC
2	NC	7	NC
3	IRRX	8	5VSB
4	GND	9	CIRRX
5	IRTX	10	NC

Serial Port Connectors: COM A and COM B

The mainboard provides two 9-pin male DIN connectors for serial port COM A & COM B. These port are 16550A high speed communication port that send/receive 16 bytes FIFOs. You can attach a mouse or a modem cable directly into this connector.

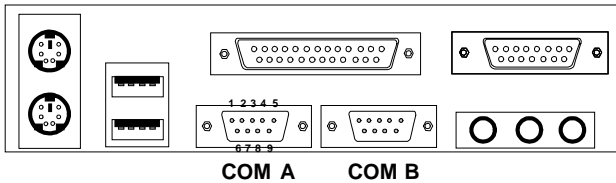

Serial Port (9-pin Male)

PIN DEFINITION

PIN	SIGNAL
1	DCD (Data Carry Detect)
2	SIN (Serial In or Receive Data)
3	SOUT (Serial Out or Transmit Data)
4	DTR (Data Terminal Ready)
5	GND
6	DSR (Data Set Ready)
7	RTS (Request To Send)
8	CTS (Clear To Send)
9	RI (Ring Indicate)

Parallel Port Connector: LPT1

The mainboard provides a 25 pin female centronic connector for LPT. A parallel port is a standard printer port that also supports Enhanced Parallel Port (EPP) and Extended capabilities Parallel Port (ECP). See connector and pin definition below:

Parallel Port (25-pin Female)

LPT 1

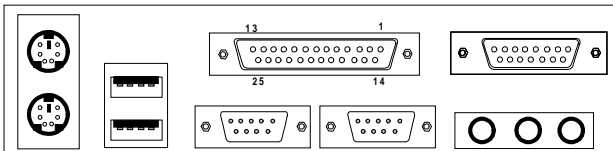

PIN DEFINITION

PIN	SIGNAL	PIN	SIGNAL
1	STROBE	14	AUTO FEED#
2	DATA0	15	ERR#
3	DATA1	16	INIT#
4	DATA2	17	SLIN#
5	DATA3	18	GND
6	DATA4	19	GND
7	DATA5	20	GND
8	DATA6	21	GND
9	DATA7	22	GND
10	ACK#	23	GND
11	BUSY	24	GND
12	PE	25	GND
13	SELECT		

Mouse Connector: JKBMS1

The mainboard provides a standard PS/2[®] mouse mini DIN connector for attaching a PS/2[®] mouse. You can plug a PS/2[®] mouse directly into this connector. The connector location and pin definition are shown below:

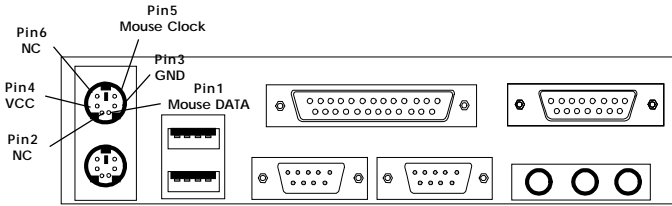

PS/2 Mouse (6-pin Female)

Keyboard Connector: JKBMS1

The mainboard provides a standard PS/2[®] keyboard mini DIN connector for attaching a keyboard. You can plug a keyboard cable directly to this connector.

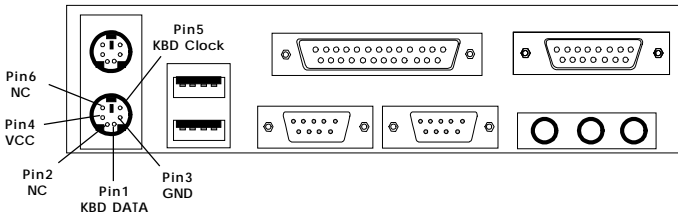

PS/2 Keyboard (6-pin Female)

Joystick/Midi Connectors

You can connect a joystick or game pad to this connector.

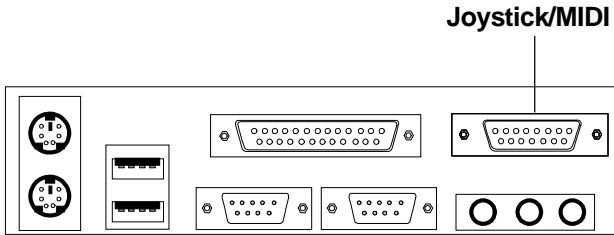

Audio Port Connectors

Line Out is a connector for Speakers or Headphones. **Line In** is used for external CD player, Tape player, or other audio devices. **Mic** is a connector for the microphones.

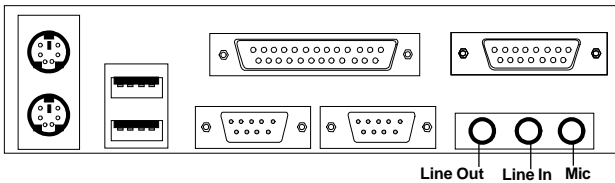

1/8" Stereo Audio Connectors

USB Connectors

The mainboard provides a **UHCI (Universal Host Controller Interface) Universal Serial Bus root** for attaching USB devices like: keyboard, mouse and other USB devices. You can plug the USB device directly to this connector.

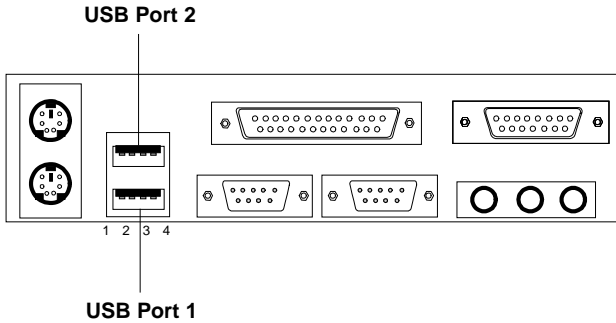

PIN	SIGNAL
1	VCC
2	-Data
3	+Data
4	GND

Wake-Up on LAN Connector: JWOL1

The JWOL1 connector is for used with LAN add-on cards that supports Wake Up on LAN function. To use this function, set the “Wake-Up on LAN” to enable at the BIOS Power Management Setup.

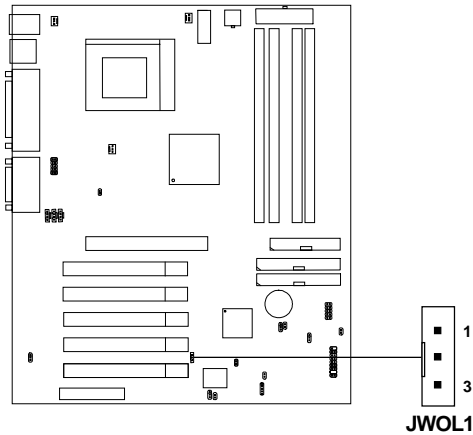

PIN	SIGNAL
1	5VSB
2	GND
3	MP_WAKEUP

Note: LAN wake-up signal is active “high”.

Note: To be able to use this function, you need a power supply that provide enough power for this feature. (Power supply with 750mA 5V Stand-by)

Modem Wake Up Connector: JMDM1

The JMDM1 connector is for used with Modem add-on card that supports the Modem Wake Up function.

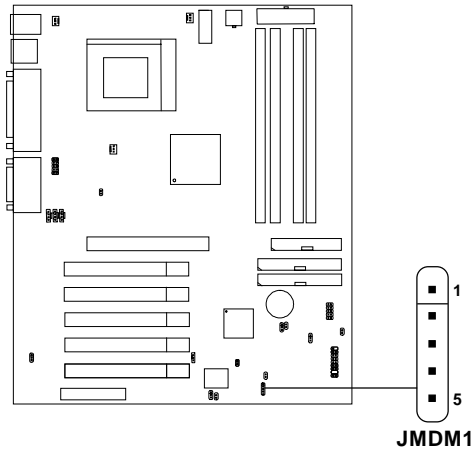

PIN	SIGNAL
1	NC
2	GND
3	MDM_WAKEUP
4	NC
5	5VSB

Note: Modem wake-up signal is active “low”.

Note: To be able to use this function, you need a power supply that provide enough power for this feature. (Power supply with 750mA 5V Stand-by)

Power Saving LED Connector: JGL1

JGL1 can be connected with two-color LED. There are two types of LED that you can use: 3-pin LED or 2-pin LED (ACPI request). When the 2-pin LED is connected to JGL1, the light will turn green, when system is On. During sleep mode, the 2-pin LED will change color from Green to Orange. For 3-pin LED, when LED is connected to JGL1, this will light when the system is On and blinks when it is in suspend/sleep mode.

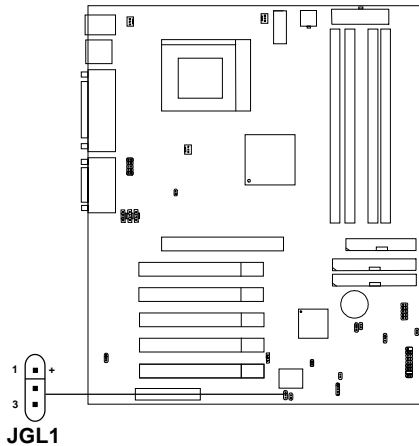

3-pin LED	2-pin LED
<p>1-2 Single Color 1-3 Blink</p>	<p>1-2 Dual Color</p>

Power Saving Switch Connector: JGS1

Attach a power saving switch to **JGS1**. When the switch is pressed, the system immediately goes into suspend mode. Press any key and the system wakes up.

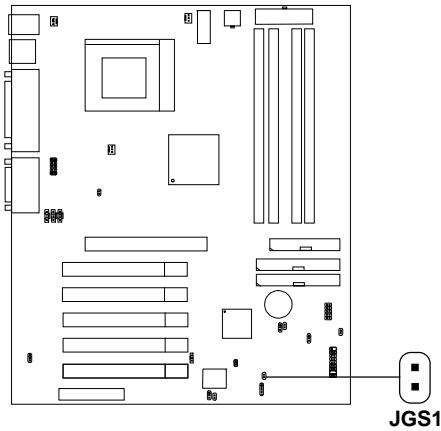

CD-In Connector: J8

This connector is for CD-ROM audio connector.

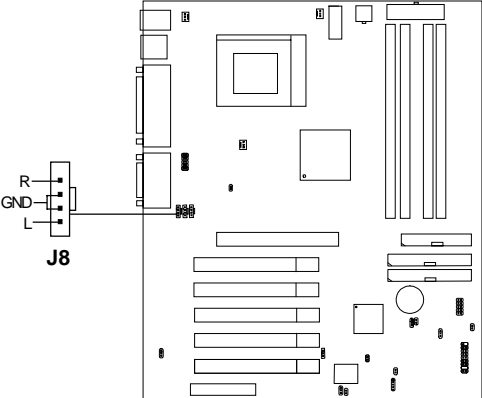

AUX Line In Connector: J9

This connector is used for DVD Add on Card with Line In connector.

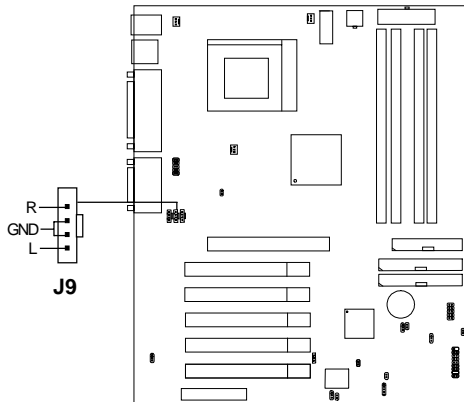

Modem-In: J10

The connector is for Modem with internal voice connector.

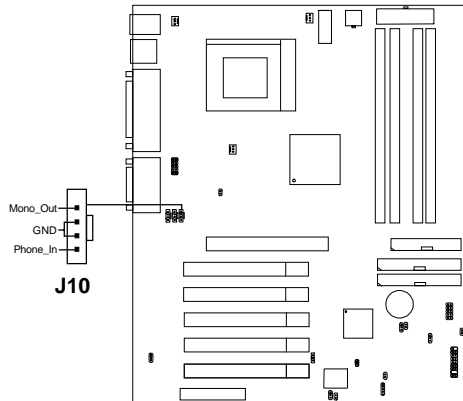

Mono_Out is connected to the Modem Speaker Out connector.

Phone_In is connected to the Modem Microphone In connector.

Onboard Audio Codec: JP1

This jumper is used to Enabled/Disabled the onboard Soft audio codec.

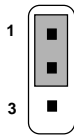
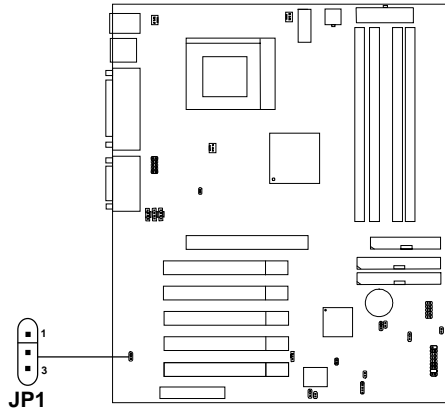

**Enable Onboard
Audio Codec**

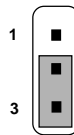

**Disable Onboard
Audio Codec**

Chassis Intrusion Switch Case: J7 & J15

These connectors are connected to 2-pin connector chassis switch. If the Chassis is open, the switch will be short. The system will record this status. To clear the warning, you must enter the BIOS setting and clear the status.

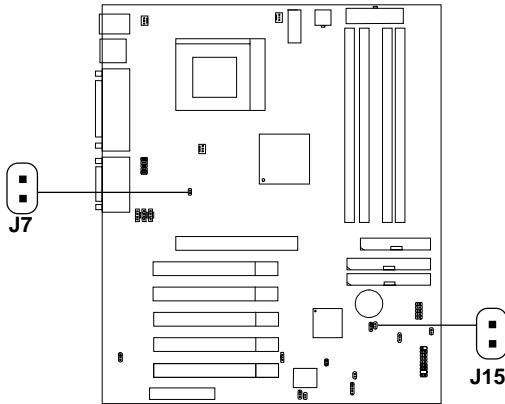

Clear BIOS Password: J18

This is used to clear the BIOS password. To clear the password, open pin and restart your computer.

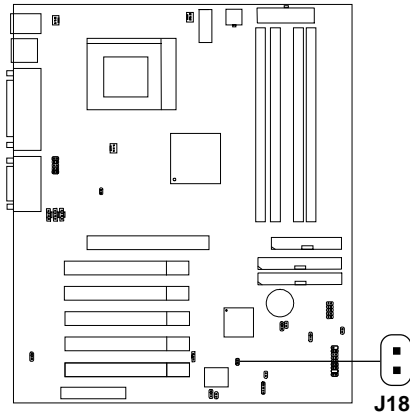

Normal



Clear

BIOS Flash Jumper: J17

This jumper is used to lock/unlock BIOS Flash. This jumper should be unlocked when flashing/programming the BIOS.

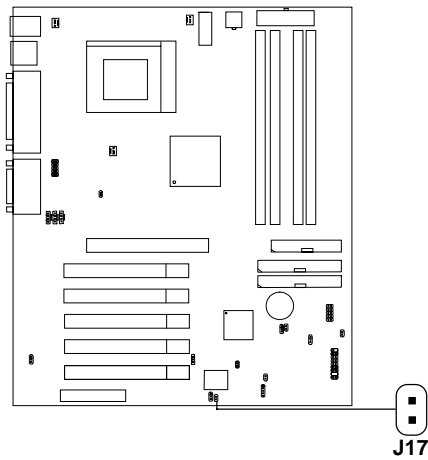

**BIOS Flash
Locked**



**BIOS Flash
Unlocked**

Case Speaker to Audio Speaker Jumper: J16

This jumper will enable the case speaker/buzzer to be transferred to the Audio speaker.

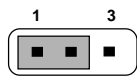
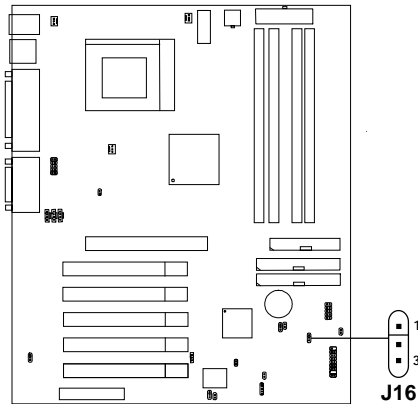

**Output to
Audio Speaker**

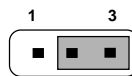

**Output to
Onboard Buzzer
(Default)**

USB Front Connector: JUSB1

The mainboard provides a **front Universal Serial Bus connector**. This is an optional USB connector for Front Panel.

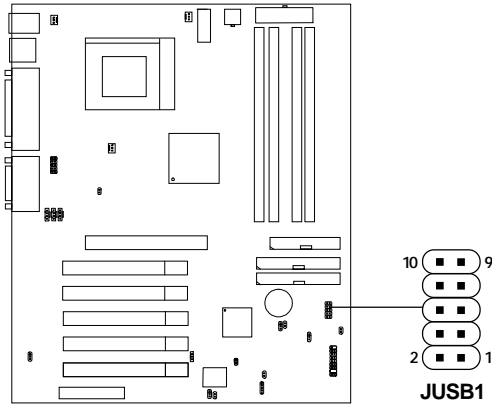

Pin	Description	Pin	Description
1	VCC	6	USB2+
2	GND	7	GND
3	USB3-	8	USB2-
4	GND	9	GND
5	USB3+	10	VCC

CNR (Communication Network Riser)

The Communication Network Riser specification is an open industry-standard specification that defines a hardware scalable Original Equipment Manufacturer (OEM) mainboard riser board and interface, which supports modem, audio and LAN.

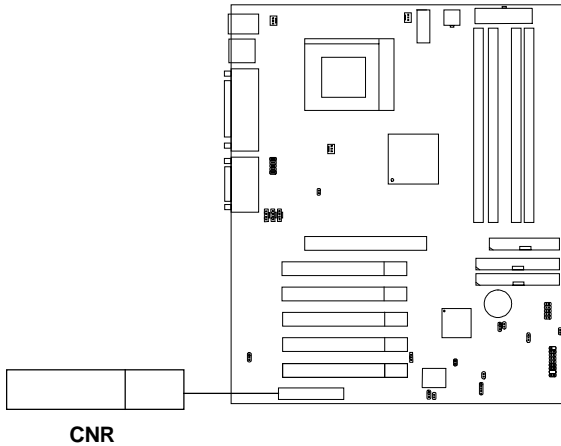

Chapter 3

AMI® BIOS USER'S GUIDE

The system configuration information and chipset register information is stored in the CMOS RAM. This information is retained by a battery when the power is off. Enter the BIOS setup (if needed) to modify this information.

The following pages will describe how to enter BIOS setup, and all about options.

Enter BIOS Setup

Enter the AMI® setup Program's Main Menu as follows:

1. Turn on or reboot the system. The following screen appears with a series of diagnostic check.

```
AMIBIOS (C) 1999 American Megatrends Inc.  
AGIOMS VXXX XXXXXX
```

```
Hit <DEL> if you want to run setup
```

```
(C) American Megatrends Inc.  
61-XXXX-001169-00111111-071592-i82440FX-H
```

2. When the "Hit " message appears, press key to enter the BIOS setup screen.
3. After pressing key, the BIOS setup screen will appear.

Note: *If you don't want to modify CMOS original setting, then don't press any key during the system boot.*

Standard CMOS Setup

1. Press <ENTER> on "Standard CMOS Setup" of the main menu screen .

AMIBIOS SETUP - STANDARD CMOS SETUP							
(C)1999 American Megatrends, Inc. All Rights Reserved							
Date (mm/dd/yyyy): Thu Oct 26, 2000							
Time (hh/mm/ss): 19:22:43							
TYPE	SIZE	CYLS	HEAD	PRECOMP	LANDZ	SECTOR	MODE

Pri Master : Auto							
Pri Slave : Auto							
Sec Master : Auto							
Sec Slave : Auto							
Floppy Drive A: 1.44MB 3 1/2				Base Memory : 640 Kb			
Floppy Drive B: Not Installed				Other Memory: 384 Kb			
				Extended Memory: 511 Mb			
				Total Memory: 512 Mb			
Boot Sector Virus Protection Disabled							
Detecting drive parameters:				ESC:Exit			
Press ESC to Abort				↑↓:Select Item			
				PU/PD/+/- : Modify			
				(Shift) F2: Color			

2. Use <Up> and <Down> to choose the item and <PgUp> and <PgDn> keys to modify the highlighted item.
3. After you have finished with the Standard CMOS Setup, press <ESC> to go back to the main menu.

BIOS Features Setup

1. Press <ENTER> on “BIOS Features Setup” of the main menu screen.

AMIBIOS SETUP - BIOS FEATURES SETUP	
(C) 1999 American Megatrends, Inc. All Rights Reserved	
Quick Boot	:Enabled
1st Boot Device	:Floppy
2nd Boot Device	:IDE-0
3rd Boot Device	:CD-ROM
Try Other Boot Devices	:Yes
BootUp Num-Lock	:On
Floppy Drive Swap	:Disabled
Floppy Drive Seek	:Disabled
Password Check	:Setup
L1 Cache	:WriteBack
Cache Bus ECC	:Disabled
Video BIOS Cacheable	:Disabled
ESC:Quit ↑↓←→:Select Item F1 :Help PU/PD/+/- : Modify F5 :Old Values (Shift)F2: Color F6 :Load BIOS Defaults F7 :Load Setup Defaults	

2. Use <Up> and <Down> to choose the item and <PgUp> and <PgDn> keys to modify the highlighted item.
3. After you have finished with the BIOS Features Setup, press <ESC> to go back to the main menu.

Description of the item on screen follows:

Quick Boot

Set this option to Enabled to permit AMI® BIOS to boot within 5 seconds. This option replaces the old ABOVE 1 MB Memory Test option.

1st Boot Device/2nd Boot Device/3rd Boot Device

This option sets the sequence of boot drives.

The settings are:

IDE0	The system will boot from the first HDD.
IDE1	The system will boot from the Second HDD.
IDE2	The system will boot from the Third HDD.
IDE3	The system will boot from the Fourth HDD.
Floppy	The system will boot from Floppy.
SCSI	The system will boot from the SCSI.
Network	The system will boot from the Network drive.
CD-ROM	The system will boot from the CD-ROM.
ZIP A:/LS120	The system will boot from ZIP/LS120.
ATAPI ZIP C:	The system will boot from ZIP.
Disable	Disable this sequence.

Try other Boot Devices

This option sets the device boot, if all the Four Boot Devices failed.

Boot up Num Lock

When this option is set to Off, AMI® BIOS turns off the Num Lock key when the system is powered on. The end user can then use the arrow keys on both the numeric keypad and the keyboard. The settings are On or Off. The setup default and BIOS settings are On.

Floppy Drive Swap

Set this option to Enabled to specify that floppy drives A: and B: are swapped. The setting are Enabled and Disabled. The setup and BIOS default settings are Disabled.

Floppy Drive Seek

When this option is set to Enabled, AMI® BIOS performs a Seek command on floppy drive A: before booting the system. The settings are Enabled and Disabled. The setup and BIOS default settings are Disabled.

Password Check

This option specifies the type of AMI® BIOS password protection that is implemented. The default settings is Setup.

L1 Cache

Choosing Write Back allows it to write back the level 1 cache memory. The settings are Write Back or Write through or Disabled.

Cache Bus ECC

This option is for Pentium® 4 processor. During Enabled, this will affect the system performance. Disabled this option if you don't want to affect the system performance.

Video BIOS Cacheable

Select Enabled allows caching of the video BIOS, resulting in better system performance. However, if any program writes to this memory area, a system error may result. The settings are Enabled and Disabled.

Chipset Features Setup

1. Press <ENTER> on “Chipset Features Setup” of the main menu screen.

AMIBIOS SETUP - CHIPSET FEATURES SETUP	
(C) 1999 American Megatrends, Inc. All Rights Reserved	
CPU Frequency Ratio	:12.0X
USB Function	:Enabled
USB Keyboard Support	:Disabled
Memory Hole	:Disabled
Graphics Aperture Size	:64MB
ICH Decode Select	:Subtractive
CPU Bist Enable	:Disabled
ICH Delayed Transaction	:Disabled
ICH DCB Enable	:Disabled
VGA Frame Buffer USWC	:Disabled
PCI Frame Buffer USWC	:Disabled
ESC:Quit ↑↓←→:Select Item F1 :Help PU/PD/+/- : Modify F5 :Old Values (Shift)F2: Color F6 :Load BIOS Defaults F7 :Load Setup Defaults	

2. Use <Up> and <Down> to choose the item and <PgUp> and <PgDn> keys to modify the highlighted item.
3. After you have finished with the Chipset Features Setup, press <ESC> to go back to the main menu.

Description of the item on screen follows:**CPU Frequency Ratio**

This option enables you to set the CPU ratio.

USB Function

Set this option to Enabled or Disabled the on-chip USB controller.

USB Keyboard Support

Select Enabled if your system contains a Universal Serial Bus (USB) controller and you have a USB keyboard.

Memory Hole

This option allows the end user to specify the location of a memory hole. The cycle matching the selected memory hole will be passed to the ISA bus. If Enabled, the selected hole is not remapped.

Graphics Aperture Size

This option determines the effective size of the graphics aperture used in the particular PAC configuration. The AGP aperture is memory-mapped, while graphics data structure can reside in a graphics aperture. The aperture range should be programmed as not cacheable in the processor cache, accesses with the aperture range are forwarded to the main memory, then PAC will translate the original issued address via a translation table which is maintained on the main memory. The option allows the selection of an aperture size of 4MB, 8MB, 16MB, 32MB, 64MB, 128MB and 256MB.

ICH Decode Select

This option allows you to select the PCI decode timing of ICH.

CPU BIST Enable

This option allows you Enable or Disable the CPU Built-In Self Test.

ICH Delayed Transaction

The chipset has an embedded 32-bit posted write buffer to support delay transactions cycles. Select Enabled to support compliance with PCI specification version 2.1.

ICH DCB Enable

This option allows you to Enable or Disable the ICH DMA Collection Buffer for LPC I/F.

VGA Frame Buffer USWC

This option allows you to Enable or Disable the VGA frame buffer.

PCI Frame Buffer USWC

This option allows you to Enable or Disable the PCI frame buffer.

Power Management Setup

1. Press <ENTER> on “Power Management Setup” of the main menu screen.

AMIBIOS SETUP - POWER MANAGEMENT SETUP			
(C) 1999 American Megatrends, Inc. All Rights Reserved			
IPCA Function	:Yes	Resume By Alarm	:Disabled
Sleep State	:S1/POS	Alarm Date	:15
Sleep State LED	:DualColor	Alarm Hour	:12
Standby Time Out (Minute)	:Disabled	Alarm Minute	:30
Keyboard & PS/2 Mouse	:Monitor	Alarm Second	:30
FDC/LPT/COM Ports	:Monitor		
SB & MSS Audio Ports	:Ignore		
MIDI Ports	:Ignore		
ADLIB Ports	:Ignore		
Primary Master IDE	:Monitor		
Primary Slave IDE	:Ignore		
Secondary Master IDE	:Monitor		
Secondary Slave IDE	:Ignore		
System Thermal	:Ignore		
Power Button Function	:On/Off		
Restore on AC/Power Loss	:Last State		
Wake Up On Ring	:Disabled		
Wake Up On Lan	:Disabled		
Wake Up On PME	:Disabled		
		ESC:Quit	↑↓←→:Select Item
		F1 :Help	PU/PD/+/- : Modify
		F5 :Old Values (Shift)	F2: Color
		F6 :Load BIOS Defaults	
		F7 :Load Setup Defaults	

2. Use <Up> and <Down> to choose the item and <PgUp> and <PgDn> keys to modify the highlighted item.
3. After you have finished with the Power Management Setup, press <ESC> to go back to the main menu.

Description of the item on screen follows:

IPCA Function

This item allows you to Enabled/Disabled the Advanced Configuration and Power Management (ACPI). The settings are Enabled and Disabled.

Sleep State

This option allows you to set which Sleep State will be used.

S1/POS - Power on Suspend.

The S1 sleeping state is a low wake-up latency sleeping state. In this state, no system context is lost (CPU or chipset) and hardware maintains all system context.

S3/STR - Suspend to RAM.

The S3 state is a low wake-up latency sleeping state where all system context is lost except the system memory. CPU, cache, and chipset context are lost in this state. Hardware maintains memory context and restores some CPU and L2 configuration context.

Sleep State LED

This option determines which state the Power LED will use. The settings are Blinking, Dual and Single. During Blinking, the power LED will blink when the system enters the suspend mode. When the mode is in Dual, the power LED will change its color. In Single mode, the power LED will always remain lit.

Standby Time Out (Minute)

This option specifies the length of a period of system inactivity while in Standby state. When this length of time expires, the computer enters Suspend power state. The settings are Disabled, 1 min, 2 min, 4 min, 8 min, 10 min, 20 min, 30 min, 40 min, 50 min or 60 min.

Keyboard & PS/2 Mouse/**FDC/LPT/COM Ports/****SB & MSS Audio Ports/****MIDI Ports/****ADLIB Ports/****Primary Master IDE/Primary Slave IDE/Secondary Master IDE/Secondary Slave IDE/System Thermal**

When set to Monitor, these options enabled event monitoring on the specified hardware interrupt request line. If set to Monitor and the computer is in a power saving state, AMI BIOS watches for activity on the specified IRQ line. The computer enters the full on power state if any activity occurs.

AMI BIOS reloads the Standby and Suspend time out timers if activity occurs on the specified IRQ line.

Power Button Function

During Suspend, if you push the switch once, the system goes into suspend mode and if you push it more than 4 seconds, the system will be turned off. During On/Off, the system will turn off once you push the switch.

Restore on AC/Power Loss

The settings are power on, power off or last state. During power on, after every AC power loss, the system will be turned on. During last status, after every AC power loss, whatever the system status, it will be the same when the AC power returns. During power off, after every AC power loss, the system will be turned off.

Wake Up On Ring/Wake Up On LAN

During Disabled, the system will ignore any incoming call from the modem/LAN. During Enabled, the system will boot up if there's an incoming call from the modem/LAN.

Note: If you have change the setting, you must let the system boot up until it goes to the operating system. Then, power off the system. This function will work the next time you power on.

Wake Up On PME

This option enables the system to comply with PCI specification version 2.2. PCI card should be present to enable power on or resume from the PME signal.

Resume By Alarm

This function is for setting the Date, Hour, Minute, and Second for your computer to boot up. During Disabled, you cannot use this function. During Enabled, Choose the Date, Hour, Minute, and Second:

Alarm Date	Select which day the system will boot up.
Alarm Hour	Select the hours for the system to boot up.
Alarm Minute	Select the minutes for the system to boot up.
Alarm Second	Select the seconds for the system to boot up.

Note: If you have change the setting, you must let the system boot up until it goes to the operating system. Then, power off the system. This function will work the next time you power on.

PNP/PCI Configuration

1. Press <ENTER> on “PNP/PCI Configuration” of the main menu screen.

AMIBIOS SETUP - PNP/PCI CONFIGURATION	
(C) 1999 American Megatrends, Inc. All Rights Reserved	
Clear ESCD	:No
PCI VGA Palette Snoop	:Disabled
DMA Channel 0	:PnP
DMA Channel 1	:PnP
DMA Channel 3	:PnP
DMA Channel 5	:PnP
DMA Channel 6	:PnP
DMA Channel 7	:PnP
IRQ3	:PCI/PnP
IRQ4	:PCI/PnP
IRQ5	:PCI/PnP
IRQ7	:PCI/PnP
IRQ9	:PCI/PnP
IRQ10	:PCI/PnP
IRQ11	:PCI/PnP
IRQ14	:PCI/PnP
IRQ15	:PCI/PnP
ESC:Quit ↑↓←→:Select Item F1 :Help PU/PD/+/- : Modify F5 :Old Values (Shift)F2: Color F6 :Load BIOS Defaults F7 :Load Setup Defaults	

2. Use <Up> and <Down> to choose the item and <PgUp> and <PgDn> keys to modify the highlighted item.
3. After you have finished with the PNP/PCI Configuration, press <ESC> to go back to the main menu.

Description of the item on screen follows:**Clear ESCD**

During Yes, this will clear ESCD data on every boot.

PCI VGA Palette Snoop

When this option is set to Enabled, multiple VGA devices operating on different buses can handle data from the CPU on each set of palette registers on every video device. Bit 5 of the command register in the PCI device configuration space is the VGA Palette Snoop bit (0 is disabled). For example, if there are two VGA devices in the computer (one PCI and ISA) and the Bit settings are:

Disabled-Data read and written by the CPU is only directed to the PCI VGA device's palette registers.

Enabled- Data read and written by the CPU is directed to both the PCI VGA device's palette registers and the ISA VGA device palette registers, permitting the palette registers of both devices to be identical.

This option must be set to Enabled if an ISA adapter card requires VGA palette snooping. The settings are Enabled or Disabled.

DMA Channel 0/1/3/5/6/7

These options specify the bus that the specified DMA channel is used. These options allow you to reserve DMAs for legacy ISA adapter cards.

These options determine if AMI® BIOS should remove a DMA from the available DMAs passed to devices that are configurable by the system BIOS. The available DMA pool is determined by reading the ESCD NVRAM. If more DMAs must be removed from the pool, the end user can use these options to reserve the DMA by assigning an ISA/EISA setting to it.

IRQ3/IRQ4/IRQ5/RQ7/IRQ9/IRQ10/IRQ11/IRQ14/IRQ15

These options specify the bus that the specified IRQ line is used on. These options allow you to reserve IRQs for legacy ISA adapter cards.

These options determine if AMI® BIOS should remove an IRQ from the pool of available IRQs passed to devices that are configurable by the system BIOS. The available IRQ pool is determined by reading the ESCD NVRAM. If more IRQs must be removed from the pool, the end user can use these options to reserve the IRQ by assigning an ISA/EISA setting to it. Onboard I/O is configured by AMI® BIOS. All IRQs used by onboard I/O are configured as PCI/PnP. If all IRQs are set to ISA/EISA and IRQ14 and 15 are allocated to the onboard PCI IDE, IRQ9 will still be available for PCI and PnP devices, because at least one IRQ must be available for PCI and PnP devices. The settings are ISA/EISA or PCI/PnP. The Optimal and Fail-Safe default settings are IRQ3 through 7 are ISA/EISA. The Optimal and Fail-Safe default settings PCI/PnP.

Integrated Peripherals

1. Press <ENTER> on "Integrated Peripherals" of the main menu screen.

AMIBIOS SETUP - INTEGRATED PERIPHERALS	
(C) 1999 American Megatrends, Inc. All Rights Reserved	
Floppy Controller	:Auto
Serial Port A	:Auto
Serial Port B	:Auto
Serial Port B Mode	:Normal
IR Duplex Mode	:Half Duplex
IR Pin Select	:IRRX/IRTX
CIR Port	:Disabled
CIR IRQ Select	:10
OnBoard Parallel Port	:Auto
Port Mode	:ECP
EPP Version	:N/A
Port IRQ	:Auto
Port DMA Channel	:Auto
OnBoard Midi Port	:300
Midi IRQ Select	:9
OnBoard Game Port	:200
On-Chip IDE	:Both
AC97 Audio Controller	:Auto
AC97 Modem Controller	:Auto
ESC:Quit ↑↓←→:Select Item F1 :Help PU/PD/+/- : Modify F5 :Old Values (Shift)F2: Color F6 :Load BIOS Defaults F7 :Load Setup Defaults	

2. Use <up> and <down> to choose the item and <PgUp> and <PgDn> keys to modify the highlighted item.
3. After you have finished with the Integrated Peripherals, press <ESC> to go back to the main menu.

Description of the item on screen follows:

Floppy Controller

Set this option to Auto for the BIOS to automatically detect the device

Serial Port A/Serial Port B

Choose Auto, for the BIOS to automatically detect the device.

If the ISA add-on card has				Onboard Serial port to be set at			
COM1 (I/O:3F8H)	COM2 (I/O:3F8H)	COM3 (I/O:3E8H)	COM4 (I/O:2E8H)	PORT1	IRQ ASSIGNED	PORT2	IRQ ASSIGNED
✓	✓	✓	✓	DISABLED	X	DISABLED	X
✓	✓	X	X	COM3	4	COM4	3
X	X	✓	✓	COM1	4	COM2	3
✓	X	X	✓	COM2	3	COM3	4
X	✓	✓	X	COM1	4	COM4	3
✓	✓	✓	X	COM4	3	DISABLED	X
✓	✓	X	✓	COM3	4	DISABLED	X
✓	X	✓	✓	COM2	3	DISABLED	X
X	✓	✓	✓	COM1	4	DISABLED	X
X	X	X	X	COM1	4	COM2	3
✓	X	X	X	COM2	3	COM3	4
X	✓	X	X	COM1	4	COM3	4
X	X	✓	X	COM1	4	COM2	3
X	X	X	✓	COM1	4	COM2	3

Note: If the onboard serial port interrupt and ISA add-on card interrupt are in conflict, the serial port will not work properly. Please disable one of the devices.

Serial Port B Mode

Choosing Normal will set the Serial Port B for normal use, not for IR device. Choosing IrDA or Ask IR will set it for use with IR device using these protocols.

IR Duplex Mode

Can be set as either Half or Full duplex.

IR Pin Select

Set this option to IRRX/IRTX when using an internal IR device which is connected to J5 connector.

Onboard CIR Port

Setting Enabled, the system support consumer IR and your device have to be connected to J5 connector.

CIR IRQ Select

Select IRQ 3, 4, 9, 10 or 11 to support CIR Interrupt.

Onboard Parallel Port

Choose Auto, the BIOS automatically assigned onboard parallel port to the available parallel port or disabled.

If the ISA add-on card has			Onboard parallel port to be set as	
LPT1 I/O:378H	LPT2 I/O:278H	LPT3 I/O:3BCH	PORT ASSIGNED	IRQ ASSIGNED
✓	✓	✓	Disabled	X
✓	✓	X	LPT3	5
✓	X	✓	LPT2	5
X	✓	✓	LPT1	7
✓	X	X	LPT2	5
X	✓	X	LPT1	7
X	X	✓	LPT1	7
X	X	X	LPT1	7

Note: *If the onboard parallel port interrupt and ISA add-on card interrupt are in conflict, the parallel port will not work properly. Please disable one of the devices.*

Port Mode

This option allows user to choose the operating mode of the onboard parallel port. The settings are Normal, SPP/EPP or ECP mode.

EPP Version

This option is for setting which EPP version will be used. The settings are 1.7 and 1.9.

Port IRQ

If the onboard parallel mode is not on auto mode, the user can select the interrupt line for onboard parallel port. We suggest that the user select the interrupt for the onboard parallel port as shown below:

Onboard parallel port set at	Parallel Port IRQ
LPT1(378H)	7
LPT2(278H)	5
LPT3(3BCH)	5

Port DMA Channel

This option allows user to choose port DMA channel 1 to 3 for the onboard parallel port on ECP mode.

OnBoard MIDI Port

Choose 290H, 292H, 300H, 330H to support MIDI devices.

MIDI IRQ Select

Choose 5, 7, 9, 10 to support MIDI device interrupt.

OnBoard Game Port

Choose 200H, 208H to support Joystick device.

Note: If Hardware Audio is onboard, the three items above in the peripheral setup will not be shown.

On-Chip IDE

Set this option to enable or disable on-chip IDE controller.

AC97 Audio/AC'97 Modem Controller

Set this option to Auto for the BIOS to automatically detect the AC97 audio and modem controller.

Hardware Monitor Setup

The Hardware Monitor Setup is used to set the CPU speed and monitor the current CPU Temperature, CPU Fan speed, Chassis Fan Speed, Power fan speed, Vcore, etc. This is only available if there is Hardware Monitor onboard.

1. Press <ENTER> on “Hardware Monitor Setup” of the main menu screen.

AMIBIOS SETUP - HARDWARE MONITOR SETUP	
(C) 1999 American Megatrends, Inc. All Rights Reserved	
---System Hardware Monitor---	
Chassis Intrusion	:Disabled
CPU Temperature	:40°C/104°F
System Temperature	:32°C/89°F
CPU Fan Speed	:0 RPM
System Fan Speed	:0 RPM
Power Fan Speed	:4354 RPM
CPU VID	:1.75V
Vcore	:1.648 V
1.8V	:1.824 V
Vio	:3.312 V
+ 5.0V	:5.223 V
+ 12.0V	:11.376 V
- 12.0V	:-11.497 V
- 5.0V	:-4.926 V
Battery	:3.136 V
+5V SB	:5.090 V
ESC:Quit ↑↓←→:Select Item F1 :Help PU/PD/+/- : Modify F5 :Old Values (Shift)F2: Color F6 :Load BIOS Defaults F7 :Load Setup Defaults	

2. Use <Up> and <Down> to choose the item and <PgUp> and <PgDn> keys to modify the highlighted item.
3. After you have finished with the Hardware Monitor Setup, press <ESC> to go back to the main menu.

Description of the item on screen follows:**Chassis Intrusion**

Set this option to Enabled, Reset, or Disabled the chassis intrusion detector. During Enabled, any intrusion on the system chassis will be recorded. The next time you turn on the system, it will show a warning message. To be able to clear those warning, choose reset. After clearing the message it will go back to Enabled.

**CPU Temperature/System Temperature/CPU Fan Speed/
System Fan Speed/Power Fan Speed/CPU VID/Vcore/1.8V/Vio/
+5V/+12V/-12V/-5V/Battery/5VSB**

This will show the CPU/Fan/System voltage chart and Fan speed.

Supervisor/User Password

This Main Menu item lets you configure the system so that a password is required each time the system boots or an attempt is made to enter the Setup program. Supervisor Password allows you to change all CMOS settings but the User Password setting doesn't have this function. The way to set up the passwords for both Supervisor and User are as follow:

1. Choose "Supervisor/User Password" in the Main Menu and press <Enter>. The following message appears:

"Enter New Supervisor/User Password:"

2. The first time you run this option, enter your password up to 6 characters only and press <Enter>. The screen will not display the entered characters. For no password, just press <Enter>.
3. After you enter the password, the following message appears prompting you to confirm the password:

"Retype New Supervisor/User Password:"

4. Enter exactly the same password you just typed in to confirm the password and press <Enter>.
 5. Move the cursor to Save and Exit Setup to save the password.
 6. If you need to delete the password you entered before, choose the Supervisor/User Password and press <Enter>. It will delete the password that you had before.
 7. Move the cursor to Save and Exit Setup to save the option you did. Otherwise, the old password will still be there when you turn on your machine next time.
-

IDE HDD Auto Detection

You can use this utility to automatically detect the characteristics of most hard drives.

```

AMIBIOS SETUP - STANDARD CMOS SETUP
(C)1999 American Megatrends, Inc. All Rights Reserved
-----
Date (mm/dd/yyyy): Fri Jul 21, 2000
Time (hh/mm/ss): 01:01:34

      TYPE          SIZE  CYLS  HEAD  PRECOMP  LANDZ  SECTOR  MODE
      -----
Pri Master :
Pri Slave  :
Sec Master :
Sec Slave  :

Floppy Drive A:  Not Installed
Floppy Drive B:  Not Installed

Base Memory : 0 KB
Other Memory: 384 Kb
Extended Memory : 0 Mb
Total Memory : 1 Mb

Boot Sector Virus Protection Disabled

Detecting drive parameters:
Press ESC to Abort

ESC:Exit
↑↓:Select Item
PU/PD/+/- : Modify
(shift) F2: Color

```

Chapter 4

AWARD® BIOS SETUP

Award® BIOS ROM has a built-in Setup program that allows users to modify the basic system configuration. This type of information is stored in battery-backed RAM (CMOS RAM), so that it retains the Setup information when the power is turned off.

Entering Setup

Power on the computer and press immediately to allow you to enter Setup. The other way to enter Setup is to power on the computer. When the below message appears briefly at the bottom of the screen during the POST (Power On Self Test), press key or simultaneously press <Ctrl>, <Alt>, and <Esc> keys.

TO ENTER SETUP BEFORE BOOT, PRESS <CTRL-ALT-ESC>
OR KEY

If the message disappears before you respond and you still wish to enter Setup, restart the system to try again by turning it OFF then ON or pressing the “RESET” button on the system case. You may also restart by simultaneously pressing <Ctrl>, <Alt>, and <Delete> keys. If you do not press the keys at the correct time and the system does not boot, an error message will be displayed and you will again be asked to,

PRESS <F1> TO CONTINUE, <CTRL-ALT-ESC>
OR TO ENTER SETUP

Getting Help

Main Menu

The on-line description of the highlighted setup function is displayed at the bottom of the screen.

Status Page Setup Menu/Option Page Setup Menu

Press F1 to pop up a small help window that describes the appropriate keys to use and the possible selections for the highlighted item. To exit the Help Window, press <Esc>.

Advanced Chipset Features

Use this menu to change the values in the chipset registers and optimize your system's performance.

Integrated Peripherals

Use this menu to specify your settings for integrated peripherals.

Power Management Setup

Use this menu to specify your settings for power management.

PnP/PCI Configuration

This entry appears if your system supports PnP/PCI.

PC Health Status

This entry shows your PC health status.

Frequency/Voltage Control

Use this menu to specify your settings for frequency/voltage control.

Load Fail-Safe Defaults

Use this menu to load the BIOS default values for the minimal/stable performance for your system to operate.

Load Optimized Defaults

Use this menu to load the BIOS default values that are factory settings for optimal performance system operations.

Supervisor/User Password

Use this menu to set User and Supervisor Passwords.

Save & Exit Setup

Save CMOS value changes to CMOS and exit setup.

Exit Without Saving

Abandon all CMOS value changes and exit setup.

Standard CMOS Setup

The items in Standard CMOS Setup Menu are divided into 10 categories. Each category includes no, one or more than one setup items. Use the arrow keys to highlight the item and then use the <PgUp> or <PgDn> keys to select the value you want in each item.

CMOS Setup Utility - Copyright(C) 1984-2000 Award Software
Standard CMOS Setup

Date(mm:dd:yy):	Fri, Feb 28,1999	Item Help
Time(hh:mm:ss):	00:00:00	
IDE Primary Master	Press Enter 2557MB	Menu Level >
IDE Primary Slave	Press Enter None	
IDE Secondary Master	Press Enter None	
IDE Secondary Slave	Press Enter None	
Drive A	1.44M, 3.5in.	
Drive B	None	
Video	EGA/VGA	
Halt On	All Errors	
Based Memory	640K	
Extended Memory	64512K	
Total Memory	65536K	
↑↓ →← Move Enter:Select +/-/PU/PD:Value F10:Save ESC:Exit F1:General Help F5:Previous Values F6:Fail-safe defaults F7:Optimized Defaults		

Date

The date format is <day><month> <date> <year>.

Day	Day of the week, from Sun to Sat, determined by BIOS. Read-only.
month	The month from Jan. through Dec.
date	The date from 1 to 31 can be keyed by numeric function keys.
year	The year, depends on the year of the BIOS

Time

The time format is <hour> <minute> <second>.

PrimaryMaster/PrimarySlave**SecondaryMaster/Secondary Slave**

Press PgUp/<+> or PgDn/<-> to select Manual, None, Auto type.

Note that the specifications of your drive must match with the drive table. The hard disk will not work properly if you enter improper information for this category. If your hard disk drive type is not matched or listed, you can use Manual to define your own drive type manually.

If you select Manual, related information is asked to be entered to the following items. Enter the information directly from the keyboard. This information should be provided in the documentation from your hard disk vendor or the system manufacturer.

If the controller of HDD interface is SCSI, the selection shall be
“None”.

If the controller of HDD interface is CD-ROM, the selection shall be
“None”.

Access Mode	The settings are Auto, Normal, Large,LBA.
Cylinder	number of cylinders
Head	number of heads
Precomp	write precom
Landing Zone	landing zone
Sector	number of sectors

Advanced BIOS Features

CMOS Setup Utility - Copyright(C) 1984-2000 Award Software
Advanced BIOS Features

Virus Warning	Disabled	Item Help
BIOS Flash Write Control	Disabled	
CPU L1 & L2 Cache	Enabled	Menu Level >
Quick Power On Self Test	Disabled	
First Boot Device	Floppy	
Second Boot Device	HDD-0	
Third Boot Device	LS120	
Boot Other Device	Enabled	
Swap Floppy Drive	Disabled	
Boot Up Floppy Seek	Enabled	
Boot Up Numlock Status	On	
Gate A20 Option	Fast	
Typematic Rate Setting	Disabled	
Typematic Rate (Chars/Sec)	6	
Typematic Delay (Msec)	250	
Security Option	Setup	
OS Select for DRAM > 64MB	Non-OS2	
HDD S.M.A.R.T. Capability	Disabled	
Report No FDD for Win 95	No	
↑ ↓ → ← Move Enter:Select +/-/PU/PD:Value F10:Save ESC:Exit F1:General Help F5:Previous Values F6:Fail-safe defaults F7:Optimized Defaults		

Virus Warning

Allows you to choose the VIRUS Warning feature for IDE Hard Disk boot sector protection. If this function is enabled and someone attempt to write data into this area, BIOS will show a warning message on screen and alarm beep.

Disable(default) No warning message to appear when anything attempts to access the boot sector or hard disk partition table.

Enable Activates automatically when the system boots up causing a warning message to appear when anything attempts to access the boot sector of hard disk partition table.

BIOS Flash Write Control

This option allows you to Enabled or Disabled the BIOS flash write control.

CPU L1 & L2 Internal Cache

Cache memory is additional memory that is much faster than the conventional DRAM (system memory). When the CPU requests data, the system transfers the requested data from the main DRAM into cache memory, for even faster access by the CPU.

Enabled (default) Enable cache

Disabled Disable cache

Note: The internal cache is built in the processor.

Quick Power On Self Test

This category speeds up Power On Self Test (POST) after you power on the computer. If this is set to Enabled, BIOS will shorten or skip some check items during POST.

Enabled (default) Enable quick POST

Disabled Normal POST

First/Second/Third Boot Device/Other Boot Device

The BIOS attempts to load the operating system from the devices in the sequence selected in these items. The settings are Floppy, LS120, HDD-0/SCSI, CD-ROM, HDD-1/HDD-2/HDD-3, ZIP100, USB-FDD, USB-ZIP, USB-CDROM, USB-HDD, LAN, Disabled.

Swap Floppy Drive

Switches the floppy disk drives between being designated as A and B. Default is Disabled.

Boot Up Floppy Seek

During POST, BIOS will determine if the floppy disk drive installed is 40 or 80 tracks. 360K type is 40 tracks while 760K, 1.2M and 1.44M are all 80 tracks.

Boot Up NumLock Status

The default value is On.

On (default) Keypad is numeric keys.

Off Keypad is arrow keys.

Gate A20 Option

Normal The A20 signal is controlled by keyboard controller or chipset hardware.

Fast(default) The A20 signal is controlled by port 92 or chipset specific method.

Typematic Rate Setting

Key strokes repeat at a rate determined by the keyboard controller. When enabled, the typematic rate and typematic delay can be selected. The settings are Enabled and Disabled.

Typematic Rate (Chars/Sec)

Sets the number of times a second to repeat a key stroke when you hold the key down. The settings are 6, 8, 10, 12, 15, 20, 24 and 30.

Typematic Delay (Msec)

Sets the delay time after the key is held down before it begins to repeat the keystroke. The settings are 250, 500, 750 and 1000.

Security Option

This category allows you to limit access to the system and Setup, or just to Setup.

- | | |
|-----------------------|---|
| System | The system will not boot and access to Setup will be denied if the correct password is not entered at the prompt. |
| Setup(default) | The system will boot, but access to Setup will be denied if the correct password is not entered at the prompt. |

OS Selection for DRAM > 64MB

Allows OS2® to be used with > 64 MB of DRAM. Settings are Non-OS/2 (default) and OS2. Set to OS/2 if using more than 64MB and running OS/2®.

HDD S.M.A.R.T Capability

This item allows you to Enabled or Disabled the HDD S.M.A.R.T (Self-Monitoring Analysis and Reporting Technology) Capability. The default setting is Disabled.

Report No FDD For Win 95

Whether report no FDD for Win 95 or not. The settings are: Yes, No.

Advanced Chipset Features

The Advanced Chipset Features Setup option is used to change the values of the chipset registers. These registers control most of the system options in the computer.

Choose the “ADVANCED CHIPSET FEATURES” from the Main Menu and the following screen will appear.

CMOS Setup Utility - Copyright(C) 1984-2000 Award Software
Advanced Chipset Features

RDRAM Bus Frequency	Auto	Item Help
DRAM Data Integrity Mode	Non-ECC	
System BIOS Cacheable	Disabled	
Video BIOS Cacheable	Disabled	
Memory Hole at 15M-16M	Disabled	
Delayed Transaction	Enabled	
AGP Aperture Size (MB)	64	
		Menu Level >
↑↓ →← Move Enter:Select +/-/PU/PD=Value F10:Save ESC:Exit F1:General Help F5:Previous Values F6:Fail-safe defaults F7:Optimized Defaults		

Note: Change these settings only if you are familiar with the chipset.

RDRAM Bus Frequency

This will show the RDRAM Bus Frequency during boot-up. The settings are Auto, 400MHz and 300MHz.

DRAM Data Integrity Mode

This option allows you to select the Parity or ECC (Error-Checking and Correcting), according to the type of installed DRAM.

System BIOS Cacheable

Selecting *Enabled* allows caching of the system BIOS ROM at F0000h-FFFFFh, resulting in better system performance. However, if any program writes to this memory area, a system error may result. The settings are: Enabled and Disabled.

Video BIOS Cacheable

Select Enabled allows caching of the video BIOS, resulting in better system performance. However, if any program writes to this memory area, a system error may result. The settings are: Enabled and Disabled.

Memory Hole At 15M-16M

You can reserve this area of system memory for ISA adapter ROM. When this area is reserved, it cannot be cached. The user information of peripherals that need to use this area of system memory usually discusses their memory requirements. The settings are: Enabled and Disabled.

Delayed Transaction

The chipset has an embedded 32-bit posted write buffer to support delay transactions cycles. Select *Enabled* to support compliance with PCI specification version 2.1. The settings are Enabled and Disabled.

AGP Aperture Size (MB)

This option determines the effective size of the graphics aperture used in the particular PAC configuration. The AGP aperture is memory-mapped, while graphics data structure can reside in a graphics aperture. The aperture range should be programmed as not cacheable in the processor cache, accesses with the aperture range are forwarded to the main memory, then PAC will translate the original issued address via a translation table that is maintained on the main memory. The option allows the selection of an aperture size of 4MB, 8MB, 16MB, 32MB, 64MB, 128MB and 256MB.

Integrated Peripherals

CMOS Setup Utility - Copyright(C) 1984-2000 Award Software
 Integrated Peripherals

OnChip Primary PCI IDE	Enabled	Item Help
OnChip Secondary PCI IDE	Enabled	
IDE Primary Master PIO	Auto	Menu Level >
IDE Primary Slave PIO	Auto	
IDE Secondary Master PIO	Auto	
IDE Secondary Slave PIO	Auto	
IDE Primary Master UDMA	Auto	
IDE Primary Slave UDMA	Auto	
IDE Secondary Master UDMA	Auto	
IDE Secondary Slave UDMA	Auto	
USB Controller	Enabled	
USB Keyboard Support	Disabled	
Init Display First	AGP	
AC97 Audio	Auto	
AC97 Modem	Auto	
IDE HDD Block Mode	Enabled	
Power On Function	Button Only	
KB Power On Password	Disabled	
KB Power On Password	Enter	
Hot Key Power On	Ctrl-F1	
Onboard FDC Controller	Enabled	
Onboard Serial Port 1	3F8/IRQ4	
Onboard Serial Port 2	2F8/IRQ3	
↑↓ → ← Move Enter:Select +/-/PU/PD=Value F10:Save ESC:Exit F1:General Help F5:Previous Values F6:Fail-safe defaults F7:Optimized Defaults		

UART Mode Select	Normal
RxD, TxD Active	Hi, Lo
IR Transmission Delay	Enabled
UR2 Duplex Mode	Half
USE IR Pins	IR-Rx2Tx2
Onboard Parallel Port	378/IRQ7
Parallel Port Mode	SPP
EPP Mode Select	EPP 1.7
ECP Mode use UDMA	3
PWRON After PWR-Fail	Off
Game Port Address	201
Midi Port Address	330
Midi Port IRQ	10
Power Status LED	Blinking

OnChip Primary/Secondary PCI IDE

The integrated peripheral controller contains an IDE interface with support for two IDE channels. Select *Enabled* to activate each channel separately. The settings are: Enabled and Disabled.

IDE Primary/Secondary Master/Slave PIO

The four IDE PIO (Programmed Input/Output) fields let you set a PIO mode (0-4) for each of the four IDE devices that the onboard IDE interface supports. Modes 0 through 4 provide successively increased performance. In Auto mode, the system automatically determines the best mode for each device. The settings are: Auto, Mode 0, Mode 1, Mode 2, Mode 3, Mode 4.

IDE Primary/Secondary Master/Slave UDMA

Ultra DMA/33 implementation is possible only if your IDE hard drive supports it and the operating environment includes a DMA driver (Windows 95 OSR2 or a third-party IDE bus master driver). If your hard drive and your system software both support Ultra DMA/33, Ultra DMA/66 select Auto to enable BIOS support. The settings are Auto and Disabled.

USB Controller

Select *Enabled* if your system contains a Universal Serial Bus (USB) controller and you have USB peripherals. The settings are Enabled and Disabled.

USB Keyboard Support

Select *Enabled* if your system contains a Universal Serial Bus (USB) controller and you have a USB keyboard. The settings are Enabled and Disabled.

Init Display First

Initialize the AGP video display before initializing any other display device on the system. Thus the AGP display becomes the primary display. The settings are PCI slot and AGP.

AC97 Audio

This item allows you to decide to Enable/Disable the 850 chipset family to support AC97 Audio.

AC97 Modem

This item allows you to Enabled or Disabled the AC97 Modem.

IDE HDD Block Mode

Block mode is also called block transfer, multiple commands, or multiple sector read/write. If your IDE hard drive supports block mode (most new drives do), select Enabled for automatic detection of the optimal number of block read/writes per sector the drive can support. The settings are Enabled and Disabled.

Power On Function

This function allows you to select the item to power on the system. The settings are Button Only, Mouse Left, Mouse Right, Password, Hotkey Power On and Keyboard 98.

KB Power on Password

Normally, this item is unselectable. To Enabled this function choose the "Password" setting in the Power On Function. This will allow you to input the password for the KB Power On.

Onboard FDC Controller

Select Enabled if your system has a floppy disk controller (FDD) installed on the system board and you wish to use it. If you install add-on FDC or the system has no floppy drive, select Disabled in this field. The settings are: Enabled and Disabled.

Onboard Serial Port 1/Port 2

Select an address and corresponding interrupt for the first and second serial ports. The settings are: 3F8/IRQ4, 2E8/IRQ3, 3E8/IRQ4, 2F8/IRQ3, Disabled, Auto.

UART Mode Select

This item allows you to determine which InfraRed(IR) function of the onboard I/O chip, this functions uses.

RxD, TxD Active

This item allows you to determine the active of RxD, TxD. The settings are “Hi,Hi”, “Lo,Lo”, “Lo,Hi” and “Hi,Lo”.

IR Transmission Delay

This item allows you to Enabled/Disabled the IR transmission delay. The settings are Enabled or Disabled.

UR2 Duplex Mode

This item allows you to select the IR half.full duplex function. The settings are Half and Full.

Use IR Pins

Consult your IR peripheral documentation to select the correct setting pf the TxD and RxD signals.

Onboard Parallel Port

Select a logical LPT port address and corresponding interrupt for the physical parallel port.

Onboard Parallel Mode

To operate the onboard parallel port as Standard Parallel Port only, choose “SPP.” To operate the onboard parallel port in the EPP modes simultaneously, choose “EPP.” By choosing “ECP”, the onboard parallel port will operate in ECP mode only. Choosing “ECP + EPP” will allow the onboard parallel port to support both the ECP and EPP modes simultaneously. The ECP mode has to use the DMA channel, so choose the onboard parallel port with the ECP feature. After selecting it, the following message will appear: “ECP Mode Use DMA” At this time, the user can choose between DMA channels 3 or 1. The onboard parallel port is EPP Spec. compliant, so after the user chooses the onboard parallel port with the EPP function, the following message will be displayed on the screen: “EPP Mode Select.” At this time either EPP 1.7 spec. or EPP 1.9 spec. can be chosen.

- SPP:** Standard Parallel Port
- EPP:** Enhanced Parallel Port
- ECP:** Extended Capability Port

PWRON After PWR-FAIL

This option will determine how the system will power on after a power failure.

Game Port Address/Midi Port Address

This will determine which Address the Game Port/Midi Port will use.

Midi Port IRQ

This determines the IRQ in which the MIDI Port can use.

Power Status LED

This item determines which state the Power LED will use. The settings are Blinking (default), Dual, and Single. During blinking, the power LED will blink when the system enters the suspend mode. When the mode is in Dual, the power LED will change its color. Choose the single and the power LED will always remain lit.

Power Management Setup

The Power Management Setup allows you to configure you system to most effectively save energy while operating in a manner consistent with your own style of computer use.

CMOS Setup Utility - Copyright(C) 1984-2000 Award Software
Power Management Setup

ACPI Suspend Type	S1(POS)	Item Help
Power Management	User Define	
Video Off Method	DPMS	Menu Level >
Video Off In Suspend	Yes	
Suspend Type	Stop Grant	
Modem Use IRQ	3	
Suspend Mode	Disabled	
HDD Power Down	Disabled	
Soft-Off by PWR-BTTN	Instant-Off	
Wake-Up by PCI Card	Enabled	
Power On by Ring	Enabled	
Wake-Up on LAN	Enabled	
CPU Thermal-Throtting	50%	
Resume By Alarm	Disabled	
Date(of Month) Alarm	0	
Date(hh:mm:ss)	0 0 0	
Reload Global Timer Events		
Primary IDE 0	Disabled	
Primary IDE 1	Disabled	
Secondary IDE 0	Disabled	
Secondary IDE 1	Disabled	
FDD, COM, LPT Port	Disabled	
PCI PIRQ[A-D]#	Disabled	
↑ ↓ → ← Move Enter:Select +/-/PU/PD:Value F10:Save ESC:Exit F1:General Help F5:Previous Values F6:Fail-safe defaults F7:Optimized Defaults		

ACPI Suspend Type

This item will set which ACPI suspend type will be used.

S1 (POS)

The S1 sleeping state is low wake-up latency sleeping state. In this state, no system context is lost (CPU or chipset) and hardware maintains all system context.

S3 (STR)

The S3 state is a low wake-up latency sleeping state where all system context is lost except system memory. CPU, cache, and chipset context are lost in this state. Hardware maintains memory context and restores some CPU and L2 configuration context.

Power Management

This category allows you to select the type (or degree) of power saving and is directly related to the following modes:

1. Suspend Mode
2. HDD Power Down

There are three selections for Power Management, two of which have fixed mode settings.

Min. Power Saving	Minimum power management. Suspend Mode = 1 hr., and HDD Power Down = 15 min.
Max. Power Saving	Maximum power management — Suspend Mode = 1 min., and HDD Power Down = 1 min.
User Defined (default)	Allows you to set each mode individually. When not disabled, each of the ranges are from 1 min. to 1 hr. except for HDD Power Down which ranges from 1 min. to 15 min. and disable.

Video Off Method

This determines the manner in which the monitor is blanked.

V/HSYNC+Blank	This selection will cause the system to turn off the vertical and horizontal synchronization ports and write blanks to the video buffer.
Blank Screen	This option only writes blanks to the video buffer.
DPMS (default)	Initial display power management signaling.

Video Off In Suspend

This determines the manner in which the monitor is blanked. The settings are Yes and No.

Suspend Type

Select the Suspend Type. The settings are: PWRON Suspend, Stop Grant.

Modem Use IRQ

This determines the IRQ in which the MODEM can use. The settings are 3, 4, 5, 7, 9, 10, 11 and NA.

Suspend Mode

When enabled and after the set time of system inactivity, all devices except the CPU will be shut off. The settings are 1/2/4/8/12/20/30/40 Min, 1 Hour and Disabled.

HDD Power Down

When enabled and after the set time of system inactivity, the hard disk drive will be powered down while all other devices remain active. The settings are: 1/2/3/4/5/6/7/8/9/10/11/12/13/14/15Min and Disabled.

Soft-Off by PWR-BTTN

Pressing the power button for more than 4 seconds forces the system to enter the Soft-Off state. The settings are Delay 4 Sec and Instant-Off.

Wake-Up by PCI Card

This will enable the system to wake up through PCI Card peripheral. The settings are Enabled and Disabled.

Power On by Ring

During Disabled, the system will ignore any incoming call from the modem. During Enabled, the system will boot up if there's an incoming call from the modem.

Wake-Up on LAN

To use this function, you need a LAN add-on card which support power on functions. It should also support the wake-up on LAN jumper (JWOL1).

Enabled	Wake up on LAN supported.
Disabled	Wake up on LAN not supported.

CPU Thermal-Throttling

Select the CPU THRM-Throttling rate. The settings are: 12.5%, 25.0%, 37.5%, 50.0%, 62.5%, 75.0%, 87.5%.

Resume by Alarm

This function is for setting date and time for your computer to boot up. During Disabled, you cannot use this function. During Enabled, choose the Date and Time Alarm:

Date(of month) Alarm	You can choose which month the system will boot up. Set to 0, to boot every day.
Time(hh:mm:ss) Alarm	You can choose what hour, minute and second the system will boot up.

Note: If you have change the setting, you must let the system boot up until it goes to the operating system, before this function will work.

Reload Global Timer Events

Reload Global Timer events are I/O events whose occurrence can prevent the system from entering a power saving mode or can awaken the system from such a mode. In effect, the system remains alert for anything which occurs to a device which is configured as *Enabled* , even when the system is in a power down mode.

Primary IDE 0

Primary IDE 1

Secondary IDE 0

Secondary IDE 1

FDD, COM, LPT Port

PCIPIRQ[A-D]#

PnP/PCI Configuration Setup

This section describes configuring the PCI bus system. PCI, or **P**ersonal **C**omputer **I**nterconnect, is a system which allows I/O devices to operate at speeds nearing the speed the CPU itself uses when communicating with its own special components. This section covers some very technical items and it is strongly recommended that only experienced users should make any changes to the default settings.

CMOS Setup Utility - Copyright(C) 1984-2000 Award Software
PnP/PCI Configuration Setup

Reset Configuration Data	Disabled	Item Help
Resources Controlled By IRQ Resources	Auto (ESCD) Press Enter	
PCI/VGA Palette Snoop	Disabled	Menu Level >
↑ ↓ → ← Move Enter:Select +/-/PU/PD:Value F10:Save ESC:Exit F1:General Help F5:Previous Values F6:Fail-safe defaults F7:Optimized Defaults		

Reset Configuration Data

Normally, you leave this field to Disabled. Select Enabled to reset Extended System Configuration Data (ESCD) when you exit Setup if you have installed a new add-on and the system reconfiguration has caused such a serious conflict that the operating system can not boot.

The settings are Enabled and Disabled .

Resource Controlled By

The Award Plug and Play BIOS has the capacity to automatically configure all of the boot and Plug and Play compatible devices. However, this capability means absolutely nothing unless you are using a Plug and Play operating system such as Windows®95/98. If you set this field to “manual” choose specific resources by going into each of the sub menu that follows this field (a sub menu is preceded by a “>”). The settings are Auto (ESCD) and Manual.

IRQ Resources

When resources are controlled manually, assign each system interrupt a type, depending on the type of device using the interrupt.

PCI/VGA Palette Snoop

Leave this field at *Disabled*. The settings are Enabled and Disabled.

PC Health Status

This section shows the Status of your CPU, Fan, Warning for overall system status.

CMOS Setup Utility - Copyright(C) 1984-2000 Award Software
 PC Health Status

Chassis Intrusion Detect	Disabled	Item Help
CPU Warning Temperature	Disabled	
Current System Temp	39°C/102°F	Menu Level >
Current CPU Temperature	66°C/150°F	
Current CPU FAN	5532RPM	
Current SYS Fan	0RPM	
Current PWR Fan	0RPM	
Vcore	1.65V	
+1.88V	1.88V	
Vio	3.24V	
+5V	4.89V	
+12V	11.79V	
-12V	-12.19V	
-5V	-4.53V	
VBAT(V)	3.10V	
5VSB(V)	5.37V	
Shutdown Temperature	Disabled	
↑ ↓ → ← Move Enter:Select +/-/PU/PD:Value F10:Save ESC:Exit F1:General Help F5:Previous Values F6:Fail-safe defaults F7:Optimized Defaults		

Chassis Intrusion Detect

Set this option to Enabled, Reset, or Disabled the chassis intrusion detector. During Enabled, any intrusion on the system chassis will be recorded. The next time you turn on the system, it will show a warning message. To be able to clear those warning, choose reset. After clearing the message it will go back to Enabled.

CPU Warning Temperature

Select the combination of lower and upper limits for the CPU temperature. If the CPU temperature extends beyond either limit, any warning mechanism programmed into your system will be activated.

Current System Temp/Current CPU Temperature/Current CPU Fan (optional)/SYS Fan (optional)/PWR Fan/Vcore/+1.88V/Vio/+5V/+12V/-12V/-5V/VBAT(V)/5VSB(V)

This will show the CPU/FAN/System voltage chart and FAN Speed.

Shutdown Temperature

This option is for setting the Shutdown temperature level for the processor. When the processor reach the temperature you set, this will shutdown the system.

Frequency/Voltage Control

This section is for setting CPU Frequency/Voltage Control.

CMOS Setup Utility - Copyright(C) 1984-2000 Award Software
Frequency/Voltage Control

CPU Clock Ratio x8	Item Help
	Menu Level >
↑↓ →← Move Enter:Select +/-/PU/PD:Value F10:Save ESC:Exit F1:General Help F5:Previous Values F6:Fail-safe defaults F7:Optimized Defaults	

CPU Clock Ratio

The CPU Clock Ratio provides flexibility for overclockers from x8 to x23.

Note: Most of the Pentium® 4 processor doesn't support clock ratio adjustment. Always consult your reseller for further instructions.

Load Fail-Safe/Optimized Defaults

Load Fail-Safe Defaults

When you press <Enter> on this item, you get a confirmation dialog box with a message similar to:

Load Fail-Safe Defaults (Y/N) ? N

Pressing 'Y' loads the BIOS default values for the most stable, minimal-performance system operations.

Load Optimized Defaults

When you press <Enter> on this item, you get a confirmation dialog box with a message similar to:

Load Optimized Defaults (Y/N) ? N

Pressing 'Y' loads the default values that are factory settings for optimal performance system operations.

Set Supervisor/User Password

You can set either supervisor or user password, or both of them. The differences are:

Supervisor password: Can enter and change the options of the setup menus.

User password: Can only enter but do not have the right to change the options of the setup menus. When you select this function, the following message will appear at the center of the screen to assist you in creating a password.

ENTER PASSWORD:

Type the password, up to eight characters in length, and press <Enter>. The password typed now will clear any previously entered password from CMOS memory. You will be asked to confirm the password. Type the password again and press <Enter>. You may also press <Esc> to abort the selection and not enter a password.

To disable a password, just press <Enter> when you are prompted to enter the password. A message will confirm the password will be disabled. Once the password is disabled, the system will boot and you can enter Setup freely.

PASSWORD DISABLED.

When a password has been enabled, you will be prompted to enter it every time you try to enter Setup. This prevents an unauthorized person from changing any part of your system configuration.

Additionally, when a password is enabled, you can also require the BIOS to request a password every time your system is rebooted. This would prevent unauthorized use of your computer.

You determine when the password is required within the BIOS Features Setup Menu and its Security option. If the Security option is set to “System”, the password will be required both at boot and at entry to Setup. If set to “Setup”, prompting only occurs when trying to enter Setup.

Chapter 5

CREATIVE AUDIO DRIVER (OPTIONAL)

Creative CT5880

The Creative® CT5880 digital controller provides the next generation of audio performance to the PC market.

Features

- SoundScape WaveTable Synthesizer.
- Full DOS Game Compatibility.
- PCI Bus Master for fast DMA.
- Fully Compliant with PC97 Power Management Specification.

System Requirements

This section describes system requirements for the Audio Driver installation and Usage.

Computer	Intel® Pentium® 4 processor or higher
Operating system	DOS 5.0 or higher, Windows® 95, Windows® 98, Windows® NT 3.51 or 4.0
CD-ROM	Double Speed or Higher
Chipset	Creative® CT5880

Audio Driver Setup

Insert the CD-title into your CD-ROM drive. This CD will auto-run. This will display installation for Microsoft Direct X 7.0a, Creative PCI 128 Sound Driver and Intel Inf Update. Please make sure that you have finished the installation for Intel Inf Update before proceeding to install the Audio Driver. To install the audio driver, click on the button for automatic installation.

Windows® 95/98

If you start Windows® 95/98, this will automatically detect this hardware onboard “PCI Multimedia Audio Device” and “Gameport Joystick”. You need to click “Next”, then “Finish”. Do not click on the “Cancel”. The driver need these ID.

Audio Driver Installation Procedure:

- Step 1:** Insert the provided CD_ROM disk into the CD-ROM drive.
- Step 2:** Look for the CD_ROM drive, double click on the CD_ROM icon. This will show the setup screen.
- Step 3:** Click on “Creative PCI 128 Sound Driver” sound drivers icon.
- Step 4:** This will copy the audio drivers into the hard drive.
- Step 5:** A message will appear stating you must restart the Windows® 95/98 system, select **yes** to restart.

Windows® NT 4.0**Audio Driver Installation Procedure:**

- Step 1:** Insert the provided CD_ROM disk into the CD-ROM drive.
- Step 2:** Look for the CD_ROM drive, double click on the CD_ROM icon. This will show the setup screen.
- Step 3:** Click on “Creative PCI 128 Sound Driver” icon.
- Step 4:** This will copy the audio drivers into the hard drive.
- Step 5:** A message will appear stating you must restart the Windows® NT 4.0 system, select **yes** to restart.