



# Intel<sup>®</sup> Desktop Board D850GB

## Technical Product Specification



*September 2000*

*Order Number A26080-001*

The Intel<sup>®</sup> Desktop Board D850GB may contain design defects or errors known as errata that may cause the product to deviate from published specifications. Current characterized errata are documented in the Intel Desktop Board D850GB Specification Update.

# Revision History

---

Revision	Revision History	Date
-001	First release of the Intel® Desktop Board D850GB Technical Product Specification	September 2000

This product specification applies to only standard D850GB boards with BIOS identifier GB85010A.86A.

Changes to this specification will be published in the Intel Desktop Board D850GB Specification Update before being incorporated into a revision of this document.

Information in this document is provided in connection with Intel® products. No license, express or implied, by estoppel or otherwise, to any intellectual property rights is granted by this document. Except as provided in Intel's Terms and Conditions of Sale for such products, Intel assumes no liability whatsoever, and Intel disclaims any express or implied warranty, relating to sale and/or use of Intel products including liability or warranties relating to fitness for a particular purpose, merchantability, or infringement of any patent, copyright or other intellectual property right. Intel products are not intended for use in medical, life saving, or life sustaining applications.

Intel may make changes to specifications and product descriptions at any time, without notice.

The Intel® Desktop Board D850GB may contain design defects or errors known as errata that may cause the product to deviate from published specifications. Current characterized errata are available on request.

Contact your local Intel sales office or your distributor to obtain the latest specifications before placing your product order.

Copies of documents which have an ordering number and are referenced in this document, or other Intel literature, may be obtained from:

Intel Corporation  
P.O. Box 5937  
Denver, CO 80217-9808

or call in North America 1-800-548-4725, Europe 44-0-1793-431-155, France 44-0-1793-421-777,  
Germany 44-0-1793-421-333, other Countries 708-296-9333.

† Third-party brands and names are the property of their respective owners.

Copyright © 2000, Intel Corporation. All rights reserved.

# Preface

---

This Technical Product Specification (TPS) specifies the board layout, components, connectors, power and environmental requirements, and the BIOS for the Intel Desktop Board D850GB. It describes the standard product and available manufacturing options.

## Intended Audience

The TPS is intended to provide detailed, technical information about the D850GB board and its components to the vendors, system integrators, and other engineers and technicians who need this level of information. It is specifically *not* intended for general audiences.

## What This Document Contains

Chapter	Description
1	A description of the hardware used on the D850GB board
2	A map of the resources of the board
3	The features supported by the BIOS Setup program
4	The contents of the BIOS Setup program's menus and submenus
5	A description of the BIOS error messages, beep codes, POST codes, and diagnostic LEDs

## Typographical Conventions

This section contains information about the conventions used in this specification. Not all of these symbols and abbreviations appear in all specifications of this type.

## Notes, Cautions, and Warnings

### ⇒ NOTE

*Notes call attention to important information.*



### CAUTION

*Cautions are included to help you avoid damaging hardware or losing data.*



### WARNING

*Warnings indicate conditions, which if not observed, can cause personal injury.*

## Other Common Notation

#	Used after a signal name to identify an active-low signal (such as USBP0#)
(NxnX)	When used in the description of a component, N indicates component type, xn are the relative coordinates of its location on the D850GB board, and X is the instance of the particular part at that general location. For example, J5J1 is a connector, located at 5J. It is the first connector in the 5J area.
GB	Gigabyte (1,073,741,824 bytes)
GB/sec	Gigabytes per second
KB	Kilobyte (1024 bytes)
Kbit	Kilobit (1024 bits)
kbits/sec	1000 bits per second
MB	Megabyte (1,048,576 bytes)
MB/sec	Megabytes per second
Mbit	Megabit (1,048,576 bits)
Mbit/sec	Megabits per second
xxh	An address or data value ending with a lowercase h indicates a hexadecimal value.
x.x V	Volts. Voltages are DC unless otherwise specified.
†	This symbol is used to indicate third-party brands and names that are the property of their respective owners.

# Contents

---

## 1 Product Description

1.1	Overview .....	12
1.1.1	Feature Summary .....	12
1.1.2	Manufacturing Options .....	13
1.1.3	D850GB Board Layout .....	14
1.1.4	Block Diagram .....	15
1.2	Online Support .....	16
1.3	Design Specifications .....	16
1.4	Processor .....	19
1.5	System Memory .....	20
1.5.1	Memory Features .....	20
1.5.2	Continuity RIMM Modules .....	20
1.5.3	RDRAM Memory Configuration .....	21
1.6	Intel® 850 Chipset.....	22
1.6.1	AGP .....	23
1.6.2	USB.....	23
1.6.3	IDE Support .....	24
1.6.4	Real-Time Clock, CMOS SRAM, and Battery.....	25
1.6.5	Intel® 82802AB 4 Mbit Firmware Hub (FWH) .....	25
1.7	I/O Controller .....	26
1.7.1	Serial Port .....	26
1.7.2	Parallel Port.....	26
1.7.3	Diskette Drive Controller .....	27
1.7.4	Keyboard and Mouse Interface .....	27
1.8	Audio Subsystem (Optional) .....	28
1.8.1	Audio Connectors.....	29
1.8.2	Audio Subsystem Software .....	29
1.9	LAN Subsystem.....	30
1.9.1	Intel® 82562EM Platform LAN Connect Device (Optional).....	30
1.9.2	RJ-45 LAN Connector with Integrated LEDs (Optional).....	30
1.9.3	LAN Subsystem Software .....	31
1.10	CNR (Optional).....	31
1.11	Hardware Management Subsystem.....	32
1.11.1	Hardware Monitor Component .....	32
1.11.2	Fan Control and Monitoring.....	32
1.12	Power Management .....	33
1.12.1	Software Support .....	33
1.12.2	Hardware Support .....	37

## 2 Technical Reference

2.1	Introduction.....	43
2.2	Memory Map .....	43
2.3	I/O Map .....	44
2.4	DMA Channels .....	46
2.5	PCI Configuration Space Map .....	46
2.6	Interrupts .....	47
2.7	PCI Interrupt Routing Map .....	47
2.8	Connectors .....	49
2.8.1	Back Panel Connectors.....	50
2.8.2	Internal I/O Connectors .....	53
2.8.3	External I/O Connectors.....	65
2.9	Jumper Blocks.....	69
2.9.1	BIOS Setup Configuration Jumper Block.....	70
2.9.2	USB Port 2 Routing Jumper Block .....	70
2.10	Mechanical Considerations.....	71
2.10.1	Form Factor .....	71
2.10.2	I/O Shield .....	72
2.11	Electrical Considerations .....	73
2.11.1	Power Consumption.....	73
2.11.2	Add-in Board Considerations.....	73
2.11.3	Standby Current Requirements .....	74
2.11.4	Fan Connector Current Capability .....	75
2.11.5	Power Supply Considerations .....	75
2.12	Thermal Considerations.....	76
2.13	Reliability .....	77
2.14	Environmental .....	78
2.15	Regulatory Compliance .....	79
2.15.1	Safety Regulations .....	79
2.15.2	EMC Regulations .....	79
2.15.3	Certification Markings.....	80

## 3 Overview of BIOS Features

3.1	Introduction.....	81
3.2	BIOS Flash Memory Organization .....	82
3.3	Resource Configuration.....	82
3.3.1	PCI Autoconfiguration .....	82
3.3.2	PCI IDE Support.....	82
3.4	System Management BIOS (SMBIOS).....	83
3.5	USB Legacy Support.....	83
3.6	BIOS Updates .....	84
3.6.1	Language Support.....	84
3.6.2	Custom Splash Screen.....	85
3.7	Recovering BIOS Data .....	85

3.8	Boot Options.....	86
3.8.1	CD-ROM and Network Boot.....	86
3.8.2	Booting Without Attached Devices.....	86
3.9	Fast Booting Systems with Intel® Rapid BIOS Boot.....	86
3.9.1	Peripheral Selection and Configuration.....	86
3.9.2	Intel Rapid BIOS Boot.....	87
3.9.3	Operating System.....	87
3.10	BIOS Security Features.....	88
<b>4</b>	<b>BIOS Setup Program</b>	
4.1	Introduction.....	89
4.2	Maintenance Menu.....	90
4.2.1	Extended Configuration Submenu.....	91
4.3	Main Menu.....	92
4.4	Advanced Menu.....	93
4.4.1	PCI Configuration Submenu.....	94
4.4.2	Boot Configuration Submenu.....	95
4.4.3	Peripheral Configuration Submenu.....	96
4.4.4	IDE Configuration Submenu.....	98
4.4.5	Diskette Configuration Submenu.....	101
4.4.6	Event Log Configuration Submenu.....	102
4.4.7	Video Configuration Submenu.....	103
4.5	Security Menu.....	104
4.6	Power Menu.....	105
4.7	Boot Menu.....	106
4.8	Exit Menu.....	108
<b>5</b>	<b>Error Messages and Beep Codes</b>	
5.1	BIOS Error Messages.....	109
5.2	Port 80h POST Codes.....	111
5.3	Bus Initialization Checkpoints.....	115
5.4	Speaker.....	116
5.5	BIOS Beep Codes.....	116
5.6	Diagnostic LEDs.....	118
	<b>Figures</b>	
1.	D850GB Board Components.....	14
2.	Block Diagram.....	15
3.	Intel 850 Chipset Block Diagram.....	22
4.	Audio Subsystem Block Diagram.....	28
5.	ICH2 and CNR Signal Interface.....	31
6.	Using the Wake on LAN Technology Connector.....	39
7.	Location of the Standby Power Indicator LED.....	40
8.	Back Panel Connectors.....	50
9.	Audio Connectors.....	54
10.	Power and Hardware Control Connectors.....	56
11.	Add-in Board and Peripheral Interface Connectors.....	59
12.	External I/O Connectors.....	65

13. Location of the Jumper Blocks .....	69
14. D850GB Board Dimensions .....	71
15. I/O Shield Dimensions.....	72
16. Localized High Temperature Zones .....	76
17. Diagnostic LEDs .....	118

## Tables

1. Feature Summary .....	12
2. Manufacturing Options .....	13
3. Specifications.....	16
4. Supported Processors.....	19
5. Supported Memory Configurations.....	21
6. LAN Connector LED States.....	30
7. Effects of Pressing the Power Switch.....	34
8. Power States and Targeted System Power.....	35
9. Wake Up Devices and Events.....	36
10. Fan Connector Descriptions.....	38
11. System Memory Map .....	43
12. I/O Map.....	44
13. DMA Channels.....	46
14. PCI Configuration Space Map.....	46
15. Interrupts.....	47
16. PCI Interrupt Routing Map .....	48
17. PS/2 Mouse/Keyboard Connector .....	51
18. USB Connectors .....	51
19. Parallel Port Connector .....	51
20. Serial Port Connector.....	52
21. LAN Connector (optional).....	52
22. Audio Line In Connector (optional).....	52
23. Audio Line Out Connector (optional) .....	52
24. Mic In Connector (optional) .....	52
25. Auxiliary Line In Connector (J2C1).....	55
26. ATAPI CD-ROM Connector (J2D1) .....	55
27. CD-ROM Legacy Style Connector (J2D2).....	55
28. PC/PCI Connector (J6D1).....	55
29. ATX12V Power Connector (J3H1).....	57
30. Processor Voltage Regulator Fan Connector (J3M1) .....	57
31. RIMM Fan Connector (J7M2).....	57
32. Processor Fan Connector (J6L1) .....	57
33. Main Power Connector (J10K1) .....	57
34. Auxiliary Power (J9J1) .....	58
35. Wake On Ring Connector (J8C1).....	58
36. Wake on LAN Technology Connector (J7C1).....	58
37. Chassis Fan Connector (J10A2) .....	58
38. CNR Connector (J3A1) .....	60
39. PCI Bus Connectors (J4A1, J4B1, J4C1, J4D1, J4E1).....	61
40. AGP Connector (J5E1) .....	62

41. PCI IDE Connectors (J9G2, Primary and J9G1, Secondary) .....	63
42. Diskette Drive Connector (J10G1) .....	64
43. SCSI LED Connector (J7A2).....	66
44. Front Panel USB Connector (J9C1) .....	66
45. Auxiliary Front Panel Power/Sleep/Message Waiting LED Connector (J8C3) .....	66
46. Front Panel Connector (J9D2) .....	67
47. States for a One Color Power LED .....	67
48. States for a Two Color Power LED .....	68
49. BIOS Setup Configuration Jumper Settings (J8C2).....	70
50. USB Port 2 Routing Jumper Settings (J8D1).....	70
51. Power Usage .....	73
52. Standby Current Requirements.....	74
53. Thermal Considerations for Components.....	77
54. D850GB Board Environmental Specifications .....	78
55. Safety Regulations.....	79
56. EMC Regulations .....	79
57. Supervisor and User Password Functions.....	88
58. BIOS Setup Program Menu Bar .....	89
59. BIOS Setup Program Function Keys .....	90
60. Maintenance Menu .....	90
61. Extended Configuration Submenu.....	91
62. Main Menu .....	92
63. Advanced Menu .....	93
64. PCI Configuration Submenu.....	94
65. Boot Configuration Submenu .....	95
66. Peripheral Configuration Submenu .....	96
67. IDE Configuration Submenu.....	98
68. Primary/Secondary IDE Master/Slave Submenus .....	99
69. Diskette Configuration Submenu.....	101
70. Event Log Configuration Submenu.....	102
71. Video Configuration Submenu .....	103
72. Security Menu.....	104
73. Power Menu.....	105
74. Boot Menu .....	106
75. Exit Menu.....	108
76. BIOS Error Messages .....	109
77. Uncompressed INIT Code Checkpoints .....	111
78. Boot Block Recovery Code Checkpoints.....	111
79. Runtime Code Uncompressed in F000 Shadow RAM.....	112
80. Bus Initialization Checkpoints.....	115
81. Upper Nibble High Byte Functions .....	115
82. Lower Nibble High Byte Functions .....	116
83. Beep Codes .....	117
84. Diagnostic LED Codes .....	119



# 1 Product Description

---

## What This Chapter Contains

1.1	Overview .....	12
1.2	Online Support .....	16
1.3	Design Specifications .....	16
1.4	Processor .....	19
1.5	System Memory .....	20
1.6	Intel® 850 Chipset.....	22
1.7	I/O Controller .....	26
1.8	Audio Subsystem (Optional) .....	28
1.9	LAN Subsystem.....	30
1.10	CNR (Optional).....	31
1.11	Hardware Management Subsystem.....	32
1.12	Power Management .....	33

## 1.1 Overview

### 1.1.1 Feature Summary

Table 1 summarizes the D850GB board's major features.

**Table 1. Feature Summary**

<b>Form Factor</b>	ATX (12.0 inches by 9.6 inches)
<b>Processor</b>	<ul style="list-style-type: none"> <li>• Support for an Intel® Pentium® 4 processor</li> <li>• 400 MHz system data bus</li> </ul>
<b>Memory</b>	<ul style="list-style-type: none"> <li>• Two Direct-RDRAM channels with two RIMMs per channel (four RIMM sockets)</li> <li>• Support for up to 2 GB of system memory using PC600 or PC800 RDRAM</li> </ul>
<b>Chipset</b>	Intel® 850 Chipset, consisting of: <ul style="list-style-type: none"> <li>• Intel® 82850 Memory Controller Hub (MCH)</li> <li>• Intel® 82801BA I/O Controller Hub (ICH2)</li> <li>• Intel® 82802AB 4 Mbit Firmware Hub (FWH)</li> </ul>
<b>I/O Control</b>	SMSC LPC47M102 LPC bus I/O controller
<b>Video</b>	<ul style="list-style-type: none"> <li>• AGP connector supporting 1.5 V 4X AGP cards</li> </ul>
<b>Peripheral Interfaces</b>	<ul style="list-style-type: none"> <li>• Four Universal Serial Bus (USB) ports</li> <li>• One serial port</li> <li>• One parallel port</li> <li>• Two IDE interfaces with Ultra DMA, ATA-33/66/100 support</li> <li>• One diskette drive interface</li> <li>• PS/2<sup>†</sup> keyboard and mouse ports</li> </ul>
<b>Expansion Capabilities</b>	<ul style="list-style-type: none"> <li>• Five PCI bus add-in card connectors (SMBus routed to PCI bus connector 2)</li> </ul>
<b>BIOS</b>	<ul style="list-style-type: none"> <li>• Intel/AMI BIOS (resident in the Intel 82802AB 4 Mbit FWH)</li> <li>• Support for Advanced Power Management (APM), Advanced Configuration and Power Interface (ACPI), Plug and Play, and SMBIOS</li> </ul>
<b>Diagnostic LEDs</b>	Four dual-color LEDs on back panel
<b>Instantly Available PC</b>	<ul style="list-style-type: none"> <li>• Support for <i>PCI Local Bus Specification Revision 2.2</i></li> <li>• Suspend to RAM support</li> <li>• Wake on PCI, CNR, RS-232, front panel, PS/2 keyboard, and USB ports</li> </ul>
<b>Wake on LAN<sup>†</sup> Technology Connector</b>	Support for system wake up using an add-in network interface card with remote wake up capability
<b>Hardware Monitoring features</b>	Two fan sense inputs used to monitor fan activity
<b>Enhanced thermal monitor and fan control device</b>	<ul style="list-style-type: none"> <li>• Two additional fan sense inputs</li> <li>• Two additional thermal sense inputs</li> </ul>
<b>For information about</b>	<b>Refer to</b>
The board's compliance level with APM, ACPI, Plug and Play, and SMBIOS.	Section 1.3, page 16

## 1.1.2 Manufacturing Options

Table 2 describes the D850GB board's manufacturing options.

**Table 2. Manufacturing Options**

<b>Audio (Integrated)</b>	Audio subsystem that uses the Analog Devices AD1881 analog codec for AC 97 processing
<b>Video</b>	AGP Pro50 interface (50 W maximum); backward compatible with 1.5 V AGP video cards
<b>LAN</b>	Intel® 82562EM 10/100 Mbit/sec Platform LAN Connect (PLC) device
<b>Hardware Monitor Subsystem</b>	Heceta 4 Hardware Monitor: <ul style="list-style-type: none"> <li>• Voltage sense to detect out of range power supply voltages</li> <li>• Thermal sense to detect out of range thermal values</li> </ul>
<b>CNR</b>	One Communication and Networking Riser (CNR) connector (slot shared with PCI bus connector 5, J4A1)

### 1.1.3 D850GB Board Layout

Figure 1 shows the location of the major components on the D850GB board.

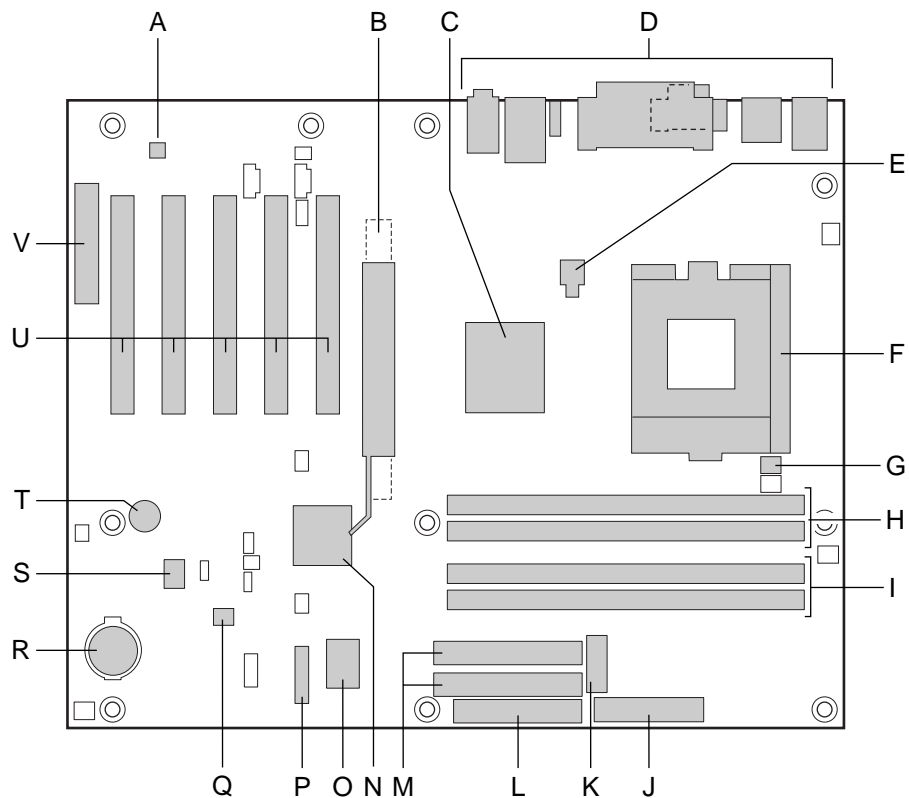

OM10441

- |   |  |   |   |
|---|--|---|---|
| A | AD1881 audio codec (optional)                | L | Diskette drive connector                                      |
| B | AGP connector (AGP Pro50 connector optional) | M | IDE connectors  |
| C | Intel 82850 Memory Controller Hub (MCH)      | N | Intel 82801BA I/O Controller Hub (ICH2)                       |
| D | Back panel connectors                        | O | SMSC LPC47M102 I/O Controller                                 |
| E | +12V power connector (ATX12V)                | P | Front panel connector   |
| F | Pentium 4 Processor socket                   | Q | Enhanced thermal monitor and fan control device               |
| G | Hardware monitor                             | R | Battery   |
| H | RAMBUS <sup>†</sup> Bank 0 (RIMM1 and RIMM2) | S | Intel 82802AB 4 Mbit Firmware Hub (FWH)                       |
| I | RAMBUS Bank 1 (RIMM3 and RIMM4)              | T | Speaker   |
| J | Power connector                              | U | PCI bus add-in card connectors                                |
| K | Auxiliary Power Connector                    | V | Communication and Networking Riser (CNR) connector (optional) |

**Figure 1. D850GB Board Components**

### 1.1.4 Block Diagram

Figure 2 is a block diagram of the major functional areas of the D850GB board.

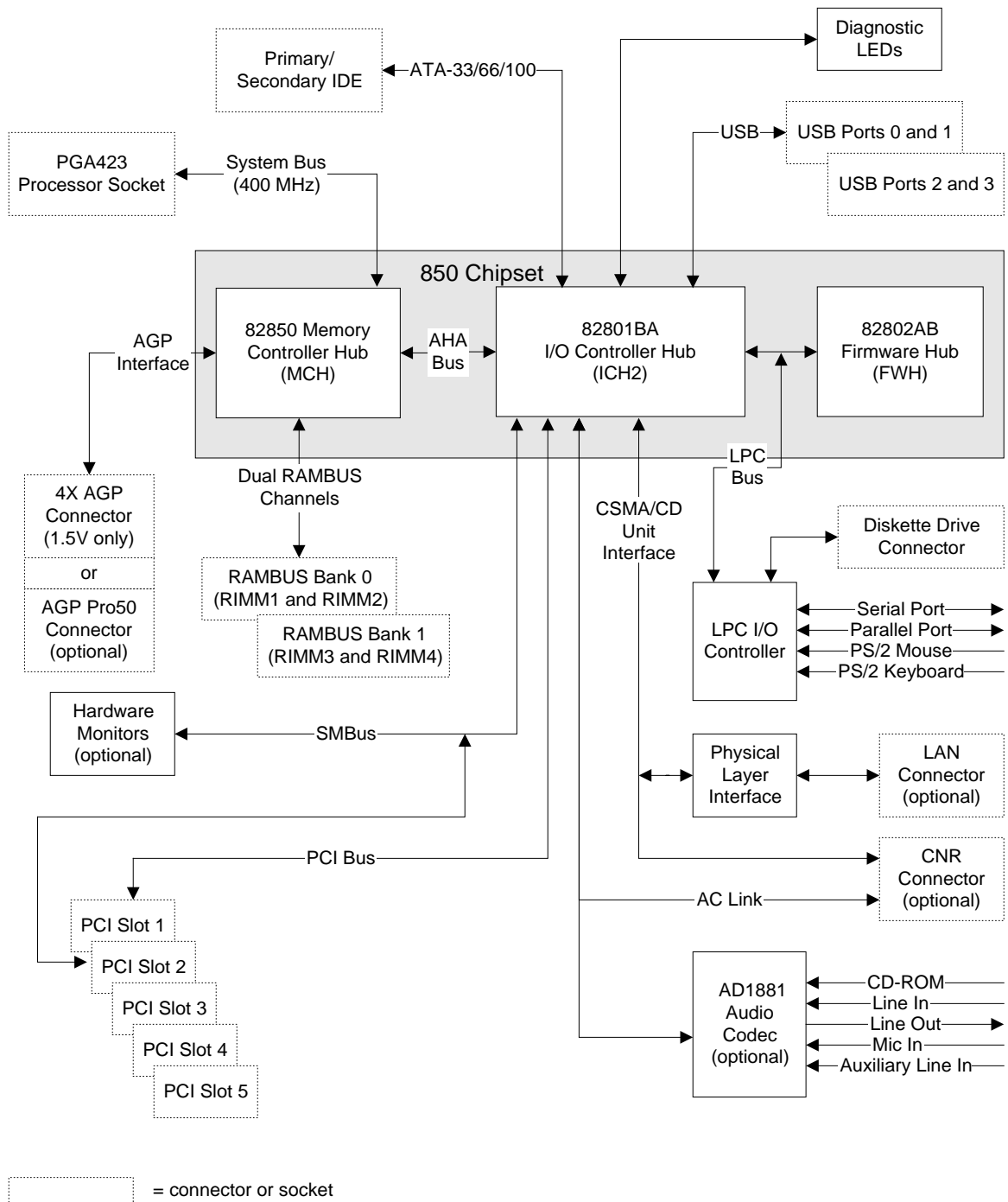

Figure 2. Block Diagram

## 1.2 Online Support

To find information about...	Visit this World Wide Web site:
Intel's D850GB board under "Product Info" or "Customer Support"	<a href="http://www.intel.com/design/motherbd">http://www.intel.com/design/motherbd</a> <a href="http://support.intel.com/support/motherboards/desktop">http://support.intel.com/support/motherboards/desktop</a>
Processor data sheets	<a href="http://www.intel.com/design/litcentr">http://www.intel.com/design/litcentr</a>
Proper date access in systems with Intel® motherboards	<a href="http://support.intel.com/support/year2000">http://support.intel.com/support/year2000</a>
ICH2 addressing	<a href="http://developer.intel.com/design/chipsets/datashts">http://developer.intel.com/design/chipsets/datashts</a>
Custom splash screens	<a href="http://intel.com/design/motherbd/gen_indx.htm">http://intel.com/design/motherbd/gen_indx.htm</a>
Audio software and utilities	<a href="http://www.intel.com/design/motherbd">http://www.intel.com/design/motherbd</a>
LAN software and drivers	<a href="http://www.intel.com/design/motherbd">http://www.intel.com/design/motherbd</a>

## 1.3 Design Specifications

Table 3 lists the specifications applicable to the D850GB board.

**Table 3. Specifications**

Reference Name	Specification Title	Version, Revision Date, and Ownership	The information is available from...
AC '97	<i>Audio Codec '97</i>	Version 2.1, May 1998, Intel Corporation	<a href="ftp://download.intel.com/pc-supp/platform/ac97">ftp://download.intel.com/pc-supp/platform/ac97</a>
ACPI	<i>Advanced Configuration and Power Interface Specification</i>	Version 2.0, July 27, 2000, Compaq Computer Corp., Intel Corporation, Microsoft Corporation, and Toshiba Corporation	<a href="http://www.teleport.com/~acpi/">http://www.teleport.com/~acpi/</a>
AGP	<i>Accelerated Graphics Port Interface Specification</i>	Version 2.0, May 4, 1998, Intel Corporation	the Accelerated Graphics Implementers Forum at: <a href="http://www.agpforum.org/">http://www.agpforum.org/</a>
AMI BIOS	<i>American Megatrends BIOS Specification</i>	AMIBIOS 99, 1999 American Megatrends, Inc.	<a href="http://www.amibios.com">http://www.amibios.com</a> , or <a href="http://www.ami.com/download/amibios99.pdf">http://www.ami.com/download/amibios99.pdf</a>
APM	<i>Advanced Power Management BIOS Interface Specification</i>	Version 1.2, February 1996, Intel Corporation, Microsoft Corporation	<a href="http://www.microsoft.com/hwdev/busbios/amp_12.htm">http://www.microsoft.com/hwdev/busbios/amp_12.htm</a>
ATA-3	<i>Information Technology - AT Attachment-3 Interface, X3T10/2008D</i>	Version 6, October 1995, ASC X3T10 Technical Committee	ATA Anonymous FTP Site: <a href="ftp://www.dt.wdc.com/ata/ata-3/">ftp://www.dt.wdc.com/ata/ata-3/</a>

continued

**Table 3. Specifications** (continued)

Reference Name	Specification Title	Version, Revision Date and Ownership	The information is available from...
ATAPI	<i>Information Technology AT Attachment with Packet Interface Extensions T13/1153D</i>	Version 18, August 19, 1998, Contact: T13 Chair, Seagate Technology	T13 Anonymous FTP Site: <a href="ftp://fission.dt.wdc.com/x3t13/project/d1153r18.pdf">ftp://fission.dt.wdc.com/x3t13/project/d1153r18.pdf</a>
ATX	<i>ATX Specification</i>	Version 2.01, February 1997, Intel Corporation	<a href="http://developer.intel.com/design/motherbd/atx.htm">http://developer.intel.com/design/motherbd/atx.htm</a>
ATX12V	<i>ATX / ATX12V Power Specification</i>	Version 1.1, August 2000, Intel Corporation	<a href="http://www.teleport.com/~ffsupprt/spec/ATX_ATX12V_PS_1_1.pdf">http://www.teleport.com/~ffsupprt/spec/ATX_ATX12V_PS_1_1.pdf</a>
BIS	<i>Boot Integrity Services</i>	Version 1.0 for WfM 2.0 August 1999, Intel Corporation	<a href="http://developer.intel.com/design/security/bis/bisfaq.htm">http://developer.intel.com/design/security/bis/bisfaq.htm</a>
CNR	<i>Communication and Network Riser (CNR) Specification</i>	Version 1.0, February 7, 2000, Intel Corporation	<a href="http://developer.intel.com/technology/cnr/index.htm">http://developer.intel.com/technology/cnr/index.htm</a>
EPP	<i>Enhanced Parallel Port IEEE std 1284.1-1997</i>	Version 1.7, 1997, Institute of Electrical and Electronic Engineers	<a href="http://standards.ieee.org/reading/ieee/std_public/description/busarch/1284.1-1997_desc.html">http://standards.ieee.org/reading/ieee/std_public/description/busarch/1284.1-1997_desc.html</a>
EI Torito	<i>Bootable CD-ROM format specification</i>	Version 1.0, January 25, 1995, Phoenix Technologies Ltd., and IBM Corporation	the Phoenix Web site at: <a href="http://www.ptltd.com/techs/specs.html">http://www.ptltd.com/techs/specs.html</a>
LPC	<i>Low Pin Count Interface Specification</i>	Version 1.0, September 29, 1997, Intel Corporation	<a href="http://www.intel.com/design/chipsets/industry/lpc.htm">http://www.intel.com/design/chipsets/industry/lpc.htm</a>
PCI	<i>PCI Local Bus Specification</i>	Version 2.2, December 18, 1998, PCI Special Interest Group	<a href="http://www.pcisig.com/">http://www.pcisig.com/</a>
	<i>PCI Bus Power Management Interface Specification</i>	Version 1.1, December 18, 1998, PCI Special Interest Group	<a href="http://www.pcisig.com/">http://www.pcisig.com/</a>
Plug and Play	<i>Plug and Play BIOS Specification</i>	Version 1.0a, May 5, 1994, Compaq Computer Corp., Phoenix Technologies Ltd., and Intel Corporation	<a href="http://www.microsoft.com/hwdev/respec/pnpspecs.htm">http://www.microsoft.com/hwdev/respec/pnpspecs.htm</a>
PXE	<i>Preboot Execution Environment</i>	Version 2.1, September 1999, Intel Corporation	<a href="http://developer.intel.com/ial/WfM/wfm20/design/mapxe/index.htm">http://developer.intel.com/ial/WfM/wfm20/design/mapxe/index.htm</a>

continued

**Table 3. Specifications** (continued)

<b>Reference Name</b>	<b>Specification Title</b>	<b>Version, Revision Date and Ownership</b>	<b>The information is available from...</b>
RIMM	<i>Rambus Serial Presence Detect (SPD) Specification</i>	Version 1.0, March 1999, Rambus Corp.	<a href="http://www.rambus.com/developer/support_rimm.html">http://www.rambus.com/developer/support_rimm.html</a>
	<i>Rambus RIMM Specification</i>	Version 1.0, February 1999, Rambus Corp.	<a href="http://www.rambus.com/developer/development_support.html">http://www.rambus.com/developer/development_support.html</a>
SMBIOS	<i>System Management BIOS</i>	Version 2.3, August 12, 1998, Award Software International Inc., Dell Computer Corporation, Hewlett-Packard Company, Intel Corporation, International Business Machines Corporation, Phoenix Technologies Limited, American Megatrends Inc., and SystemSoft Corporation	<a href="http://developer.intel.com/ial/wfm20/design/smbios">http://developer.intel.com/ial/wfm20/design/smbios</a>
UHCI	<i>Universal Host Controller Interface Design Guide</i>	Version 1.1, March 1996, Intel Corporation	<a href="http://www.usb.org/developers">http://www.usb.org/developers</a>
USB	<i>Universal Serial Bus Specification</i>	Version 1.1, September 23, 1998, Compaq Computer Corporation, Intel Corporation, Microsoft Corporation, and NEC	<a href="http://www.usb.org/developers">http://www.usb.org/developers</a>
WfM	<i>Wired for Management Baseline</i>	Version 2.0, December 18, 1998, Intel Corporation	<a href="http://developer.intel.com/ial/WfM/wfmspecs.htm">http://developer.intel.com/ial/WfM/wfmspecs.htm</a>

## 1.4 Processor



### CAUTION

*Use only the processors listed below. Use of unsupported processors can damage the D850GB board, the processor, and the power supply. See the Intel® Desktop Board 850GB Specification Update for the most up-to-date list of supported processors for the D850GB board.*

The D850GB board supports a single Pentium 4 processor with a system bus frequency of 400 MHz. The D850GB board supports the processors listed in Table 4.

**Table 4. Supported Processors**

Type	Designation	System Bus Frequency	L2 Cache Size
Pentium 4 processor	1.4 and 1.5 GHz	400 MHz	256 KB

All supported onboard memory can be cached, up to the cachability limit of the processor. See the processor's data sheet for cachability limits.

For information about	Refer to
Processor support	Section 1.2, page 16
Processor usage	Section 1.2, page 16

## 1.5 System Memory



### CAUTION

*Before installing or removing RIMM modules, remove AC power by unplugging the power cord from the computer. Failure to do so could damage the memory and the D850GB board. (After removing AC power the standby power indicator LED should not be lit. See Figure 7 on page 40 for the location of the standby power indicator LED.)*



### CAUTION

*The board supports combinations of no more than 32 RDRAM components per RDRAM channel. If the total number of RDRAM components installed in all RIMM sockets exceeds 64, the computer will not boot.*

### 1.5.1 Memory Features

The 82850 Memory Controller Hub integrates two lock-stepped Direct Rambus channels, providing a processor-to-memory bandwidth up to 3.2 GB/sec. The D850GB board has four RIMM sockets (two sockets for each channel) and supports the following memory features:

- Single- or double-sided RIMM configurations
- Maximum of 32 Direct Rambus devices per channel
- Memory configurations from 128 MB (minimum) to 2 GB (maximum) utilizing 128 Mbit or 256 Mbit technology PC600 or PC800 compliant RDRAM
- Serial Presence Detect (SPD) based configuration for optimal memory operation
- Suspend to RAM support
- ECC and non-ECC support

### 1.5.2 Continuity RIMM Modules

All RIMM sockets must be populated to achieve continuity for termination at the Rambus interface. Continuity RIMMs (or “pass-through” modules) must be installed in the second RDRAM channel if memory is not installed.

### 1.5.3 RDRAM Memory Configuration

When installing memory, note the following:

- The four RIMM sockets are grouped into two banks:
  - Bank 0 (labeled on the board as RIMM1 and RIMM2)
  - Bank 1 (labeled on the board as RIMM3 and RIMM4)
- Bank 0 must be populated first ensuring that the RDRAM installed in RIMM1 and RIMM2 is identical in speed, size, and density. For example, the minimum system configuration would use two 64 MB RIMM modules of PC600 or PC800 RDRAM.
- If the desired memory configuration has been achieved by populating Bank 0, then Bank 1 should be filled with two Continuity RIMMs.
- If memory is to be installed in Bank 1, the RIMM modules installed in RIMM3 and RIMM4 must be identical in size and density to each other, and match the speed of the RIMM modules in Bank 0. The RIMM modules do not, however, need to match those in Bank 0 in size and density. For example, if Bank 0 has two 128 MB RIMMs of PC800 RDRAM, Bank 1 would require PC800 RDRAM also, however, any other supported RIMM modules such as 64 MB or 192 MB could be used.
- If ECC functionality is required, all installed RIMM modules must be ECC-compliant

Table 5 gives examples of RDRAM component density for various RIMM modules. Component density (counts) can be identified on the RIMM label.

**Table 5. Supported Memory Configurations**

<b>Rambus Technology</b>	<b>Capacity with 4 DRAM Components per RIMM</b>	<b>Capacity with 6 DRAM Components per RIMM</b>	<b>Capacity with 8 DRAM Components per RIMM</b>	<b>Capacity with 12 DRAM Components per RIMM</b>	<b>Capacity with 16 DRAM Components per RIMM</b>
128/144 Mbit	64 MB	96 MB	128 MB	192 MB	256 MB
256/288 Mbit	128 MB	192 MB	256 MB	384 MB	512 MB

## 1.6 Intel® 850 Chipset

The Intel 850 chipset consists of the following devices:

- 82850 Memory Controller Hub (MCH) with Accelerated Hub Architecture (AHA) bus
- 82801BA I/O Controller Hub (ICH2) with AHA bus
- 82802AB Firmware Hub (FWH)

The MCH is a centralized controller for the system bus, the memory bus, the AGP bus, and the Accelerated Hub Architecture interface. The ICH2 is a centralized controller for the board's I/O paths. The FWH provides the nonvolatile storage of the BIOS. The component combination provides the chipset interfaces as shown in Figure 3.

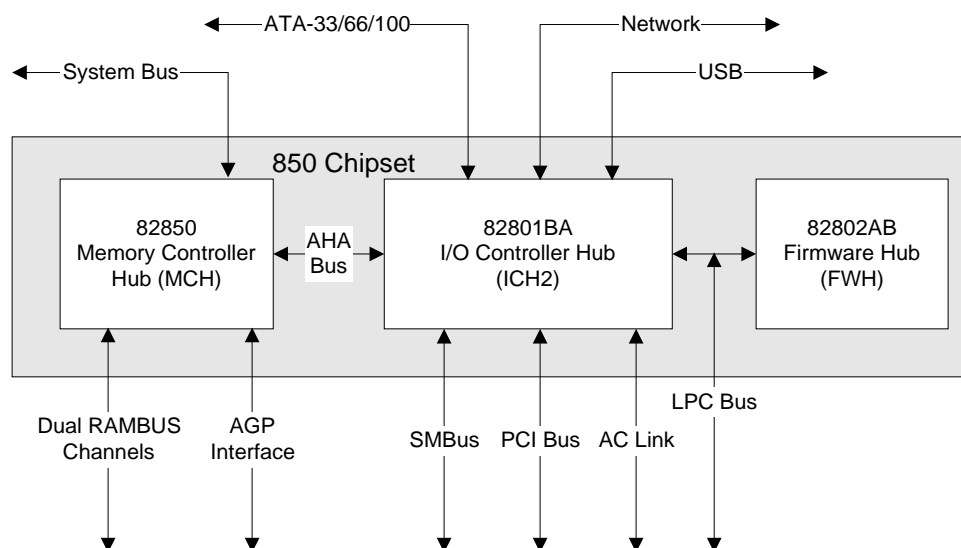

OM10411

**Figure 3. Intel 850 Chipset Block Diagram**

For information about	Refer to
The Intel 850 chipset	<a href="http://developer.intel.com">http://developer.intel.com</a>
Chipset resources	Section 1.3, page 16

## 1.6.1 AGP

The AGP connector supports AGP add-in cards with 1.5 V Switching Voltage Level (SVL). An AGP Pro50 interface is available (for a 50 W maximum power draw) as a manufacturing option. Legacy 3.3 V AGP cards are not supported and will prevent the system from booting if installed.

For information about	Refer to
The location of the AGP connector	Figure 1, page 14
The signal names of the AGP connector	Table 40, page 62

AGP is a high-performance interface for graphics-intensive applications, such as 3D applications. While based on the *PCI Local Bus Specification*, Rev. 2.1, AGP is independent of the PCI bus and is intended for exclusive use with graphical display devices. AGP overcomes certain limitations of the PCI bus related to handling large amounts of graphics data with the following features:

- Pipelined memory read and write operations that hide memory access latency
- Demultiplexing of address and data on the bus for nearly 100 percent efficiency

For information about	Refer to
Obtaining the <i>Accelerated Graphics Port Interface Specification</i>	Section 1.3, page 16

## 1.6.2 USB

The ICH2 contains two separate USB controllers supporting four USB ports. One USB peripheral can be connected to each port. For more than four USB devices, an external hub can be connected to any of the ports. Two of the USB ports are implemented with stacked back panel connectors. The other two are accessible via the front panel USB connector at location J9C1. One of the front panel USB connectors can be routed to the optional CNR connector. The D850GB board fully supports UHCI and uses UHCI-compatible software drivers.

### ⇒ NOTE

*Computer systems that have an unshielded cable attached to a USB port may not meet FCC Class B requirements, even if no device is attached to the cable. Use shielded cable that meets the requirements for full-speed devices.*

For information about	Refer to
The location of the USB connectors on the back panel	Figure 8, page 50
The signal names of the back panel USB connectors	Table 18, page 51
The location of the front panel USB connector	Figure 12, page 65
The signal names of the front panel USB connector	Table 44, page 66
The USB specification and UHCI	Section 1.3, page 16

## 1.6.3 IDE Support

### 1.6.3.1 IDE Interfaces

The ICH2's IDE controller has two independent bus-mastering IDE interfaces that can be independently enabled. The IDE interfaces support the following modes:

- Programmed I/O (PIO): processor controls data transfer.
- 8237-style DMA: DMA offloads the processor, supporting transfer rates of up to 16 MB/sec.
- Ultra DMA: DMA protocol on IDE bus supporting host and target throttling and transfer rates of up to 33 MB/sec.
- Ultra ATA-66: DMA protocol on IDE bus supporting host and target throttling and transfer rates of up to 66 MB/sec. ATA-66 protocol is similar to Ultra DMA and is device driver compatible.
- Ultra ATA-100: DMA protocol on IDE bus allows host and target throttling. The ICH2 Ultra ATA-100 logic can achieve read transfer rates up to 100 MB/sec and write transfer rates up to 88 MB/sec.

#### ⇒ NOTE

*ATA-66 uses faster timings and requires a specialized cable to reduce reflections, noise, and inductive coupling. The higher quality cable that supports ATA-66 DMA also supports ATA-100 DMA operation and is required for top performance from ATA-100 devices.*

The IDE interfaces also support ATAPI devices (such as CD-ROM drives) and ATA devices using the transfer modes listed in Section 4.4.4.1 on page 99.

The BIOS supports logical block addressing (LBA) and extended cylinder head sector (ECHS) translation modes. The drive reports the transfer rate and translation mode to the BIOS.

The D850GB board supports laser servo (LS-120) diskette technology through its IDE interfaces. An LS-120 drive can be configured as a boot device by setting the BIOS Setup program's Boot menu to one of the following:

- ARMD-FDD (ATAPI removable media device – floppy disk drive)
- ARMD-HDD (ATAPI removable media device – hard disk drive)

For information about	Refer to
The location of the IDE connectors	Figure 11, page 59
The signal names of the IDE connectors	Table 41, page 63
BIOS Setup program's Boot menu	Table 74, page 106

### 1.6.3.2 SCSI Hard Drive Activity LED Connector

The SCSI hard drive activity LED connector is a 1 x 2-pin connector that allows an add-in SCSI controller to use the same LED as the onboard IDE controller. For proper operation, this connector should be wired to the LED output of the add-in SCSI controller. The LED indicates when data is being read from, or written to, both the add-in SCSI controller and the IDE controller.

For information about	Refer to
The location of the SCSI hard drive activity LED connector	Figure 12, page 65
The signal names of the SCSI hard drive activity LED connector	Table 43, page 66

### 1.6.4 Real-Time Clock, CMOS SRAM, and Battery

The real-time clock provides a time-of-day clock and a multicentury calendar with alarm features. The real-time clock supports 256 bytes of battery-backed CMOS SRAM in two banks that are reserved for BIOS use.

A coin-cell battery (CR2032) powers the real-time clock and CMOS memory. When the computer is not plugged into a wall socket, the battery has an estimated life of three years. When the computer is plugged in, the standby current from the power supply extends the life of the battery. The clock is accurate to  $\pm 13$  minutes/year at 25 °C with 3.3 VSB applied.

The time, date, and CMOS values can be specified in the BIOS Setup program. The CMOS values can be returned to their defaults by using the BIOS Setup program.

#### ⇒ NOTE

*If the battery and AC power fail, custom defaults, if previously saved, will be loaded into CMOS RAM at power-on.*

#### ⇒ NOTE

*The recommended method of accessing the date in systems with D850GB boards is indirectly from the Real-Time Clock (RTC) via the BIOS. The BIOS on D850GB boards contains a century checking and maintenance feature. This feature checks the two least significant digits of the year stored in the RTC during each BIOS request (INT 1Ah) to read the date and, if less than 80 (i.e., 1980 is the first year supported by the PC), updates the century byte to 20. This feature enables operating systems and applications using the BIOS date/time services to reliably manipulate the year as a four-digit value.*

For information about	Refer to
Proper date access in systems with D850GB boards	Section 1.2, page 16

### 1.6.5 Intel® 82802AB 4 Mbit Firmware Hub (FWH)

The FWH provides the following:

- System BIOS program
- System security and manageability logic that enables protection for storing and updating of platform information

## 1.7 I/O Controller

The SMSC LPC47M102 I/O controller provides the following features:

- 3.3 V operation
- One serial port
- One parallel port with Extended Capabilities Port (ECP) and Enhanced Parallel Port (EPP) support
- Serial IRQ interface compatible with serialized IRQ support for PCI systems
- PS/2-style mouse and keyboard interfaces
- Interface for one 1.2 MB or 1.44 MB diskette drive
- Intelligent power management, including a programmable wake up event interface
- PCI power management support
- One fan tachometer input

The BIOS Setup program provides configuration options for the I/O controller.

For information about	Refer to
SMSC LPC47M102 I/O controller	<a href="http://www.smisc.com">http://www.smisc.com</a>

### 1.7.1 Serial Port

The D850GB board has one serial port connector on the back panel. The serial port's NS16C550-compatible UARTs support data transfers at speeds up to 115.2 kbits/sec with BIOS support. The serial port can be assigned as COM1 (3F8h), COM2 (2F8h), COM3 (3E8h), or COM4 (2E8h).

For information about	Refer to
The location of the serial port connector	Figure 8, page 50
The signal names of the serial port connector	Table 20, page 52

### 1.7.2 Parallel Port

The connector for the multimode bidirectional parallel port is a 25-pin D-Sub connector located on the back panel. In the BIOS Setup program, the parallel port can be configured for the following:

- Output only (PC AT<sup>+</sup>-compatible mode)
- Bi-directional (PS/2 compatible)
- EPP
- ECP

For information about	Refer to
The location of the parallel port connector	Figure 8, page 50
The signal names of the parallel port connector	Table 19, page 51

### 1.7.3 Diskette Drive Controller

The I/O controller supports one diskette drive that is compatible with the 82077 diskette drive controller and supports both PC-AT and PS/2 modes.

For information about	Refer to
The location of the diskette drive connector	Figure 11, page 59
The signal names of the diskette drive connector	Table 42, page 64
The supported diskette drive capacities and sizes	Table 69, page 101

### 1.7.4 Keyboard and Mouse Interface

PS/2 keyboard and mouse connectors are located on the back panel. The +5 V lines to these connectors are protected with a PolySwitch<sup>†</sup> circuit that, like a self-healing fuse, reestablishes the connection after an overcurrent condition is removed.

#### ⇒ NOTE

*The keyboard is supported in the bottom PS/2 connector and the mouse is supported in the top PS/2 connector. Power to the computer should be turned off before a keyboard or mouse is connected or disconnected.*

The keyboard controller contains the AMI keyboard and mouse controller code, provides the keyboard and mouse control functions, and supports password protection for power-on/reset. A power-on/reset password can be specified in the BIOS Setup program.

For information about	Refer to
The location of the keyboard and mouse connectors	Figure 8, page 50
The signal names of the keyboard and mouse connectors	Table 17, page 51

## 1.8 Audio Subsystem (Optional)



### CAUTION

The pins on both the legacy-style 2-mm and the ATAPI CD-ROM connectors are wired to the same inputs on the audio mixer. Do not attach CD-ROM drives to both connectors, otherwise, the board or drives could be damaged.

The audio subsystem includes these features:

- Split digital/analog architecture for improved S/N (signal-to-noise) ratio:  $\geq 85$  dB
- Power management support for APM 1.2 and ACPI 1.0 (driver dependant)
- 3-D stereo enhancement

Even though all connectors may not appear on all boards, the audio subsystem supports the following audio interfaces:

- CD-ROM (legacy-style 2-mm connector)
- ATAPI-style connectors:
  - CD-ROM
  - Auxiliary line in
- Back panel audio connectors:
  - Line out
  - Line in
  - Mic in

The audio subsystem consists of the following devices:

- Intel 82801BA I/O Controller Hub (ICH2)
- Analog Devices AD1881 analog codec

Figure 4 is a block diagram of the audio subsystem.

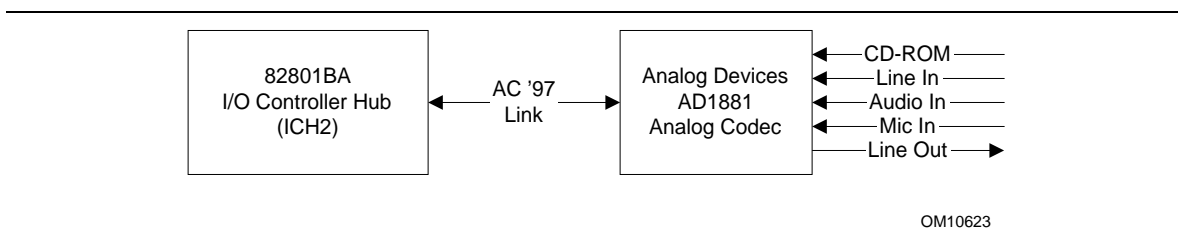

**Figure 4. Audio Subsystem Block Diagram**

#### For information about

The back panel audio connectors

#### Refer to

Section 2.8.1, page 50

## 1.8.1 Audio Connectors

### 1.8.1.1 CD-ROM (Legacy-style 2-mm) Audio Connector

A 1 x 4-pin legacy-style 2-mm connector connects an internal CD-ROM drive to the audio mixer.

For information about	Refer to
The location of the legacy-style 2-mm connector	Figure 9, page 54
The signal names of the legacy-style 2-mm connector	Table 38, page 57

### 1.8.1.2 ATAPI CD-ROM Audio Connector

A 1 x 4-pin ATAPI-style connector connects an internal ATAPI CD-ROM drive to the audio mixer.

For information about	Refer to
The location of the ATAPI CD-ROM connector	Figure 9, page 54
The signal names of the ATAPI CD-ROM connector	Table 26, page 55

### 1.8.1.3 Auxiliary Line In Connector

A 1 x 4-pin ATAPI-style connector connects the left and right channel signals of an internal audio device to the audio subsystem.

For information about	Refer to
The location of the auxiliary line in connector	Figure 9, page 54
The signal names of the auxiliary line in connector	Table 25, page 55

## 1.8.2 Audio Subsystem Software

Audio software and drivers are available from Intel's World Wide Web site.

For information about	Refer to
Obtaining audio software and drivers	Section 1.2, page 16

## 1.9 LAN Subsystem

The Network Interface Controller subsystem consists of the ICH2 (with integrated LAN Media Access Controller) and a physical layer interface device. Features of the LAN subsystem include:

- PCI Bus Master interface
- CSMA/CD Protocol Engine
- Serial CSMA/CD unit interface that supports the following physical layer interface devices:
  - 82562EM onboard LAN
  - 82562ET/EM (10/100 Mbit/sec Ethernet) on CNR bus
  - 82562EH (1 Mbit/sec HomePNA<sup>†</sup>) on CNR bus
- PCI Power Management
  - Supports APM
  - Supports ACPI technology
  - Supports Wake up from suspend state (Wake on LAN<sup>†</sup> technology)

### 1.9.1 Intel<sup>®</sup> 82562EM Platform LAN Connect Device (Optional)

The Intel 82562EM component provides an interface to the back panel RJ-45 connector with integrated LEDs. This physical interface may alternately be provided via the CNR connector.

The Intel 82562EM provides the following functions:

- Basic 10/100 Ethernet LAN connectivity
- Supports RJ-45 connector with status indicator LEDs on the back panel
- Full device driver compatibility
- Advanced Power Management and ACPI support
- Programmable transit threshold
- Configuration EEPROM that contains the MAC address
- Remote monitoring (alerting)

### 1.9.2 RJ-45 LAN Connector with Integrated LEDs (Optional)

Two LEDs are built into the RJ-45 LAN connector. Table 6 describes the LED states when the board is powered up and the LAN subsystem is operating.

**Table 6. LAN Connector LED States**

LED Color	LED State	Condition
Green	Off	10 Mbit/sec data rate is selected.
	On	100 Mbit/sec data rate is selected.
Yellow	Off	LAN link is not established.
	On (steady state)	LAN link is established.
	On (brighter and pulsing)	The computer is communicating with another computer on the LAN.

### 1.9.3 LAN Subsystem Software

LAN software and drivers are available from Intel's World Wide Web site.

For information about	Refer to
Obtaining LAN software and drivers	Section 1.2, page 16

### 1.10 CNR (Optional)

The CNR connector provides an interface that supports the audio, modem, USB, and LAN interfaces of the Intel 850 chipset. Figure 5 shows the signal interface between the riser and the ICH2.

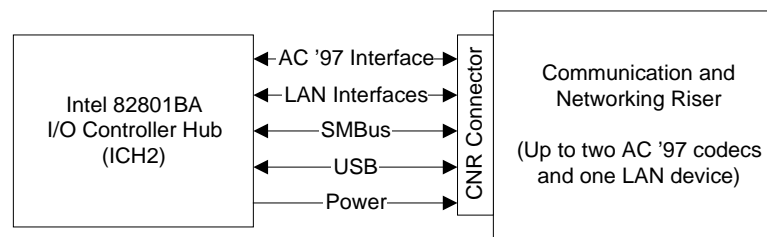

OM10412

**Figure 5. ICH2 and CNR Signal Interface**

The interfaces supported by the CNR include the following:

- AC '97 interface: supports audio and/or modem functions on the CNR board.
- LAN interfaces: provides one of two LAN interfaces for networking functions. Interfaces include an eight-pin interface for use with Platform LAN Connection (PLC) based devices, and a 17-pin interface for Media Independent Interface (MII) based devices (commonly referred to as a PHY).
- SMBus interface: provides Plug-and-Play functionality for the CNR board.
- USB interface: provides a USB interface for the CNR board.

The CNR connector includes power signals required for power management and for CNR board operation. To learn more about the CNR, refer to the CNR specification.

For information about	Refer to
Obtaining the CNR specification	Section 1.3, page 16



#### **CAUTION**

*Do not install a LAN CNR board if the D850GB already has onboard LAN subsystem. Doing so could prevent the board from connecting to the LAN.*

## 1.11 Hardware Management Subsystem

The hardware management features enable the board to be compatible with the Wired for Management (WfM) specification. The board has several hardware management features, including the following:

- Fan control and monitoring
- Thermal and voltage monitoring

For information about	Refer to
The WfM specification	Table 3, page 16

### 1.11.1 Hardware Monitor Component

The hardware monitor component provides low-cost instrumentation capabilities. The features of the component include:

- Internal ambient temperature sensing
- Remote thermal diode sensing for direct monitoring of processor temperature
- Power supply monitoring (+12, +5, +3.3, +2.5, 3.3 VSB, Vccp) to detect levels above or below acceptable values
- SMBus interface

### 1.11.2 Fan Control and Monitoring

The SMSC LPC47M102 I/O controller provides one fan tachometer input. The enhanced thermal monitor and fan control device provides two fan sense inputs and two fan control outputs. Monitoring and control can be implemented using third-party software.

For information about	Refer to
The functions of the fan connectors	Section 1.12.2.2, page 38
The location of the fan connectors	Figure 10, page 56
The signal names of the fan connectors	Section 2.8.2.2, page 54

## 1.12 Power Management

Power management is implemented at several levels, including:

- Software support:
  - Advanced Power Management (APM)
  - Advanced Configuration and Power Interface (ACPI)
- Hardware support:
  - Power connector
  - Fan connectors
  - Wake on LAN technology
  - Instantly Available technology
  - Resume on Ring
  - Wake from USB
  - Wake from PS/2 keyboard
  - PME# wakeup support

### 1.12.1 Software Support

The software support for power management includes:

- APM
- ACPI

If an ACPI-aware operating system is used, the BIOS can provide ACPI support. Otherwise, it defaults to APM support.

#### 1.12.1.1 APM

APM makes it possible for the computer to enter an energy-saving standby mode. The standby mode can be initiated in the following ways:

- Time-out period specified in the BIOS Setup program
- From the operating system, such as the Standby menu item in Windows<sup>†</sup> 98

In standby mode, the D850GB board can reduce power consumption by spinning down hard drives, and reducing power to, or turning off of, VESA<sup>†</sup> DPMS-compliant monitors. Power management mode can be enabled or disabled in the BIOS Setup program.

While in standby mode, the system retains the ability to respond to external interrupts and service requests, such as incoming faxes or network messages. Any keyboard or mouse activity brings the system out of standby mode and immediately restores power to the monitor.

The BIOS enables APM by default, but the operating system must support an APM driver for the power management features to work. For example, Windows 98 supports the power management features upon detecting that APM is enabled in the BIOS.

For information about	Refer to
Enabling or disabling power management in the BIOS Setup program	Table 73, page 105
The D850GB board's compliance level with APM	Table 3, page 16

### 1.12.1.2 ACPI

ACPI gives the operating system direct control over the power management and Plug and Play functions of a computer. The use of ACPI with the D850GB board requires an operating system that provides full ACPI support. ACPI features include:

- Plug and Play (including bus and device enumeration) and APM support (normally contained in the BIOS)
- Power management control of individual devices, add-in boards (some add-in boards may require an ACPI-aware driver), video displays, and hard disk drives
- Methods for achieving less than 15-watt system operation in the power-on/standby sleeping state
- A Soft-off feature that enables the operating system to power-off the computer
- Support for multiple wake up events (see Table 9 on page 36)
- Support for a front panel power and sleep mode switch. Table 7 lists the system states based on how long the power switch is pressed, depending on how ACPI is configured with an ACPI-aware operating system.

**Table 7. Effects of Pressing the Power Switch**

If the system is in this state...	...and the power switch is pressed for	...the system enters this state
Off (ACPI G2/G5 – Soft off)	Less than four seconds	Power-on (ACPI G0 – working state)
On (ACPI G0 – working state)	Less than four seconds	Soft-off/Standby (ACPI G1 – sleeping state)
On (ACPI G0 – working state)	More than four seconds	Fail safe power-off (ACPI G2/G5 – Soft off)
Sleep (ACPI G1 – sleeping state)	Less than four seconds	Wake up (ACPI G0 – working state)
Sleep (ACPI G1 – sleeping state)	More than four seconds	Power-off (ACPI G2/G5 – Soft off)

For information about	Refer to
The D850GB board's compliance level with ACPI	Section 1.3, page 16

### 1.12.1.2.1 System States and Power States

Under ACPI, the operating system directs all system and device power state transitions. The operating system puts devices in and out of low-power states based on user preferences and knowledge of how devices are being used by applications. Devices that are not being used can be turned off. The operating system uses information from applications and user settings to put the system as a whole into a low-power state.

Table 8 lists the power states supported by the D850GB board along with the associated system power targets. See the ACPI specification for a complete description of the various system and power states.

**Table 8. Power States and Targeted System Power**

Global States	Sleeping States	Processor States	Device States	Targeted System Power <sup>(Note 1)</sup>
G0 – working state	S0 – working	C0 – working	D0 – working state.	Full power > 30 W
G1 – sleeping state	S1 – Processor stopped	C1 – stop grant	D1, D2, D3 – device specification specific.	5 W < power < 52.5 W
G1 – sleeping state	S3 – Suspend to RAM. Context saved to RAM.	No power	D3 – no power except for wake up logic.	Power < 5 W <sup>(Note 2)</sup>
G2/S5	S5 – Soft off. Context not saved. Cold boot is required.	No power	D3 – no power except for wake up logic.	Power < 5 W <sup>(Note 2)</sup>
G3 – mechanical off AC power is disconnected from the computer.	No power to the system.	No power	D3 – no power for wake up logic, except when provided by battery or external source.	No power to the system so that service can be performed.

Notes:

1. Total system power is dependent on the system configuration, including add-in boards and peripherals powered by the system chassis' power supply.
2. Dependent on the standby power consumption of wake-up devices used in the system.

### 1.12.1.2.2 Wake Up Devices and Events

Table 9 lists the devices or specific events that can wake the computer from specific states.

**Table 9. Wake Up Devices and Events**

<b>These devices/events can wake up the computer...</b>	<b>...from this state</b>
Power switch	S1, S3, S4BIOS, S5
RTC alarm	S1, S3, S4BIOS
LAN	S1, S3
CNR	S1, S3, S5
PME#	S1, S3, S5
Modem (back panel Serial Port A)	S1, S3
IR command	S1
USB	S1, S3
PS/2 keyboard	S1, S3

#### ⇒ NOTE

*The use of these wake up events from an ACPI state requires a properly configured operating system that provides full ACPI support. In addition, software, drivers, and peripherals must fully support ACPI wake events.*

### 1.12.1.2.3 Plug and Play

In addition to power management, ACPI provides control information so that operating systems can facilitate Plug and Play. ACPI is used only to configure devices that do not use other hardware configuration standards. PCI devices for example, are not configured by ACPI.

## 1.12.2 Hardware Support



### CAUTION

*If the Wake on LAN and Instantly Available technology features are used, ensure that the power supply provides adequate +5 V standby current. Failure to do so can damage the power supply. The total amount of standby current required depends on the wake devices supported and manufacturing options. Refer to Section 2.11.3 on page 74 for additional information.*

The D850GB board provides several power management hardware features, including:

- Power connector
- Fan connectors
- Wake on LAN technology
- Instantly Available technology
- Resume on Ring
- Wake from USB
- Wake from PS/2 keyboard
- PME# wakeup support

Wake on LAN technology and Instantly Available technology require power from the +5 V standby line. The sections discussing these features describe the incremental standby power requirements for each.

Resume on Ring enables telephony devices to access the computer when it is in a power-managed state. The method used depends on the type of telephony device (external or internal) and the power management mode being used (APM or ACPI).

### ⇒ NOTE

*The use of Resume on Ring and Wake from USB technologies from an ACPI state requires an operating system that provides full ACPI support.*

#### 1.12.2.1 Power Connector

When used with an ATX12V-compliant power supply that supports remote power on/off, the D850GB board can turn off the system power through software control. To enable soft-off control in software, advanced power management must be enabled in the BIOS Setup program and in the operating system. When the system BIOS receives the correct APM command from the operating system, the BIOS turns off power to the computer.

With soft-off enabled, if power to the computer is interrupted by a power outage or a disconnected power cord, when power resumes, the computer returns to the power state it was in before power was interrupted (on or off). The computer's response can be set using the After Power Failure feature in the BIOS Setup program's Boot menu.

For information about	Refer to
The location of the power connector	Figure 10, page 56
The signal names of the power connector	Table 33, page 57
The BIOS Setup program's Boot menu	Table 74, page 106
The ATX specification	Section 1.3, page 16

### 1.12.2.2 Fan Connectors

Table 10 describes the functions of the four fan connectors.

**Table 10. Fan Connector Descriptions**

Connector	Function
Chassis fan (fan 1)	Provides +12 V DC for the system or chassis fan. The fan voltage can be switched on or off, depending on the power management state of the computer. A tachometer feedback connection is also provided. A fan attached to this connector can be monitored and controlled by the enhanced thermal monitor and fan control device.
RIMM fan (fan 2)	Provides +12 V DC for the fan to cool the RIMM modules. The fan voltage can be switched on or off, depending on the power management state of the computer. A tachometer feedback connection is also provided. A fan attached to this connector can be monitored and controlled by the enhanced thermal monitor and fan control device.
Processor fan (fan 3)	Provides +12 V DC for the processor fan or active fan heatsink. This fan is on in the S1 state and is off only when the system is off or in the S5 state. There are no user controls, however, this fan connector is wired to the fan tachometer input of the SMSC LPC47M102 I/O controller.
Processor voltage regulator fan (fan 4)	Provides +12 V DC for the fan to cool the processor voltage regulator area. This fan is on in the S1 state and is off only when the system is off or in the S5 state. There are no user controls.

For information about	Refer to
The location of the fan connectors	Figure 10, page 56
The signal names of the fan connectors	Section 2.8.2.2, page 54

### 1.12.2.3 Wake on LAN Technology



#### CAUTION

For Wake on LAN technology, the 5-V standby line for the power supply must be capable of providing adequate +5 V standby current. Failure to provide adequate standby current when implementing Wake on LAN technology can damage the power supply. Refer to Section 2.11.3 on page 74 for additional information.

Wake on LAN technology enables remote wakeup of the computer through a network. The LAN subsystem PCI bus network adapter monitors network traffic at the Media Independent Interface. Upon detecting a Magic Packet<sup>†</sup> frame, the LAN subsystem asserts a wakeup signal that powers up the computer. Depending on the LAN implementation, the D850GB board supports Wake on LAN technology in the following ways:

- With APM, through the Wake on LAN technology connector
- With ACPI,
  - through the PCI bus PME# signal for PCI 2.2 compliant LAN designs (ACPI S5 only)
  - through the onboard LAN subsystem
  - through a CNR-based LAN subsystem

The Wake on LAN technology connector can be used with PCI bus network adapters that have a remote wake up connector, as shown in Figure 6. Network adapters that are PCI 2.2 compliant assert the wakeup signal through the PCI bus signal PME# (pin A19 on the PCI bus connectors).

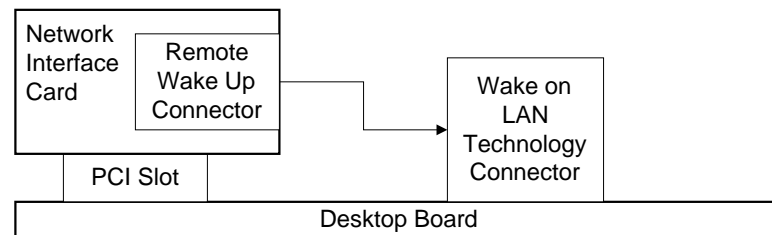

OM10731

**Figure 6. Using the Wake on LAN Technology Connector**

For information about	Refer to
The location of the Wake on LAN technology connector	Figure 10, page 56
The signal names of the Wake on LAN technology connector	Table 36, page 58

### 1.12.2.4 Instantly Available Technology



#### CAUTION

For Instantly Available technology, the 5-V standby line for the power supply must be capable of providing adequate +5 V standby current. Failure to provide adequate standby current when implementing Instantly Available technology can damage the power supply. Refer to Section 2.11.3 on page 74 for additional information.

Instantly Available technology enables the D850GB board to enter the ACPI S3 (Suspend-to-RAM) sleep-state. While in the S3 sleep-state, the computer will appear to be off (the power supply is off, and the front panel LED is amber if dual-color, or off if single-color.) When signaled by a wake-up device or event, the system quickly returns to its last known wake state. Table 9 on page 36 lists the devices and events that can wake the computer from the S3 state.

The D850GB board supports the *PCI Bus Power Management Interface Specification*. For information on the versions of this specification, see Section 1.3. Add-in boards that also support this specification can participate in power management and can be used to wake the computer.

The use of Instantly Available technology requires operating system support and PCI 2.2 compliant add-in cards and drivers.

The standby power indicator LED shows that power is still present at the RIMM, PCI bus, and CNR connectors, even when the computer appears to be off. Figure 7 shows the location of the standby power indicator LED.

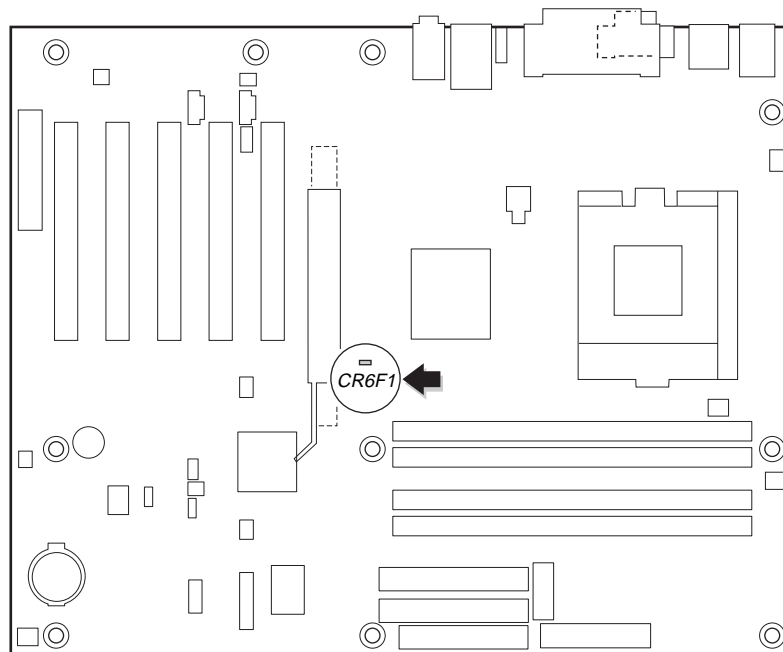

OM10442

**Figure 7. Location of the Standby Power Indicator LED**

### 1.12.2.5 Resume on Ring

The operation of Resume on Ring can be summarized as follows:

- Resumes operation from either the APM sleep mode or the ACPI S1 or S3 states
- Requires only one call to access the computer
- Detects incoming call similarly for external and internal modems
- Requires modem interrupt be unmasked for correct operation

### 1.12.2.6 Wake from USB

USB bus activity wakes the computer from an ACPI S1 or S3 state.

#### ⇒ NOTE

*Wake from USB requires the use of a USB peripheral that supports Wake from USB.*

### 1.12.2.7 Wake from PS/2 Keyboard

PS/2 keyboard activity wakes the computer from an ACPI S1 or S3 state.

### 1.12.2.8 PME# Wakeup Support

When the PME# signal on the PCI bus is asserted, the computer wakes from an ACPI S1, S3, or S5 state (with BIOS support).

### 1.12.2.9 Wake on LAN (Legacy)

This provision allows legacy internal LAN cards that require separate internal board connection to support Wake on LAN technology. (More recent PCI LAN cards use the PME# signal available at the PCI connector for this purpose.)

When a Wake on LAN technology supporting LAN card is connected to the Wake on LAN connector, LAN activity wakes the computer from the APM sleep mode, or the ACPI S1, S3, or S5 states.



## 2 Technical Reference

---

### What This Chapter Contains

2.1	Introduction.....	43
2.2	Memory Map .....	43
2.3	I/O Map .....	44
2.4	DMA Channels .....	46
2.5	PCI Configuration Space Map .....	46
2.6	Interrupts .....	47
2.7	PCI Interrupt Routing Map .....	47
2.8	Connectors .....	49
2.9	Jumper Blocks .....	69
2.10	Mechanical Considerations.....	71
2.11	Electrical Considerations .....	73
2.12	Thermal Considerations.....	76
2.13	Reliability .....	77
2.14	Environmental .....	78
2.15	Regulatory Compliance .....	79

### 2.1 Introduction

Sections 2.2 - 2.6 contain several standalone tables. Table 11 describes the system memory map, Table 12 shows the I/O map, Table 13 lists the DMA channels, Table 14 defines the PCI configuration space map, and Table 15 describes the interrupts. The remaining sections in this chapter are introduced by text found with their respective section headings.

### 2.2 Memory Map

**Table 11. System Memory Map**

Address Range (decimal)	Address Range (hex)	Size	Description
1024 K - 2097152 K	100000 - 7FFFFFFF	2047 MB	Extended memory
960 K - 1024 K	F0000 - FFFFF	64 KB	Runtime BIOS
896 K - 960 K	E0000 - EFFFF	64 KB	Reserved
800 K - 896 K	C8000 - DFFFF	96 KB	Available high DOS memory (open to the PCI bus)
640 K - 800 K	A0000 - C7FFF	160 KB	Video memory and BIOS
639 K - 640 K	9FC00 - 9FFFF	1 KB	Extended BIOS data (movable by memory manager software)
512 K - 639 K	80000 - 9FBFF	127 KB	Extended conventional memory
0 K - 512 K	00000 - 7FFFF	512 KB	Conventional memory

## 2.3 I/O Map

**Table 12. I/O Map**

Address (hex)	Size	Description
0000 - 000F	16 bytes	DMA controller
0020 - 0021	2 bytes	Programmable Interrupt Control (PIC)
0040 - 0043	4 bytes	System timer
0060	1 byte	Keyboard controller byte—reset IRQ
0061	1 byte	System speaker
0064	1 byte	Keyboard controller, CMD / STAT byte
0070 - 0071	2 bytes	System CMOS / Real Time Clock
0072 - 0073	2 bytes	System CMOS
0080 - 008F	16 bytes	DMA controller
0092	1 byte	Fast A20 and PIC
00A0 - 00A1	2 bytes	PIC
00B2 - 00B3	2 bytes	APM control
00C0 - 00DF	32 bytes	DMA
00F0	1 byte	Numeric data processor
0170 - 0177	8 bytes	Secondary IDE channel
01F0 - 01F7	8 bytes	Primary IDE channel
One of these ranges: 0220 - 022F 0240 - 024F	16 bytes	Audio (Sound Blaster Pro <sup>†</sup> -compatible)
0228 - 022F*	8 bytes	LPT3
0278 - 027F*	8 bytes	LPT2
02E8 - 02EF*	8 bytes	COM4 / video (8514A)
02F8 - 02FF*	8 bytes	COM2
0376	1 byte	Secondary IDE channel command port
0377, bits 6:0	7 bits	Secondary IDE channel status port
0378 - 037F	8 bytes	LPT1
03B0 - 03BB	12 bytes	Intel 82850 MCH
03C0 - 03DF	32 bytes	Intel 82850 MCH
03E8 - 03EF	8 bytes	COM3
03F0 - 03F5	6 bytes	Diskette channel 1
03F6	1 byte	Primary IDE channel command port
03F8 - 03FF	8 bytes	COM1
04D0 - 04D1	2 bytes	Edge / level triggered PIC
LPTn + 400	8 bytes	ECP port, LPTn base address + 400h
0CF8 - 0CFB**	4 bytes	PCI configuration address register
0CF9***	1 byte	Turbo and reset control register
0CFC - 0CFF	4 bytes	PCI configuration data register
FFA0 - FFA7	8 bytes	Primary bus master IDE registers
FFA8 - FFAF	8 bytes	Secondary bus master IDE registers

continued

**Table 12. I/O Map** (continued)

Address (hex)	Size	Description
96 contiguous bytes starting on a 128-byte divisible boundary		ICH2 (ACPI + TCO)
64 contiguous bytes starting on a 64-byte divisible boundary		D850GB board resource
64 contiguous bytes starting on a 64-byte divisible boundary		Onboard audio controller
32 contiguous bytes starting on a 32-byte divisible boundary		ICH2 (USB controller #1)
16 contiguous bytes starting on a 16-byte divisible boundary		ICH2 (SMBus)
4096 contiguous bytes starting on a 4096-byte divisible boundary		Intel 82801BA PCI bridge
256 contiguous bytes starting on a 256-byte divisible boundary		ICH2 audio mixer
64 contiguous bytes starting on a 64-byte divisible boundary		ICH2 audio bus mixer
256 contiguous bytes starting on a 256-byte divisible boundary		ICH2 modem mixer
32 contiguous bytes starting on a 32-byte divisible boundary		ICH2 (USB controller #2)
96 contiguous bytes starting on a 128-byte divisible boundary		LPC47M102

\* Default, but can be changed to another address range.

\*\* Dword access only.

\*\*\* Byte access only.

## ⇒ NOTE

*Some additional I/O addresses are not available due to ICH2 address aliasing. For information about the ICH2 addressing, refer to Section 1.2 on page 16.*

## 2.4 DMA Channels

**Table 13. DMA Channels**

DMA Channel Number	Data Width	System Resource
0	8- or 16-bits	Audio
1	8- or 16-bits	Audio / parallel port
2	8- or 16-bits	Diskette drive
3	8- or 16-bits	Parallel port (for ECP or EPP) / audio
4	8- or 16-bits	DMA controller
5	16-bits	Open
6	16-bits	Open
7	16-bits	Open

## 2.5 PCI Configuration Space Map

**Table 14. PCI Configuration Space Map**

Bus Number (hex)	Device Number (hex)	Function Number (hex)	Description
00	00	00	Memory controller of Intel 82850 component
00	01	00	PCI to AGP bridge
00	02	00	Intel 82850 MCH
00	1E	00	Hub link to PCI bridge
00	1F	00	Intel 82801BA ICH2 PCI to LPC bridge
00	1F	01	IDE controller
00	1F	02	USB
00	1F	03	SMBus controller
00	1F	04	USB
00	1F	05	AC '97 audio controller (optional)
00	1F	06	AC '97 modem controller (optional)
01	00	00	Add-in AGP adapter card
02	08	00	LAN controller (optional)
02	09	00	PCI bus connector 1 (J4E1)
02	0A	00	PCI bus connector 2 (J4D1)
02	0B	00	PCI bus connector 3 (J4C1)
02	0C	00	PCI bus connector 4 (J4B1)
02	0D	00	PCI bus connector 5 (J4A1)

## 2.6 Interrupts

**Table 15. Interrupts**

IRQ	System Resource
NMI	I/O channel check
0	Reserved, interval timer
1	Reserved, keyboard buffer full
2	Reserved, cascade interrupt from slave PIC
3	COM2 <sup>(Note)</sup>
4	COM1 <sup>(Note)</sup>
5	LPT2 (Plug and Play option) / Audio / User available
6	Diskette drive
7	LPT1 <sup>(Note)</sup>
8	Real-time clock
9	Reserved for ICH2 system management bus
10	User available
11	User available
12	Onboard mouse port (if present, else user available)
13	Reserved, math coprocessor
14	Primary IDE (if present, else user available)
15	Secondary IDE (if present, else user available)

Note: Default, but can be changed to another IRQ.

## 2.7 PCI Interrupt Routing Map

This section describes interrupt sharing and how the interrupt signals are connected between the PCI bus connectors and onboard PCI devices. The PCI specification specifies how interrupts can be shared between devices attached to the PCI bus. In most cases, the small amount of latency added by interrupt sharing does not affect the operation or throughput of the devices. In some special cases where maximum performance is needed from a device, a PCI device should not share an interrupt with other PCI devices. Use the following information to avoid sharing an interrupt with a PCI add-in card.

PCI devices are categorized as follows to specify their interrupt grouping:

- **INTA:** By default, all add-in cards that require only one interrupt are in this category. For almost all cards that require more than one interrupt, the first interrupt on the card is also classified as INTA.
- **INTB:** Generally, the second interrupt on add-in cards that require two or more interrupts is classified as INTB. (This is not an absolute requirement.)
- **INTC and INTD:** Generally, a third interrupt on add-in cards is classified as INTC and a fourth interrupt is classified as INTD.

The ICH2 has eight programmable interrupt request (PIRQ) input signals. All PCI interrupt sources either onboard or from a PCI add-in card connect to one of these PIRQ signals. Some PCI interrupt sources are electrically tied together on the D850GB board and therefore share the same interrupt. Table 16 shows an example of how the PIRQ signals are routed on the D850GB board.

For example, using Table 16 as a reference, assume an add-in card using INTA is plugged into PCI bus connector 4. In PCI bus connector 4, INTA is connected to PIRQB, which is already connected to the SMBus. The add-in card in PCI bus connector 4 now shares interrupts with these onboard interrupt sources.

**Table 16. PCI Interrupt Routing Map**

PCI Interrupt Source	ICH2 PIRQ Signal Name				
	PIRQF	PIRQG	PIRQH	PIRQB	Other
AGP connector				INTB	INTA to PIRQA
ICH2 USB controller					INTD to PIRQD
SMBus controller				INTB	
ICH2 USB controller					INTC to PIRQC
ICH2 Audio / Modem				INTB	
ICH2 LAN					INTA to PIRQE
PCI Bus Connector 1 (J4E1)	INTA	INTB	INTC	INTD	
PCI Bus Connector 2 (J4D1)	INTD	INTA	INTB	INTC	
PCI Bus Connector 3 (J4C1)	INTC	INTD	INTA	INTB	
PCI Bus Connector 4 (J4B1)	INTB	INTC	INTD	INTA	
PCI Bus Connector 5 (J4A1)	INTA	INTB	INTC	INTD	

⇒ **NOTE**

*The ICH2 can connect each PIRQ line internally to one of the IRQ signals (3, 4, 5, 6, 7, 9, 10, 11, 12, 14, and 15). Typically, a device that does not share a PIRQ line will have a unique interrupt. However, in certain interrupt-constrained situations, it is possible for two or more of the PIRQ lines to be connected to the same IRQ signal.*

## 2.8 Connectors



### CAUTION

*Only the back panel connectors of the D850GB board have overcurrent protection. The D850GB board's internal connectors are not overcurrent protected and should connect only to devices inside the computer's chassis, such as fans and internal peripherals. Do not use these connectors to power devices external to the computer's chassis. A fault in the load presented by the external devices could cause damage to the computer, the interconnecting cable, and the external devices themselves.*

This section describes the board's connectors. The connectors can be divided into the following groups:

- Back panel I/O connectors (see page 50)
  - PS/2 keyboard and mouse
  - USB (2)
  - Parallel port
  - Serial port
  - LAN
  - Audio (Line out, Line in, and Mic in)
- Internal I/O connectors (see page 53)
  - Audio (ATAPI CD-ROM, legacy-style CD-ROM, and auxiliary line input)
  - Fans (4)
  - Power (3)
  - Wake on LAN technology
  - Wake on Ring
  - Add-in boards (one CNR connector, one AGP connector, and five PCI bus connectors)
  - IDE (2)
  - Diskette drive
  - SCSI LED
- External I/O connectors (see page 65)
  - Front panel USB
  - Front panel (power/sleep/message-waiting LED, power switch, hard drive activity LED, reset switch, infrared port, and auxiliary front panel power LED)

## 2.8.1 Back Panel Connectors

Figure 8 shows the location of the back panel connectors. The back panel connectors are color-coded in compliance with PC 99 recommendations. The figure legend below lists the colors used.

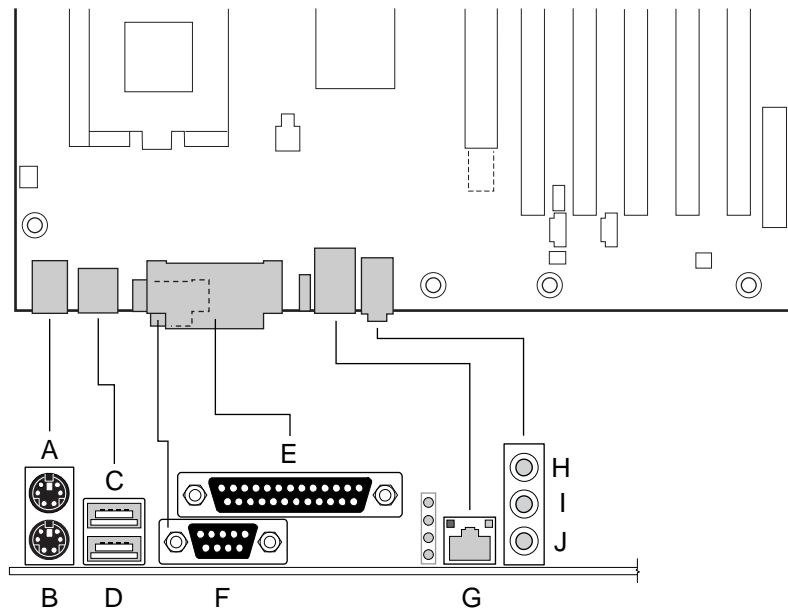

OM10443

Item	Description	Color	For more information see:
A	PS/2 mouse port	Green	Table 17
B	PS/2 keyboard port	Purple	Table 17
C	USB port 0	Black	Table 18
D	USB port 1	Black	Table 18
E	Parallel port	Burgundy	Table 19
F	Serial port	Teal	Table 20
G	LAN (optional)	Black	Table 21
H	Audio line in (optional)	Light blue	Table 22
I	Audio line out (optional)	Lime green	Table 23
J	Mic in (optional)	Pink	Table 24

**Figure 8. Back Panel Connectors**

### ⇒ NOTE

*The back panel audio line out connector is designed to power headphones or amplified speakers only. Poor audio quality occurs if passive (non-amplified) speakers are connected to this output.*

**Table 17. PS/2 Mouse/Keyboard Connector**

Pin	Signal Name
1	Data
2	Not connected
3	Ground
4	Fused +5 V
5	Clock
6	Not connected

**Table 18. USB Connectors**

Pin	Signal Name
1	+5 V (fused)
2	USBP0# [USBP1#]
3	USBP0 [USBP1]
4	Ground

Signal names in brackets ( [ ] ) are for USB port 1.

**Table 19. Parallel Port Connector**

Pin	Standard Signal Name	ECP Signal Name	EPP Signal Name
1	STROBE#	STROBE#	WRITE#
2	PD0	PD0	PD0
3	PD1	PD1	PD1
4	PD2	PD2	PD2
5	PD3	PD3	PD3
6	PD4	PD4	PD4
7	PD5	PD5	PD5
8	PD6	PD6	PD6
9	PD7	PD7	PD7
10	ACK#	ACK#	INTR
11	BUSY	BUSY#, PERIPHACK	WAIT#
12	PERROR	PE, ACKREVERSE#	PE
13	SELECT	SELECT	SELECT
14	AUDOFD#	AUDOFD#, HOSTACK	DATASTB#
15	FAULT#	FAULT#, PERIPHREQST#	FAULT#
16	INIT#	INIT#, REVERSERQST#	RESET#
17	SLCTIN#	SLCTIN#	ADDRSTB#
18 – 25	GND	GND	GND

**Table 20. Serial Port Connector**

Pin	Signal Name
1	DCD (Data Carrier Detect)
2	RXD# (Receive Data)
3	TXD# (Transmit Data)
4	DTR (Data Terminal Ready)
5	Ground
6	DSR (Data Set Ready)
7	RTS (Request to Send)
8	CTS (Clear to Send)
9	RI (Ring Indicator)

**Table 21. LAN Connector (optional)**

Pin	Signal Name
1	TX+
2	TX-
3	RX+
4	Ground
5	Ground
6	RX-
7	Ground
8	Ground

**Table 22. Audio Line In Connector (optional)**

Pin	Signal Name
Tip	Audio left in
Ring	Audio right in
Sleeve	Ground

**Table 23. Audio Line Out Connector (optional)**

Pin	Signal Name
Tip	Audio left out
Ring	Audio right out
Sleeve	Ground

**Table 24. Mic In Connector (optional)**

Pin	Signal Name
Tip	Mono in
Ring	Mic bias voltage
Sleeve	Ground

## 2.8.2 Internal I/O Connectors

The internal I/O connectors are divided into the following functional groups:

- Audio (see page 54)
  - Auxiliary line in
  - ATAPI CD-ROM
  - Legacy style (2-mm) CD-ROM
  - PC/PCI
- Power and hardware control (see page 56)
  - Fans (4)
  - ATX12V
  - Main power
  - Auxiliary power
  - Wake on LAN technology
  - Wake on ring connector
- Add-in boards and peripheral interfaces (see page 59)
  - CNR (communication and networking riser)
  - PCI bus (5)
  - AGP
  - IDE (2)
  - SCSI LED
  - Diskette drive

### 2.8.2.1 Expansion Slots

The board has the following expansion slots:

- One Accelerated Graphics Port (ATX Expansion slot 6, J5E1), or AGP50 Graphic Port (optional).
- Five PCI Local Bus slots (compliant with PCI rev 2.2 specification). The SMBus is routed to PCI bus connector 2 only (ATX Expansion slot 4, J4B1). PCI add-in cards with SMBus support can access sensor data and other information residing on the desktop board.
- One CNR (optional), shared with PCI bus connector 5 (ATX Expansion slot 1, J4A1).

#### ⇒ NOTE

*This document references back-panel slot numbering with respect to processor location on the board. The AGP slot is not numbered. PCI slots are identified as PCI slot #x, starting with the slot closest to the processor. The CNR slot shares PCI slot 5.*

*The ATX/MicroATX specifications identify expansion slot locations with respect to the far edge of a full-sized ATX chassis. The ATX specification and the board's silkscreen are opposite and could cause confusion. The ATX numbering convention is made without respect to slot type (PCI vs. AGP), but refers to an actual slot location on a chassis. Figure 11 on page 59 illustrates the board's PCI slot numbering.*

### 2.8.2.2 Audio Connectors

Figure 9 shows the location of the audio connectors.

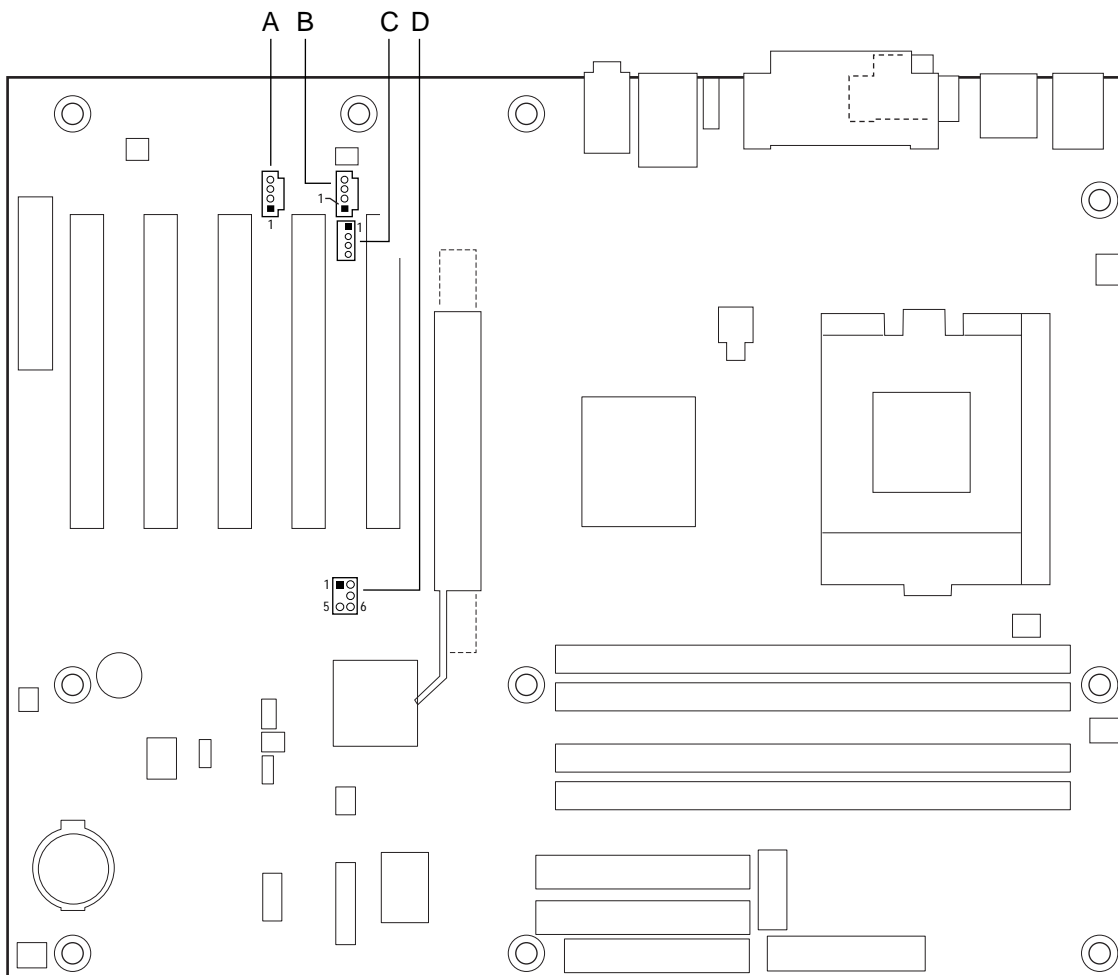

OM10444

Item	Description	Color	Reference Designator	For more information see:
A	Auxiliary line in, ATAPI style	White	J2C1	Table 25
B	ATAPI CD-ROM	Black	J2D1	Table 26
C	CD-ROM, Legacy style, 2 mm	White	J2D2	Table 27
D	PC/PCI	N/A	J6D1	Table 28

**Figure 9. Audio Connectors**

**Table 25. Auxiliary Line In Connector (J2C1)**

Pin	Signal Name
1	Left auxiliary line in
2	Ground
3	Ground
4	Right auxiliary line in

**Table 26. ATAPI CD-ROM Connector (J2D1)**

Pin	Signal Name
1	Left audio input from CD-ROM
2	CD audio differential ground
3	CD audio differential ground
4	Right audio input from CD-ROM

**Table 27. CD-ROM Legacy Style Connector (J2D2)**

Pin	Signal Name
1	CD_Ground
2	CD_IN-Left
3	CD_Ground
4	CD_IN-Right

**Table 28. PC/PCI Connector (J6D1)**

Pin	Signal Name	Pin	Signal Name
1	P_PCIGNTA#	2	Ground
3	Key (no pin)	4	P_PCIREQA#
5	Ground	6	SER_IRQ

### 2.8.2.3 Power and Hardware Control Connectors

Figure 10 shows the location of the power and hardware control connectors.

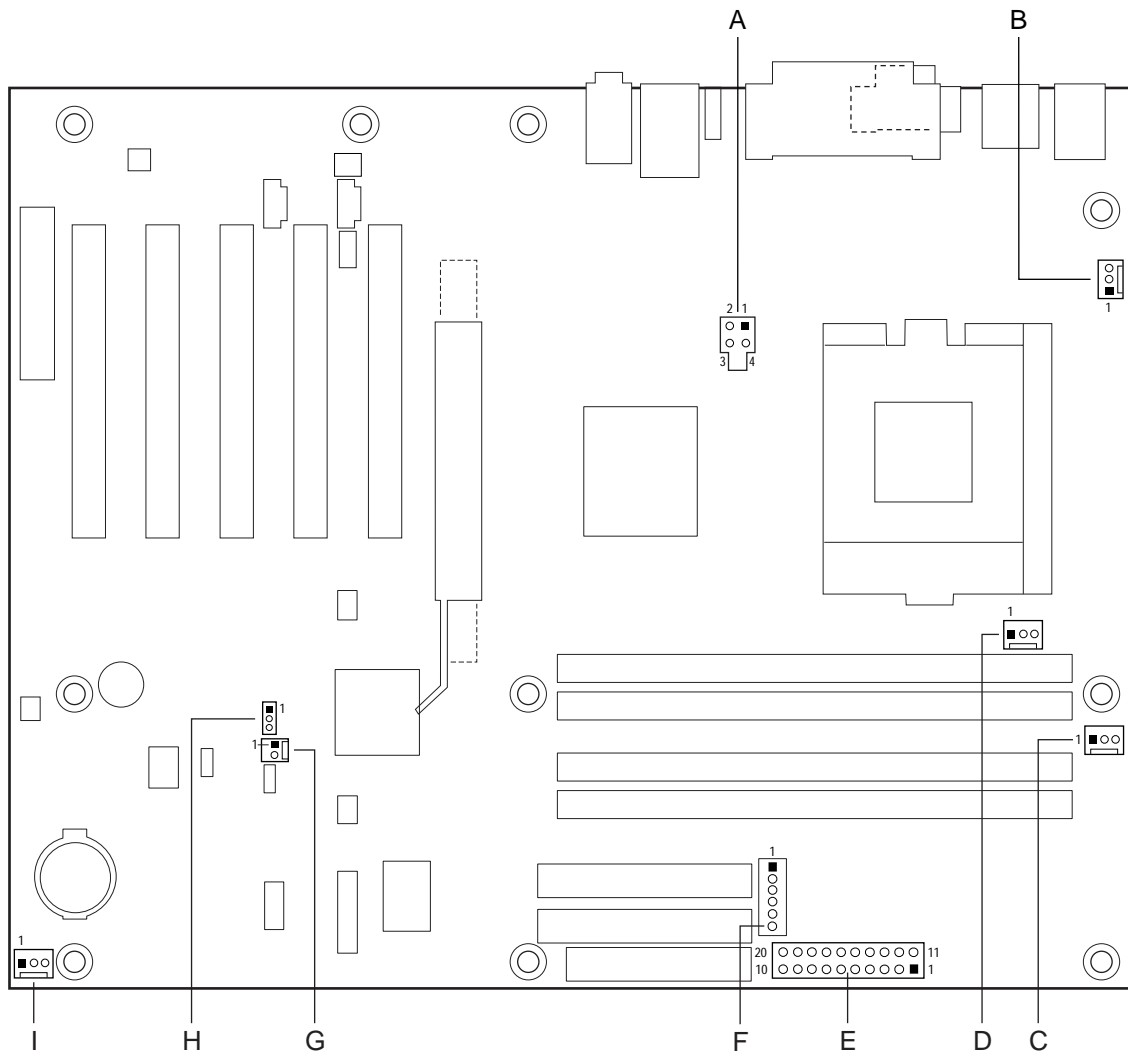

OM10445

Item	Description	Reference Designator	For more information see:
A	ATX12V power connector	J3H1	Table 29
B	Processor voltage regulator fan (Fan 4)	J3M1	Table 30
C	RIMM fan (Fan 2)	J7M2	Table 31
D	Processor fan (Fan 3)	J6L1	Table 32
E	Main power	J10K1	Table 33
F	Auxiliary power	J9J1	Table 34
G	Wake on Ring	J8C1	Table 35
H	Wake on LAN technology	J7C1	Table 36
I	Chassis fan (Fan 1)	J10A2	Table 37

**Figure 10. Power and Hardware Control Connectors**

For information about	Refer to
The power connector	Section 1.12.2.1, page 37
The functions of the fan connectors	Section 1.12.2.2, page 38
Wake on LAN technology	Section 1.12.2.3, page 39

**Table 29. ATX12V Power Connector (J3H1)**

Pin	Signal Name	Pin	Signal Name
1	Ground	3	+12 V
2	Ground	4	+12 V

**Table 30. Processor Voltage Regulator Fan Connector (J3M1)**

Pin	Signal Name
1	Ground
2	+12 V
3	Tachometer (FAN_4)

**Table 31. RIMM Fan Connector (J7M2)**

Pin	Signal Name
1	Ground
2	+12 V
3	Tachometer (FAN_2)

**Table 32. Processor Fan Connector (J6L1)**

Pin	Signal Name
1	Ground
2	+12 V
3	Tachometer (FAN_3)

**Table 33. Main Power Connector (J10K1)**

Pin	Signal Name	Pin	Signal Name
1	+3.3 V	11	+3.3 V
2	+3.3 V	12	-12 V
3	Ground	13	Ground
4	+5 V	14	PS-ON# (power supply remote on/off)
5	Ground	15	Ground
6	+5 V	16	Ground
7	Ground	17	Ground
8	PWRGD (Power Good)	18	TP_PWRCONN_18
9	+5 V (Standby)	19	+5 V
10	+12 V	20	+5 V

**Table 34. Auxiliary Power (J9J1)**

Pin	Signal Name
1	Ground
2	Ground
3	Ground
4	+3.3 V
5	+3.3 V
6	+5 V

**Table 35. Wake on Ring Connector (J8C1)**

Pin	Signal Name
1	Ground
2	Ring Indicate

**Table 36. Wake on LAN Technology Connector (J7C1)**

Pin	Signal Name
1	+5 VSB
2	Ground
3	WOL

**Table 37. Chassis Fan Connector (J10A2)**

Pin	Signal Name
1	Ground
2	+12 V
3	Tachometer (FAN_1)

### 2.8.2.4 Add-in Board and Peripheral Interface Connectors

Figure 11 shows the location of the add-in board connector and peripheral connectors. Note the following considerations for the PCI bus connectors:

- All of the PCI bus connectors are bus master capable.
- PCI bus connector 2 has SMBus signals routed to it. This enables PCI bus add-in boards with SMBus support to access sensor data on the board. The specific SMBus signals are as follows:
  - The SMBus clock line is connected to pin A40
  - The SMBus data line is connected to pin A41

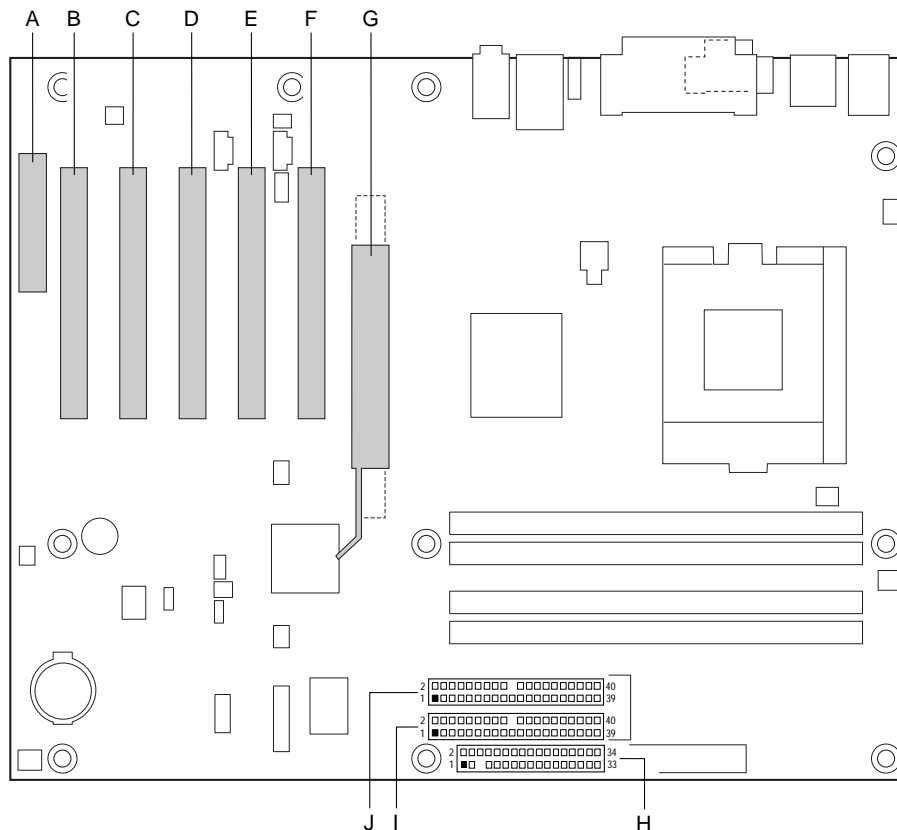

OM10446

Item	Description	Reference Designator	For more information see:
A	Communication and networking riser (CNR)	J3A1	Table 38
B	PCI bus connector 5	J4A1	Table 39
C	PCI bus connector 4	J4B1	Table 39
D	PCI bus connector 3	J4C1	Table 39
E	PCI bus connector 2	J4D1	Table 39
F	PCI bus connector 1	J4E1	Table 39
G	AGP connector	J5E1	Table 40
H	Diskette drive	J10G1	Table 42
I	Primary IDE	J9G2	Table 41
J	Secondary IDE	J9G1	Table 41

Figure 11. Add-in Board and Peripheral Interface Connectors

**Table 38. CNR Connector (J3A1)**

Pin	Signal Name	Pin	Signal Name
A1	Reserved	B1	Reserved
A2	Reserved	B2	Reserved
A3	Ground	B3	Reserved
A4	Reserved	B4	Ground
A5	Reserved	B5	Reserved
A6	Ground	B6	Reserved
A7	LAN_TXD2	B7	Ground
A8	LAN_TXD0	B8	LAN_TXD1
A9	Ground	B9	LAN_RSTSYNC
A10	LAN_CLK	B10	Ground
A11	LAN_RXD1	B11	LAN_RXD2
A12	Reserved	B12	LAN_RXD0
A13	USB+	B13	Ground
A14	GND	B14	Reserved
A15	USB-	B15	+5VDUAL
A16	+12V	B16	USB_OC
A17	GND	B17	Ground
A18	+3.3VDUAL	B18	-12V
A19	+5VD	B19	+3.3VD
A20	Ground	B20	Ground
A21	EEDI	B21	EED0
A22	EECS	B22	EECK
A23	SMB_A1	B23	Ground
A24	SMB_A2	B24	SMB_A0
A25	SMB_SDA	B25	SMB_SCL
A26	AC97_RESET	B26	CDC_DWN_ENAB
A27	Reserved	B27	Ground
A28	AC97_SDATA_IN1	B28	AC97_SYNC
A29	AC97_SDATA_IN0	B29	AC97_SDATA_OUT
A30	GND	B30	AC97_BITCLK

**For information about**

The CNR

**Refer to**

Section 1.10, page 31

**Table 39. PCI Bus Connectors (J4A1, J4B1, J4C1, J4D1, J4E1)**

Pin	Signal Name	Pin	Signal Name	Pin	Signal Name	Pin	Signal Name
A1	Ground (TRST#)*	B1	-12 V	A32	AD16	B32	AD17
A2	+12 V	B2	Ground (TCK)*	A33	+3.3 V	B33	C/BE2#
A3	+5 V (TMS)*	B3	Ground	A34	FRAME#	B34	Ground
A4	+5 V (TDI)*	B4	no connect (TDO)*	A35	Ground	B35	IRDY#
A5	+5 V	B5	+5 V	A36	TRDY#	B36	+3.3 V
A6	INTA#	B6	+5 V	A37	Ground	B37	DEVSEL#
A7	INTC#	B7	INTB#	A38	STOP#	B38	Ground
A8	+5 V	B8	INTD#	A39	+3.3 V	B39	LOCK#
A9	Reserved	B9	no connect (PRSNT1#)*	A40	Reserved **	B40	PERR#
A10	+5 V (I/O)	B10	Reserved	A41	Reserved ***	B41	+3.3 V
A11	Reserved	B11	no connect (PRSNT2#)*	A42	Ground	B42	SERR#
A12	Ground	B12	Ground	A43	PAR	B43	+3.3 V
A13	Ground	B13	Ground	A44	AD15	B44	C/BE1#
A14	+3.3 V aux	B14	Reserved	A45	+3.3 V	B45	AD14
A15	RST#	B15	Ground	A46	AD13	B46	Ground
A16	+5 V (I/O)	B16	CLK	A47	AD11	B47	AD12
A17	GNT#	B17	Ground	A48	Ground	B48	AD10
A18	Ground	B18	REQ#	A49	AD09	B49	Ground
A19	PME#	B19	+5 V (I/O)	A50	Key	B50	Key
A20	AD30	B20	AD31	A51	Key	B51	Key
A21	+3.3 V	B21	AD29	A52	C/BE0#	B52	AD08
A22	AD28	B22	Ground	A53	+3.3 V	B53	AD07
A23	AD26	B23	AD27	A54	AD06	B54	+3.3 V
A24	Ground	B24	AD25	A55	AD04	B55	AD05
A25	AD24	B25	+3.3 V	A56	Ground	B56	AD03
A26	IDSEL	B26	C/BE3#	A57	AD02	B57	Ground
A27	+3.3 V	B27	AD23	A58	AD00	B58	AD01
A28	AD22	B28	Ground	A59	+5 V (I/O)	B59	+5 V (I/O)
A29	AD20	B29	AD21	A60	REQ64C#	B60	ACK64C#
A30	Ground	B30	AD19	A61	+5 V	B61	+5 V
A31	AD18	B31	+3.3 V	A62	+5 V	B62	+5 V

\* These signals (in parentheses) are optional in the PCI specification and are not currently implemented.

\*\* On PCI bus connector 2 (J4D1), this pin is connected to the SMBus clock line.

\*\*\* On PCI bus connector 2 (J4D1), this pin is connected to the SMBus data line.

**Table 40. AGP Connector (J5E1)**

Pin	Signal Name	Pin	Signal Name	Pin	Signal Name	Pin	Signal Name
A1	+12V	B1	No Connect	A34	Vcc3.3	B34	Vcc3.3
A2	TYPEDET#	B2	Vcc	A35	AD22	B35	AD21
A3	Reserved	B3	Vcc	A36	AD20	B36	AD19
A4	No Connect	B4	No Connect	A37	Ground	B37	Ground
A5	Ground	B5	Ground	A38	AD18	B38	AD17
A6	INTA#	B6	INTB#	A39	AD16	B39	C/BE2#
A7	RST#	B7	CLK	A40	Vcc3.3	B40	Vcc3.3
A8	GNT1#	B8	REQ#	A41	FRAME#	B41	IRDY#
A9	Vcc3.3	B9	Vcc3.3	A42	Reserved	B42	+3.3 V aux
A10	ST1	B10	ST0	A43	Ground	B43	Ground
A11	Reserved	B11	ST2	A44	Reserved	B44	Reserved
A12	PIPE#	B12	RBF#	A45	Vcc3.3	B45	Vcc3.3
A13	Ground	B13	Ground	A46	TRDY#	B46	DEVSEL#
A14	WBF#	B14	No Connect	A47	STOP#	B47	Vcc3.3
A15	SBA1	B15	SBA0	A48	PME#	B48	PERR#
A16	Vcc3.3	B16	Vcc3.3	A49	Ground	B49	Ground
A17	SBA3	B17	SBA2	A50	PAR	B50	SERR#
A18	SBSTB#	B18	SB_STB	A51	AD15	B51	C/BE1#
A19	Ground	B19	Ground	A52	Vcc3.3	B52	Vcc3.3
A20	SBA5	B20	SBA4	A53	AD13	B53	AD14
A21	SBA7	B21	SBA6	A54	AD11	B54	AD12
A22	Key	B22	Key	A55	Ground	B55	Ground
A23	Key	B23	Key	A56	AD9	B56	AD10
A24	Key	B24	+3.3 V aux	A57	C/BE0#	B57	AD8
A25	Key	B25	Key	A58	Vcc3.3	B58	Vcc3.3
A26	AD30	B26	AD31	A59	AD_STB0#	B59	AD_STB0
A27	AD28	B27	AD29	A60	AD6	B60	AD7
A28	Vcc3.3	B28	Vcc3.3	A61	Ground	B61	Ground
A29	AD26	B29	AD27	A62	AD4	B62	AD5
A30	AD24	B30	AD25	A63	AD2	B63	AD3
A31	Ground	B31	Ground	A64	Vcc3.3	B64	Vcc3.3
A32	AD_STB1#	B32	AD_STB1	A65	AD0	B65	AD1
A33	C/BE3#	B33	AD23	A66	VRREFG_C	B66	VREFC_G

**Table 41. PCI IDE Connectors (J9G2, Primary and J9G1, Secondary)**

Pin	Signal Name	Pin	Signal Name
1	Reset IDE	2	Ground
3	Data 7	4	Data 8
5	Data 6	6	Data 9
7	Data 5	8	Data 10
9	Data 4	10	Data 11
11	Data 3	12	Data 12
13	Data 2	14	Data 13
15	Data 1	16	Data 14
17	Data 0	18	Data 15
19	Ground	20	Key
21	DDRQ0 [DDRQ1]	22	Ground
23	I/O Write#	24	Ground
25	I/O Read#	26	Ground
27	IOCHRDY	28	P_ALE (Cable Select pull-up)
29	DDACK0# [DDACK1#]	30	Ground
31	IRQ 14 [IRQ 15]	32	Reserved
33	DAG1 (Address 1)	34	GPIO_DMA66_Detect_Pri (GPIO_DMA66_Detect_Sec)
35	DAG0 (Address 0)	36	DAG2 (Address 2)
37	Chip Select 1P# [Chip Select 1S#]	38	Chip Select 3P# [Chip Select 3S#]
39	Activity#	40	Ground

Note: Signal names in brackets ([ ]) are for the secondary IDE connector.

**Table 42. Diskette Drive Connector (J10G1)**

Pin	Signal Name	Pin	Signal Name
1	Ground	2	DENSEL
3	Ground	4	Reserved
5	Key	6	FDEDIN
7	Ground	8	FDINDX# (Index)
9	Ground	10	FDM00# (Motor Enable A)
11	Ground	12	No connect
13	Ground	14	FDDS0# (Drive Select A)
15	Ground	16	No connect
17	No connect	18	FDDIR# (Stepper Motor Direction)
19	Ground	20	FDSTEP# (Step Pulse)
21	Ground	22	FDWD# (Write Data)
23	Ground	24	FDWE# (Write Enable)
25	Ground	26	FDTRK0# (Track 0)
27	No connect	28	FDWPD# (Write Protect)
29	Ground	30	FDRDATA# (Read Data)
31	Ground	32	FDHEAD# (Side 1 Select)
33	Ground	34	DSKCHG# (Diskette Change)

### 2.8.3 External I/O Connectors

Figure 12 shows the locations of the external I/O connectors.

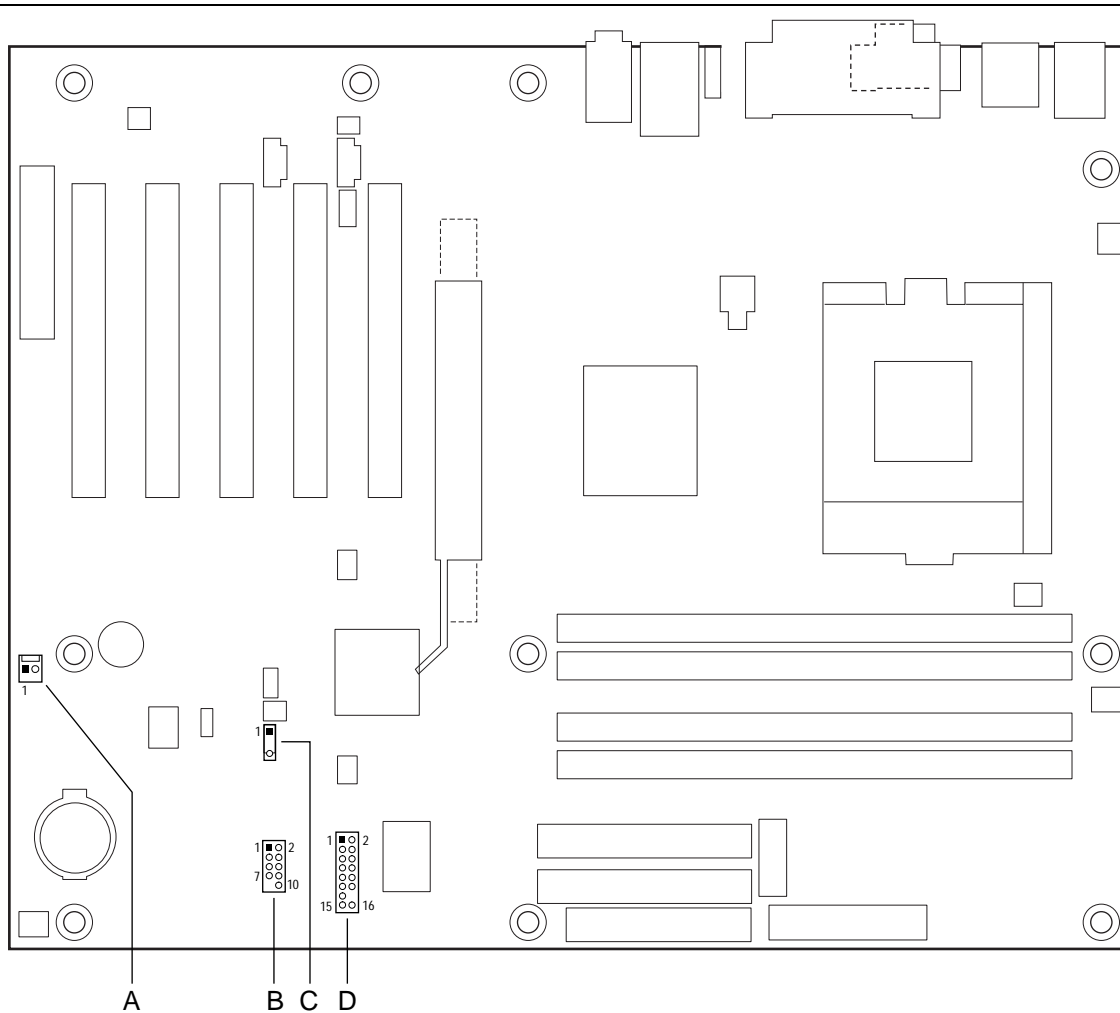

OM10447

Item	Description	Reference Designator	For more information see:
A	SCSI LED	J7A2	Table 43
B	Front panel USB	J9C1	Table 44
C	Auxiliary front panel power LED	J8C3	Table 45
D	Front panel	J9D2	Table 46

**Figure 12. External I/O Connectors**

**Table 43. SCSI LED Connector (J7A2)**

Pin	Signal Name
1	SCSI activity
2	Not connected

**Table 44. Front Panel USB Connector (J9C1)**

Pin	Signal Name	Pin	Signal Name
1	VREG_FP_USB_PWR	2	VREG_FP_USB_PWR
3	ICH_U_P2#	4	ICH_U_P3#
5	ICH_U_P2	6	ICH_U_P3
7	Ground	8	Ground
9	Key (no pin)	10	ICU_U_OC1_2#

### 2.8.3.1 Auxiliary Front Panel Power/Sleep/Message Waiting LED Connector

This connector duplicates on pins 1 and 3, the signals on pins 2 and 4 of the front panel connector.

**Table 45. Auxiliary Front Panel Power/Sleep/Message Waiting LED Connector (J8C3)**

Pin	Signal Name	In/Out	Description
1	HDR_BLNK_GRN	Out	Front panel green LED
2	No connect		
3	HDR_BLNK_YEL	Out	Front panel yellow LED

### 2.8.3.2 Front Panel Connector

This section describes the functions of the front panel connector. Table 46 lists the signal names of the front panel connector.

**Table 46. Front Panel Connector (J9D2)**

Pin	Signal	In/Out	Description	Pin	Signal	In/Out	Description
1	HD_PWR	Out	Hard disk LED pull-up (330 Ω) to +5 V	2	HDR_BLNK_GRN	Out	Front panel green LED
3	HAD#	Out	Hard disk active LED	4	HDR_BLNK_YEL	Out	Front panel yellow LED
5	GND		Ground	6	FPBUT_IN	In	Power switch
7	FP_RESET#	In	Reset switch	8	GND		Ground
9	+5 V	Out	IR Power	10	N/C		
11	Reserved	In	Reserved	12	GND		Ground
13	GND		Ground	14	(pin removed)		Not connected
15	Reserved	Out	Reserved	16	+5 V	Out	Power

#### 2.8.3.2.1 Reset Switch Connector

Pins 5 and 7 can be connected to a momentary SPST type switch that is normally open. When the switch is closed, the D850GB board resets and runs the POST.

#### 2.8.3.2.2 Hard Drive Activity LED Connector

Pins 1 and 3 can be connected to an LED to provide a visual indicator that data is being read from or written to a hard drive. For the LED to function properly, an IDE drive must be connected to the onboard IDE interface. The LED will also show activity for devices connected to the SCSI hard drive activity LED connector.

For information about	Refer to
The SCSI hard drive activity LED connector	Section 0, page 25

#### 2.8.3.2.3 Power/Sleep/Message Waiting LED Connector

Pins 2 and 4 can be connected to a single- or dual-colored LED. Table 47 shows the possible states for a single-colored LED. Table 48 shows the possible states for a dual-colored LED.

**Table 47. States for a One Color Power LED**

LED State	Description
Off	Power off/sleeping
Steady Green	Running
Blinking Green	Running/message waiting

**Table 48. States for a Two Color Power LED**

LED State	Description
Off	Power off
Steady Green	Running
Blinking Green	Running/message waiting
Steady Yellow	Sleeping
Blinking Yellow	Sleeping/message waiting

⇒ **NOTE**

*To use the message waiting function, ACPI must be enabled in the operating system and a message-capturing application must be invoked.*

#### **2.8.3.2.4 Power Switch Connector**

Pins 6 and 8 can be connected to a front panel momentary-contact power switch. The switch must pull the SW\_ON# pin to ground for at least 50 ms to signal the power supply to switch on or off. (The time requirement is due to internal debounce circuitry on the D850GB board.) At least two seconds must pass before the power supply will recognize another on/off signal.

## 2.9 Jumper Blocks

**⚠ CAUTION**

*Do not move any jumpers with the power on. Always turn off the power and unplug the power cord from the computer before changing a jumper setting. Otherwise, the board could be damaged.*

The board has two jumper blocks. Figure 13 shows the location of the jumper blocks.

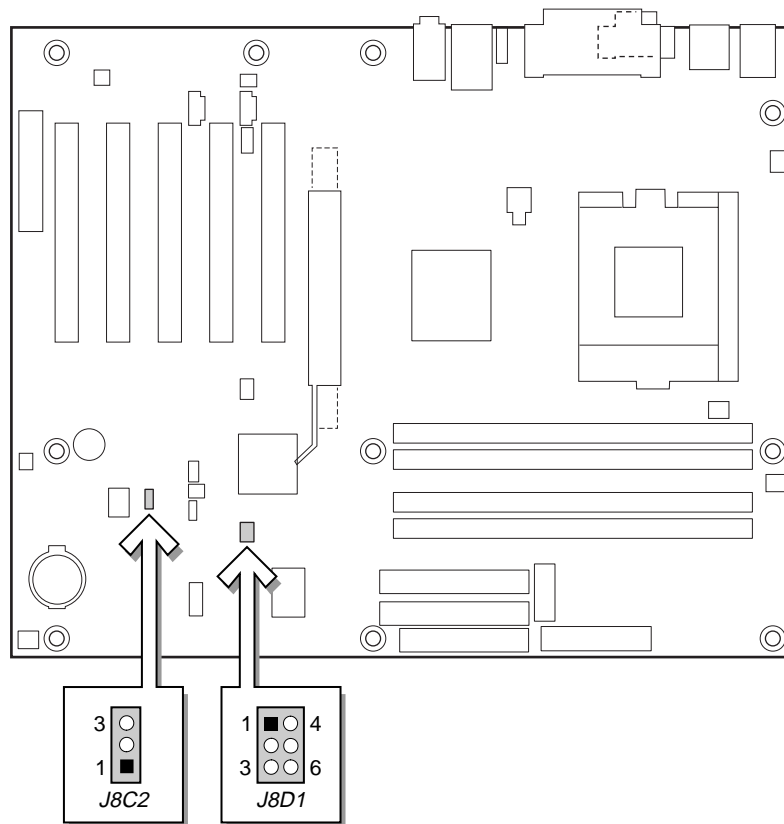

OM10448



Reference Designator	Description
J8C2	BIOS configuration jumper block
J8D1	USB front panel / CNR jumper block

**Figure 13. Location of the Jumper Blocks**

## 2.9.1 BIOS Setup Configuration Jumper Block

This 3-pin jumper block determines the BIOS Setup program's mode. Table 49 describes the jumper settings for the three modes: normal, configure, and recovery. When the jumper is set to configuration mode and the computer is powered-up, the BIOS compares the processor version and the microcode version in the BIOS and reports if the two match.

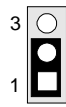
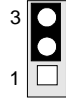
**Table 49. BIOS Setup Configuration Jumper Settings (J8C2)**

Function/Mode	Jumper Setting	Configuration
Normal	1-2 	The BIOS uses current configuration information and passwords for booting.
Configure	2-3 	After the POST runs, Setup runs automatically. The maintenance menu is displayed.
Recovery	None 	The BIOS attempts to recover the BIOS configuration. A recovery diskette is required.

**For information about**

**Refer to**

How to access the BIOS Setup program

Section 4.1, page 89

The maintenance menu of the BIOS Setup program

Section 4.2, page 90

BIOS recovery

Section 3.7, page 85

## 2.9.2 USB Port 2 Routing Jumper Block

This 6-pin jumper block routes the signals of USB port 2. Table 50 describes the jumper settings for USB port 2. Figure 13 shows the location of the Front Panel USB connector.

**Table 50. USB Port 2 Routing Jumper Settings (J8D1)**

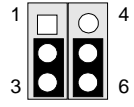
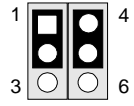
Jumper Setting	Configuration
2-3 and 5-6 	USB port 2 signals are routed to the Front Panel USB connector.
1-2 and 4-5 	USB port 2 signals are routed to the CNR connector.

**For information about**

**Refer to**

The location of the Front Panel USB connector

Figure 12, page 65

The location of the CNR connector

Figure 11, page 59

## 2.10 Mechanical Considerations

### 2.10.1 Form Factor

The D850GB board is designed to fit into an ATX-form-factor chassis. Figure 14 illustrates the mechanical form factor for the D850GB board. Dimensions are given in inches [millimeters]. The outer dimensions are 9.60 inches by 12.00 inches [243.84 millimeters by 304.80 millimeters]. Location of the I/O connectors and mounting holes are in compliance with the ATX specification (see Section 1.3).

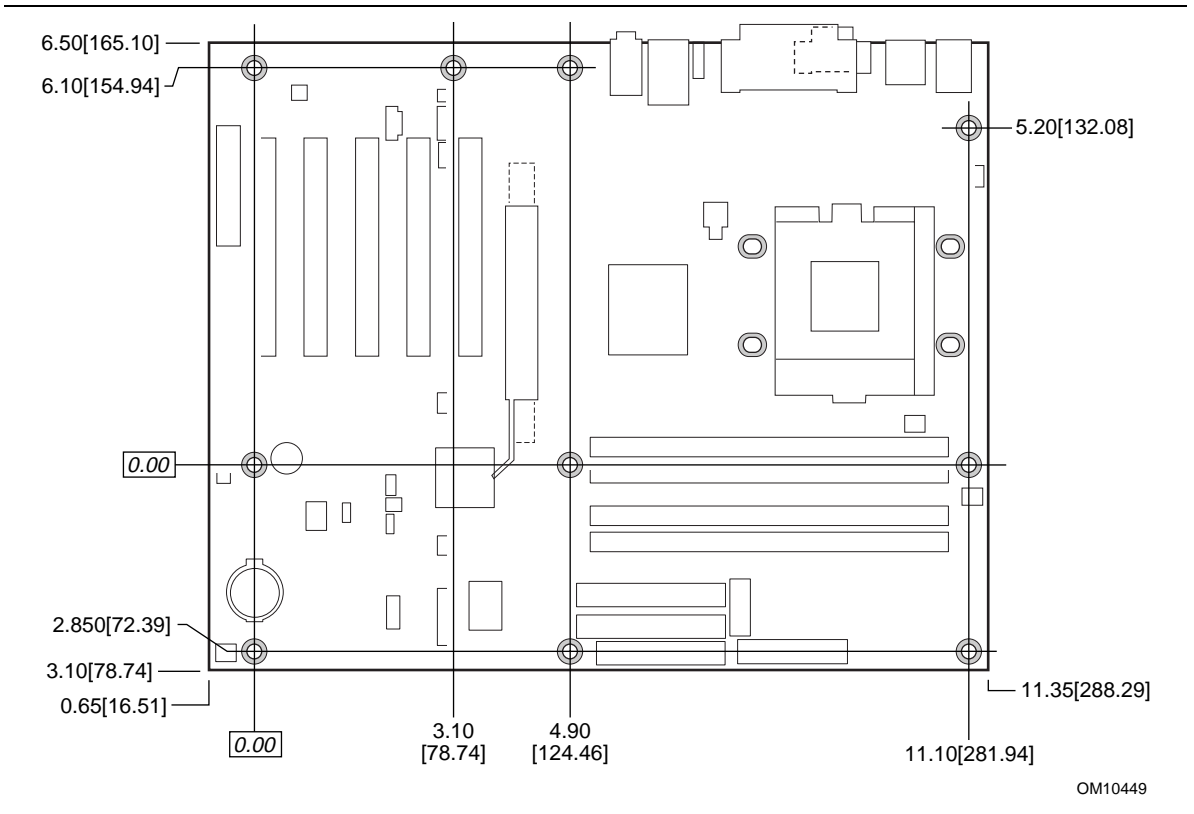

Figure 14. D850GB Board Dimensions

⇒ **NOTE**

*There may be mechanical interference with installed RDRAM modules in some combinations of ATX chassis and peripherals, such as CD-ROM drives.*

## 2.10.2 I/O Shield

The back panel I/O shield for the D850GB board must meet specific dimension and material requirements. Systems based on this board need the back panel I/O shield to pass certification testing. Figure 15 shows the critical dimensions of the chassis-dependent I/O shield. Dimensions are given in inches to a tolerance of  $\pm 0.02$  inches.

The figure also indicates the position of each cutout. Additional design considerations for I/O shields relative to chassis requirements are described in the ATX specification. See Section 1.3 for information about the ATX specification.

### NOTE

*An I/O shield compliant with the ATX chassis specification 2.01 is available from Intel.*

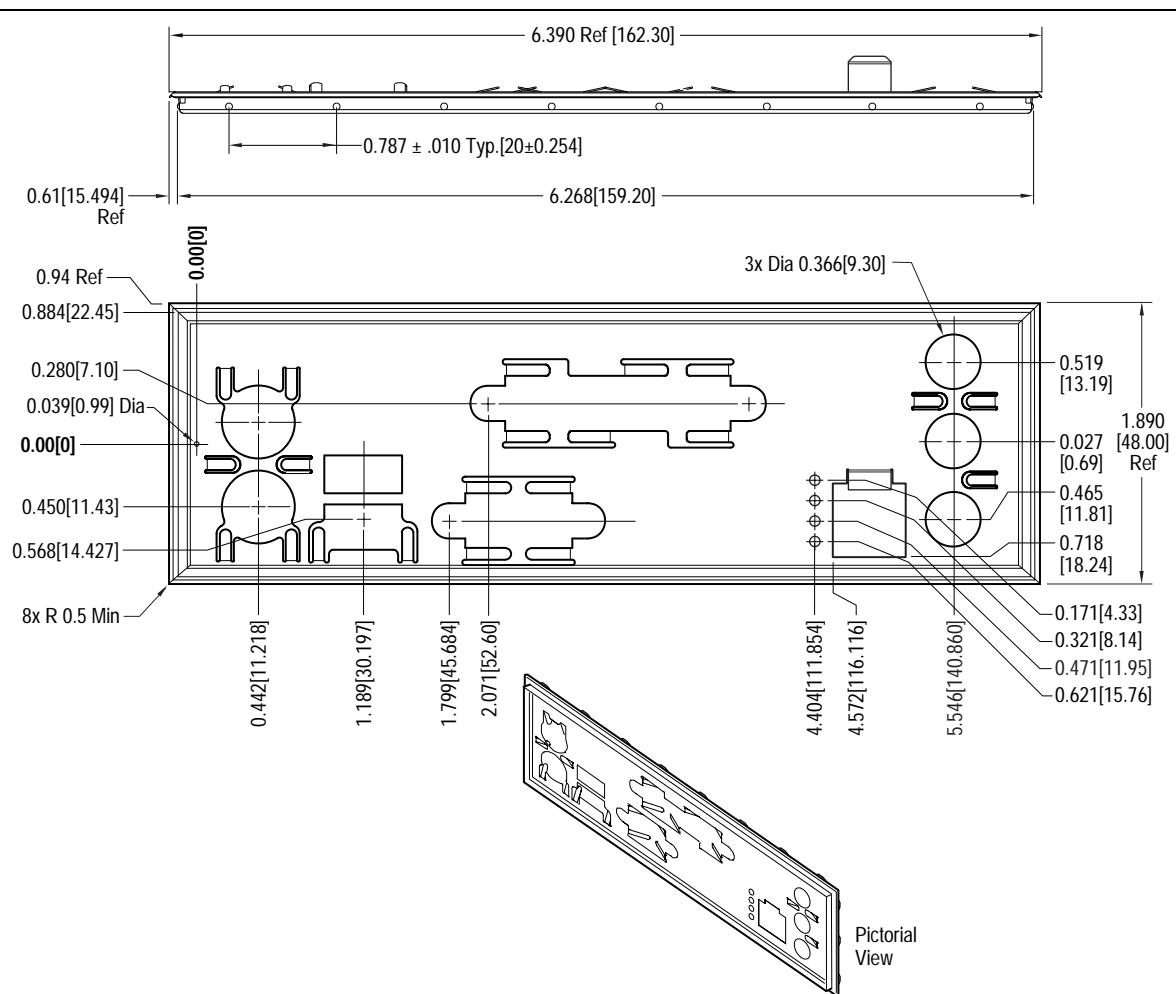

OM10451A

Figure 15. I/O Shield Dimensions

## 2.11 Electrical Considerations

### 2.11.1 Power Consumption

Table 51 lists voltage and current measurements for a computer that contains the D850GB board and the following:

- 1.4 GHz Intel Pentium 4 processor with a 256 KB cache
- 96 MB RDRAM
- 3.5-inch diskette drive
- 6.4 GB IDE hard disk drive
- 40X IDE CD-ROM drive

This information is provided only as a guide for calculating approximate power usage with additional resources added.

Values for the Windows 98 desktop mode are measured at 640 x 480 x 256 colors and 60 Hz refresh rate. AC watts are measured with the computer is connected to a typical 200 W power supply, at nominal input voltage and frequency, with a true RMS wattmeter at the line input.

⇒ **NOTE**

*Actual system power consumption depends upon system configuration. The power supply should comply with the recommendations found in the ATX12V Specification (see Table 3 on page 16 for specification information).*

**Table 51. Power Usage**

Mode	AC Power	DC Current at:				
		+3.3 V	+5 V	+12 V	-12 V	+5 VSB
Windows 98 APM full on	88.6 W	3.95 A	1.0 A	0.68 A	-0.27 A	0.18 A
Windows 98 APM Suspend	54.3 W	3.96 A	0.99 A	0.30 A	-0.24 A	0.14 A
Windows 98 ACPI S0	57.6 W	3.91 A	0.99 A	0.30 A	-0.26 A	0.21 A
Windows 98 ACPI S1	54.1 W	3.88 A	0.89 A	0.31 A	-0.27 A	0.21 A
Windows 98 ACPI S3	4.1 W	0.0 A	0.0 A	0.0 A	0.0 A	0.37 A

### 2.11.2 Add-in Board Considerations

The D850GB board is designed to provide 2 A (average) of +5 V current for each add-in board. The total +5 V current draw for add-in boards in a fully-loaded D850GB board (all six expansion slots filled) must not exceed 12A.

### 2.11.3 Standby Current Requirements



#### CAUTION

*If the standby current necessary to support multiple wake events from the PCI and/or USB buses exceeds power supply capacity, the D850GB board may lose register settings stored in memory, etc. Calculate the standby current requirements using the steps described below.*

Power supplies used with the D850GB board must be able to provide enough standby current to support the Instantly Available (ACPI S3 sleep state) configuration as outlined in Table 52 below.

Values are determined by specifications such as PCI 2.2. Actual measured values may vary.

To estimate the amount of standby current required for a particular system configuration, standby current requirements of all installed components must be added to determine the total standby current requirement. Refer to the descriptions in Table 52 and review the following steps.

1. Note the total D850GB board standby current requirement.
2. Add to that the total PS/2 port standby current requirement if a wake-enabled device is connected.
3. Add, from the PCI 2.2 slots (wake enabled) row, the total number of wake-enabled devices installed (PCI and AGP) and multiply by the standby current requirement.
4. Add, from the PCI 2.2 slots (non-wake enabled) row, the total number of wake-enabled devices installed (PCI and AGP) and multiply by the standby current requirement.
5. Add all additional wake enabled devices' and non-wake enabled devices' standby current requirements as applicable.
6. Add all the required current totals from steps 1 through 5 to determine the total estimated standby current power supply requirement.

**Table 52. Standby Current Requirements**

<b>Instantly Available Current Support (Estimated for Integrated Board Components)</b>	<b>Description</b>	<b>Standby Current Requirements (mA)</b>
	Total for D850GB board	300
<b>Instantly Available Stand-by Current Support</b>	PS/2 ports (Note)	345
	PCI 2.2 slots (wake enabled)	375
<ul style="list-style-type: none"> <li>• <b>Estimated for add-on Components</b></li> </ul>	PCI 2.2 slots (non-wake enabled)	20
	WOL header	525
<ul style="list-style-type: none"> <li>• <b>Add to Instantly Available total current requirement</b></li> </ul>	CNR (Note)	375
<b>(See instructions above)</b>	USB ports (Note)	500

Note: Dependent upon system configuration

⇒ **NOTE**

*IBM PS/2 Port Specification (Sept 1991) states:*

- 275 mA for keyboard
- 70 mA for the mouse (non wake-enable device)

*PCI/AGP requirements are calculated by totaling the following:*

- One wake-enabled device @ 375 mA, plus
- Five nonwake-enabled devices @ 20 mA each, plus

*USB requirements are calculated as:*

- One wake-enabled device @ 500 mA
- USB hub @ 100 mA
- Three USB nonwake-enabled devices connected @ 2.5 mA each

⇒ **NOTE**

*Both USB ports are capable of providing up to 500 mA during normal G0/S0 operation. Only one USB port will support up to 500 mA of stand-by-current (wake-enabled device) during G1/S3 suspended operation. The other port may provide up to 7.5 mA (three non-wake enabled devices.) during G1/S3 suspended operation.*

### 2.11.4 Fan Connector Current Capability

The D850GB board is designed to supply a maximum of 225 mA per fan connector.

### 2.11.5 Power Supply Considerations

 **CAUTION**

*The 5-V standby line for the power supply must be capable of providing adequate +5 V standby current. Failure to do so can damage the power supply. The total amount of standby current required depends on the wake devices supported and manufacturing options. Refer to Section 2.11.3 on page 74 for additional information.*

System integrators should refer to the power usage values listed in Table 51 when selecting a power supply for use with the D850GB board.

Measurements account only for current sourced by the D850GB board while running in idle modes of the started operating systems.

Additional power required will depend on configurations chosen by the integrator.

The power supply must comply with the following recommendations found in the indicated sections of the ATX form factor specification.

- The potential relation between 3.3 VDC and +5 VDC power rails (Section 4.2)
- The current capability of the +5 VSB line (Section 4.2.1.2)
- All timing parameters (Section 4.2.1.3)
- All voltage tolerances (Section 4.2.2)

**For information about**

The ATX form factor specification

**Refer to**

Section 1.3, page 16

## 2.12 Thermal Considerations

**⚠ CAUTION**

An ambient temperature that exceeds the board's maximum operating temperature by 5 °C to 10 °C could cause components to exceed their maximum case temperature and malfunction. For information about the maximum operating temperature, see the environmental specifications in Section 2.14.

**⚠ CAUTION**

The processor voltage regulator area (item A in Figure 16) can reach a temperature of up to 85 °C in an open chassis. System integrators should ensure that proper airflow is maintained in the voltage regulator circuit. Failure to do so may result in damage to the voltage regulator circuit.

Figure 16 shows the locations of the localized high temperature zones.

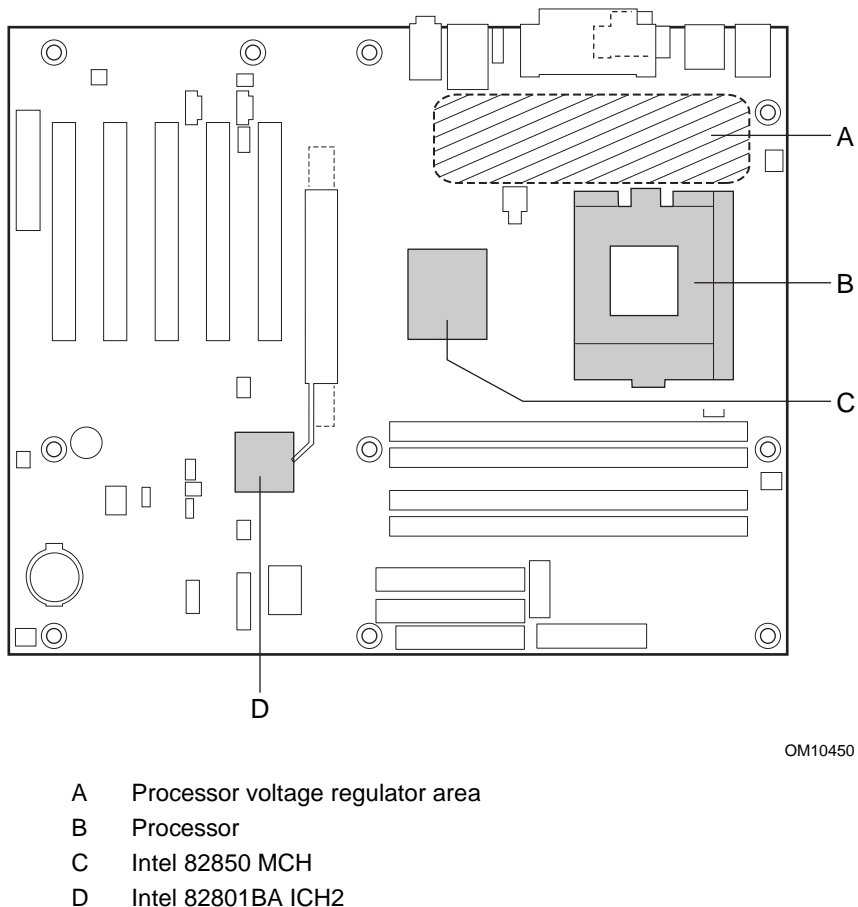

**Figure 16. Localized High Temperature Zones**

Table 53 provides maximum case temperatures for D850GB board components that are sensitive to thermal changes. Case temperatures could be affected by the operating temperature, current load, or operating frequency. Maximum case temperatures are important when considering proper airflow to cool the D850GB board.

**Table 53. Thermal Considerations for Components**

Component	Maximum Case Temperature
Intel Pentium 4 processor	For processor case temperature, see processor datasheets and processor specification updates
Intel 82850 MCH	105 °C (under bias)
Intel 82801BA ICH2	109 °C (under bias)

For information about	Refer to
Intel Pentium 4 processor datasheets and specification updates	Section 1.2, page 16

## 2.13 Reliability

The mean time between failures (MTBF) prediction is calculated using component and subassembly random failure rates. The calculation is based on the Bellcore Reliability Prediction Procedure, TR-NWT-000332, Issue 4, September 1991. The MTBF prediction is used to estimate repair rates and spare parts requirements.

The Mean Time Between Failures (MTBF) data is calculated from predicted data at 55 °C.

D850GB board MTBF: 104769.75 hours

## 2.14 Environmental

Table 54 lists the environmental specifications for the D850GB board.

**Table 54. D850GB Board Environmental Specifications**

Parameter	Specification		
<b>Temperature</b>			
Non-Operating	-40 °C to +70 °C		
Operating	0 °C to +55 °C		
<b>Shock</b>			
Unpackaged	30 g trapezoidal waveform		
	Velocity change of 170 inches/second		
Packaged	Half sine 2 millisecond		
	Product Weight (pounds)	Free Fall (inches)	Velocity Change (inches/sec)
	<20	36	167
	21-40	30	152
	41-80	24	136
	81-100	18	118
<b>Vibration</b>			
Unpackaged	5 Hz to 20 Hz: 0.01 g <sup>2</sup> Hz sloping up to 0.02 g <sup>2</sup> Hz		
	20 Hz to 500 Hz: 0.02 g <sup>2</sup> Hz (flat)		
Packaged	10 Hz to 40 Hz: 0.015 g <sup>2</sup> Hz (flat)		
	40 Hz to 500 Hz: 0.015 g <sup>2</sup> Hz sloping down to 0.00015 g <sup>2</sup> Hz		

## 2.15 Regulatory Compliance

This section describes the D850GB board's compliance with safety and EMC regulations.

### 2.15.1 Safety Regulations

Table 55 lists the safety regulations the D850GB board complies with when it is correctly installed in a compatible host system.

**Table 55. Safety Regulations**

Regulation	Title
UL 1950/CSA950, 3 <sup>rd</sup> edition, Dated 07-28-95	Bi-National Standard for Safety of Information Technology Equipment including Electrical Business Equipment. (USA and Canada)
EN 60950, 2 <sup>nd</sup> Edition, 1992 (with Amendments 1, 2, 3, and 4)	The Standard for Safety of Information Technology Equipment including Electrical Business Equipment. (European Community)
IEC 950, 2 <sup>nd</sup> edition, 1991 (with Amendments 1, 2, 3, and 4)	The Standard for Safety of Information Technology Equipment including Electrical Business Equipment. (International)
EMKO-TSE (74-SEC) 207/94	Summary of Nordic deviations to EN 60950. (Norway, Sweden, Denmark, and Finland)

### 2.15.2 EMC Regulations

Table 56 lists the EMC regulations with which the D850GB board complies when it is correctly installed in a compatible host system.

**Table 56. EMC Regulations**

Regulation	Title
FCC Class B	Title 47 of the Code of Federal Regulations, Parts 2 and 15, Subpart B, pertaining to unintentional radiators. (USA)
CISPR 22, 2 <sup>nd</sup> Edition, 1993 (Class B)	Limits and methods of measurement of Radio Interference Characteristics of Information Technology Equipment. (International)
VCCI Class B (ITE)	Implementation Regulations for Voluntary Control of Radio Interference by Data Processing Equipment and Electronic Office Machines. (Japan)
EN55022 (1994) (Class B)	Limits and methods of measurement of Radio Interference Characteristics of Information Technology Equipment. (Europe)
EN50082-1 (1992)	Generic Immunity Standard; currently compliance is determined via testing to IEC 801-2, -3, and -4. (Europe)
ICES-003 (1997)	Interference-Causing Equipment Standard, Digital Apparatus, Class B (Including CRC c.1374). (Canada)
AS/NZ 3548	Australian Communications Authority (ACA), Standard for Electromagnetic Compatibility.

### 2.15.3 Certification Markings

This printed circuit assembly has the following markings related to product certification:

- UL Joint Recognition Mark: Consists of small c followed by a stylized backward UR and followed by a small US (Component side)
- Manufacturer's recognition mark: Consists of a unique UL recognized manufacturer's logo, along with a flammability rating (94V-0) (Solder side)
- UL File Number for D850GB boards: E139761 (Component side)
- PB Part Number: Intel bare circuit board part number (Solder side) PB A22167-003
- Battery "+ Side Up" marking: located on the component side of the D850GB board in close proximity to the battery holder
- FCC Logo/Declaration: (Solder side)
- ACA (C-Tick) mark: Consists of a unique letter C, with a tick mark; followed by N-232. Located on the component side of the D850GB board and on the shipping container
- CE Mark: (Component side) The CE mark should also be on the shipping container

# 3 Overview of BIOS Features

---

## What This Chapter Contains

- 3.1 Introduction.....81
- 3.2 BIOS Flash Memory Organization .....82
- 3.3 Resource Configuration .....82
- 3.4 System Management BIOS (SMBIOS) .....83
- 3.5 USB Legacy Support .....83
- 3.6 BIOS Updates .....84
- 3.7 Recovering BIOS Data .....85
- 3.8 Boot Options.....86
- 3.9 Fast Booting Systems with Intel® Rapid BIOS Boot.....86
- 3.10 BIOS Security Features .....88

## 3.1 Introduction

The D850GB board uses an Intel/AMI BIOS, which is stored in flash memory and can be updated using a disk-based program. In addition to the BIOS, the flash memory contains the BIOS Setup program, POST, APM, the PCI auto-configuration utility, and Plug and Play support.

The D850GB board supports system BIOS shadowing, allowing the BIOS to execute from 64-bit onboard write-protected system memory.

The BIOS displays a message during POST identifying the type of BIOS and a revision code. The initial production BIOS is identified as GB85010A.86A.

---

<b>For information about</b>	<b>Refer to</b>
------------------------------	-----------------

The D850GB board's compliance level with APM and Plug and Play
--

Section 1.3, page 16
----------------------

---

## 3.2 BIOS Flash Memory Organization

The Intel 82802AB Firmware Hub (FWH) includes a 4 Mbit (512 KB) symmetrical flash memory device. Internally, the device is grouped into eight 64-KB blocks that are individually erasable, lockable, and unlockable.

## 3.3 Resource Configuration

### 3.3.1 PCI Autoconfiguration

The BIOS can automatically configure PCI devices. PCI devices may be onboard or add-in cards. Autoconfiguration lets a user insert or remove PCI cards without having to configure the system. When a user turns on the system after adding a PCI card, the BIOS automatically configures interrupts, the I/O space, and other system resources. Any interrupts set to Available in Setup are considered to be available for use by the add-in card. Autoconfiguration information is stored in ESCD format.

For information about the versions of PCI and Plug and Play supported by the BIOS, see Section 1.3.

### 3.3.2 PCI IDE Support

If you select Auto in the BIOS Setup program, the BIOS automatically sets up the two PCI IDE connectors with independent I/O channel support. The IDE interface supports hard drives up to Ultra ATA-100 and recognizes any ATAPI compliant devices, including CD-ROM drives, tape drives, and Ultra DMA drives (see Section 1.3 for the supported version of ATAPI). The BIOS determines the capabilities of each drive and configures them to optimize capacity and performance. To take advantage of the high capacities typically available today, hard drives are automatically configured for Logical Block Addressing (LBA) and to PIO Mode 3 or 4, depending on the capability of the drive. You can override the auto-configuration options by specifying manual configuration in the BIOS Setup program.

To use Ultra ATA-66/100 features the following items are required:

- An Ultra ATA-66/100 peripheral device
- An Ultra ATA-66/100 compatible cable
- Ultra ATA-66/100 operating system device drivers

#### ⇒ NOTE

*Ultra ATA-66/100 compatible cables are backward compatible with drives using slower IDE transfer protocols. If an Ultra ATA-66/100 disk drive and a disk drive using any other IDE transfer protocol are attached to the same cable, the maximum transfer rate between the drives is reduced to that of the slowest device.*

#### ⇒ NOTE

*Do not connect an ATA device as a slave on the same IDE cable as an ATAPI master device. For example, do not connect an ATA hard drive as a slave to an ATAPI CD-ROM drive.*

## 3.4 System Management BIOS (SMBIOS)

SMBIOS is a Desktop Management Interface (DMI) compliant method for managing computers in a managed network.

The main component of SMBIOS is the management information format (MIF) database, which contains information about the computing system and its components. Using SMBIOS, a system administrator can obtain the system types, capabilities, operational status, and installation dates for system components. The MIF database defines the data and provides the method for accessing this information. The BIOS enables applications such as third-party management software to use SMBIOS. The BIOS stores and reports the following SMBIOS information:

- BIOS data, such as the BIOS revision level
- Fixed-system data, such as peripherals, serial numbers, and asset tags
- Resource data, such as memory size, cache size, and processor speed
- Dynamic data, such as event detection and error logging

Non-Plug and Play operating systems, such as Windows NT<sup>†</sup>, require an additional interface for obtaining the SMBIOS information. The BIOS supports an SMBIOS table interface for such operating systems. Using this support, an SMBIOS service-level application running on a non-Plug and Play operating system can obtain the SMBIOS information.

### For information about

The D850GB board's compliance level with SMBIOS

### Refer to

Section 1.3, page 16

## 3.5 USB Legacy Support

USB legacy support enables USB devices such as keyboards, mice, and hubs to be used even when the operating system's USB drivers are not yet available. USB legacy support is used to access the BIOS Setup program, and to install an operating system that supports USB. By default, USB legacy support is set to Enabled.

USB legacy support operates as follows:

1. When you apply power to the computer, legacy support is disabled.
2. POST begins.
3. USB legacy support is enabled by the BIOS allowing you to use a USB keyboard to enter and configure the BIOS Setup program and the maintenance menu.
4. POST completes.
5. The operating system loads. While the operating system is loading, USB keyboards and mice are recognized and may be used to configure the operating system. (Keyboards and mice are not recognized during this period if USB legacy support was set to Disabled in the BIOS Setup program.)
6. After the operating system loads the USB drivers, all legacy and non-legacy USB devices are recognized by the operating system, and USB legacy support from the BIOS is no longer used.

To install an operating system that supports USB, verify that USB Legacy support in the BIOS Setup program is set to Enabled and follow the operating system's installation instructions.

⇒ **NOTE**

*USB legacy support is for keyboards, mice, and hubs only. Other USB devices are not supported in legacy mode.*

## 3.6 BIOS Updates

The BIOS can be updated using either of the following utilities, which are available on the Intel World Wide Web site:

- Intel® Express BIOS Update utility, which enables automated updating while in the Windows environment. Using this utility, the BIOS can be updated from a file on a hard disk, a 1.44 MB diskette, or a CD-ROM, or from the file location on the Web.
- Intel® Flash Memory Update Utility, which requires creation of a boot diskette and manual rebooting of the system. Using this utility, the BIOS can be updated from a file on a 1.44 MB diskette (from a legacy diskette drive or an LS-120 diskette drive) or a CD-ROM.

Both utilities support the following BIOS maintenance functions:

- Verifying that the updated BIOS matches the target system to prevent accidentally installing an incompatible BIOS.
- Updating both the BIOS boot block and the main BIOS. This process is fault tolerant to prevent boot block corruption.
- Updating the BIOS boot block separately.
- Changing the language section of the BIOS.
- Updating replaceable BIOS modules, such as the video BIOS module.
- Inserting a custom splash screen.

⇒ **NOTE**

*Review the instructions distributed with the upgrade utility before attempting a BIOS update.*

<b>For information about</b>	<b>Refer to</b>
The Intel World Wide Web site	Section 1.2, page 16

### 3.6.1 Language Support

The BIOS Setup program and help messages are supported in five languages: US English, German, Italian, French, and Spanish. The default language is US English, which is present unless another language is selected in the BIOS Setup program.

### 3.6.2 Custom Splash Screen

During POST, an Intel splash screen is displayed by default. This splash screen can be replaced with a custom splash screen. A utility is available from Intel to assist with creating a custom splash screen. The custom splash screen can be programmed into the flash memory using the BIOS upgrade utility. Information about this capability is available on the Intel Support World Wide Web site. See Section 1.2 for more information about this site.

## 3.7 Recovering BIOS Data

Some types of failure can destroy the BIOS. For example, the data can be lost if a power outage occurs while the BIOS is being updated in flash memory. The BIOS can be recovered from a diskette using the BIOS recovery mode. When recovering the BIOS, be aware of the following:

- Because of the small amount of code available in the non-erasable boot block area, there is no video support. You can only monitor this procedure by listening to the speaker or looking at the diskette drive LED.
- The recovery process may take several minutes; larger BIOS flash memory devices require more time.
- Two beeps and the end of activity in the diskette drive indicate successful BIOS recovery.
- A series of continuous beeps indicates a failed BIOS recovery.

To create a BIOS recovery diskette, a bootable diskette must be created and the BIOS update files copied to it. BIOS upgrades and the Intel Flash Memory Upgrade Utility are available from Intel Customer Support through the Intel World Wide Web site.

#### ⇒ NOTE

*Even if the computer is configured to boot from an LS-120 diskette (in the Setup program's Removable Devices submenu), the BIOS recovery diskette must be a standard 1.44 MB diskette not a 120 MB diskette.*

For information about	Refer to
The BIOS recovery mode jumper settings	Section 2.9.1, page 70
The Boot menu in the BIOS Setup program	Section 4.7, page 106
Contacting Intel customer support	Section 1.2, page 16

## 3.8 Boot Options

In the BIOS Setup program, the user can choose to boot from a diskette drive, hard drives, CD-ROM, or the network. The default setting is for the diskette drive to be the first boot device, the hard drive second, and the ATAPI CD-ROM third. The fourth device is disabled.

### 3.8.1 CD-ROM and Network Boot

Bootting from CD-ROM is supported in compliance to the El Torito bootable CD-ROM format specification. Under the Boot menu in the BIOS Setup program, ATAPI CD-ROM is listed as a boot device. Boot devices are defined in priority order. Accordingly, if there is not a bootable CD in the CD-ROM drive, the system will attempt to boot to the next defined drive.

The network can be selected as a boot device. This selection allows booting from the onboard LAN or a network add-in card with a remote boot ROM installed.

For information about	Refer to
The El Torito specification	Section 1.3, page 16

### 3.8.2 Booting Without Attached Devices

For use in embedded applications, the BIOS has been designed so that after passing the POST, the operating system loader is invoked even if the following devices are not present:

- Video adapter
- Keyboard
- Mouse

## 3.9 Fast Booting Systems with Intel® Rapid BIOS Boot

Three factors affect system boot speed:

- Selecting and configuring peripherals properly
- Using an optimized BIOS, such as the Intel® Rapid BIOS
- Selecting a compatible operating system

### 3.9.1 Peripheral Selection and Configuration

The following techniques help improve system boot speed:

- Choose a hard drive with parameters such as “power-up to data ready” less than eight seconds, that minimize hard drive startup delays.
- Select a CD-ROM drive with a fast initialization rate. This rate can influence POST execution time.
- Eliminate unnecessary add-in adapter features, such as logo displays, screen repaints, or mode changes in POST. These features may add time to the boot process.
- Try different monitors. Some monitors initialize and communicate with the BIOS more quickly, which enables the system to boot more quickly.

### 3.9.2 Intel Rapid BIOS Boot

Use of the following BIOS Setup program settings reduces the POST execution time.

In the Boot Menu:

- Set the hard disk drive as the first boot device. As a result, the POST does not first seek a diskette drive, which saves about one second from the POST execution time.
- Disable Quiet Boot, which eliminates display of the logo splash screen. This could save several seconds of painting complex graphic images and changing video modes.
- Enabled Intel Rapid BIOS Boot. This feature bypasses memory count and the search for a diskette drive

In the Peripheral Configuration submenu, disable the LAN device if it will not be used. This can reduce up to four seconds of option ROM boot time.

#### ⇒ NOTE

*It is possible to optimize the boot process to the point where the system boots so quickly that the Intel logo screen (or a custom logo splash screen) will not be seen. Monitors and hard disk drives with minimum initialization times can also contribute to a boot time that might be so fast that necessary logo screens and POST messages cannot be seen.*

*This boot time may be so fast that some drives might be not be initialized at all. If this condition should occur, it is possible to introduce a programmable delay ranging from 3 to 30 seconds (using the Hard Disk Pre-Delay feature of the Advanced Menu in the IDE Configuration Submenu of the BIOS Setup Program).*

For information about	Refer to
IDE Configuration Submenu in the BIOS Setup Program	Section 4.4.4, page 98

### 3.9.3 Operating System

The Microsoft Windows Millennium Edition (Windows Me) operating system has built-in capabilities for making PCs boot more quickly. To speed operating system availability at boot time, limit the number of applications that load into the system tray or the task bar.

## 3.10 BIOS Security Features

The BIOS includes security features that restrict access to the BIOS Setup program and who can boot the computer. A supervisor password and a user password can be set for the BIOS Setup program and for booting the computer, with the following restrictions:

- The supervisor password gives unrestricted access to view and change all the Setup options in the BIOS Setup program. This is the supervisor mode.
- The user password gives restricted access to view and change Setup options in the BIOS Setup program. This is the user mode.
- If only the supervisor password is set, pressing the <Enter> key at the password prompt of the BIOS Setup program allows the user restricted access to Setup.
- If both the supervisor and user passwords are set, users can enter either the supervisor password or the user password to access Setup. Users have access to Setup respective to which password is entered.
- Setting the user password restricts who can boot the computer. The password prompt will be displayed before the computer is booted. If only the supervisor password is set, the computer boots without asking for a password. If both passwords are set, the user can enter either password to boot the computer.

Table 57 shows the effects of setting the supervisor password and user password. This table is for reference only and is not displayed on the screen.

**Table 57. Supervisor and User Password Functions**

Password Set	Supervisor Mode	User Mode	Setup Options	Password to Enter Setup	Password During Boot
Neither	Can change all options <small>(Note)</small>	Can change all options <small>(Note)</small>	None	None	None
Supervisor only	Can change all options	Can change a limited number of options	Supervisor Password	Supervisor	None
User only	N/A	Can change all options	Enter Password Clear User Password	User	User
Supervisor and user set	Can change all options	Can change a limited number of options	Supervisor Password Enter Password	Supervisor or user	Supervisor or user

Note: If no password is set, any user can change all Setup options.

### For information about

Setting user and supervisor passwords

### Refer to

Section 4.5, page 104

# 4 BIOS Setup Program

## What This Chapter Contains

4.1	Introduction.....	89
4.2	Maintenance Menu .....	90
4.3	Main Menu.....	92
4.4	Advanced Menu.....	93
4.5	Security Menu .....	104
4.6	Power Menu .....	105
4.7	Boot Menu .....	106
4.8	Exit Menu .....	108

### 4.1 Introduction

The BIOS Setup program can be used to view and change the BIOS settings for the computer. The BIOS Setup program is accessed by pressing the <F2> key after the Power-On Self-Test (POST) memory test begins and before the operating system boot begins. The menu bar is shown below.

Maintenance	Main	Advanced	Security	Power	Boot	Exit
-------------	------	----------	----------	-------	------	------

Table 58 lists the BIOS Setup program menu features.

**Table 58. BIOS Setup Program Menu Bar**

Maintenance	Main	Advanced	Security	Power	Boot	Exit
Clears passwords and BIS credentials and enables extended configuration mode	Allocates resources for hardware components	Configures advanced features available through the chipset	Sets passwords and security features	Configures power management features	Selects boot options and power supply controls	Saves or discards changes to Setup program options

**For information about**

Boot Integrity Services (BIS)

**Refer to**

Section 1.3, page 16

**⇒ NOTE**

*In this chapter, all examples of the BIOS Setup Program menu bar include the maintenance menu; however, the maintenance menu is displayed only when the board is in configuration mode. Section 2.9 on page 69 tells how to put the board in configuration mode.*

Table 59 lists the function keys available for menu screens.

**Table 59. BIOS Setup Program Function Keys**

BIOS Setup Program Function Key	Description
<←> or <→>	Selects a different menu screen (Moves the cursor left or right)
<↑> or <↓>	Selects an item (Moves the cursor up or down)
<Tab>	Selects a field (Not implemented)
<Enter>	Executes command or selects the submenu
<F9>	Load the default configuration values for the current menu
<F10>	Save the current values and exits the BIOS Setup program
<Esc>	Exits the menu

## 4.2 Maintenance Menu

To access this menu, select Maintenance on the menu bar at the top of the screen.

<b>Maintenance</b>	Main	Advanced	Security	Power	Boot	Exit
Extended Configuration						

The menu shown in Table 60 is for clearing Setup passwords and enabling extended configuration mode. Setup only displays this menu in configuration mode. See Section 2.9 on page 69 for configuration mode setting information.

**Table 60. Maintenance Menu**

Feature	Options	Description
Processor Speed	Processor dependent	Displays the processor speed.
Clear All Passwords	<ul style="list-style-type: none"> <li>• <b>Yes (default)</b></li> <li>• No</li> </ul>	Clears the user and supervisor passwords.
Clear BIS Credentials	<ul style="list-style-type: none"> <li>• <b>Yes (default)</b></li> <li>• No</li> </ul>	Clears the Wired for Management Boot Integrity Service (BIS) credentials.
Extended Configuration	<ul style="list-style-type: none"> <li>• <b>Default (default)</b></li> <li>• User-Defined</li> </ul>	Invokes the Extended Configuration submenu.
CPU Information	No options	Displays CPU Information.
CPU Stepping Signature	No options	Displays CPU's Stepping Signature.
CPU Microcode Update Revision	No options	Displays CPU's Microcode Update Revision.

## 4.2.1 Extended Configuration Submenu

To access this submenu, select Maintenance on the menu bar, then Extended Configuration.

<b>Maintenance</b>	Main	Advanced	Security	Power	Boot	Exit
<b>Extended Configuration</b>						

The submenu represented by Table 61 is for setting video memory cache mode. This submenu becomes available when User Defined is selected under Extended Configuration.

**Table 61. Extended Configuration Submenu**

Feature	Options	Description
Extended Configuration	<ul style="list-style-type: none"> <li><b>Default (default)</b></li> <li>User Defined</li> </ul>	User Defined allows setting memory control and video memory cache mode. If selected here, will also display in the Advanced Menu as: "Extended Menu: <i>Used.</i> "
Video Memory Cache Mode	<ul style="list-style-type: none"> <li>USWC</li> <li><b>UC (default)</b></li> </ul>	<p>Selects Uncacheable Speculative Write-Combining (USWC) video memory cache mode. Full 32 byte contents of the Write Combining buffer are written to memory as required. Cache lookups are not performed. Both the video driver and the application must support Write Combining.</p> <p>Selects UnCacheable (UC) video memory cache mode. This setting identifies the video memory range as uncacheable by the processor. Memory writes are performed in program order. Cache lookups are not performed. Well suited for applications not supporting Write Combining.</p>

## 4.3 Main Menu

To access this menu, select Main on the menu bar at the top of the screen.

Maintenance	<b>Main</b>	Advanced	Security	Power	Boot	Exit
-------------	-------------	----------	----------	-------	------	------

Table 62 describes the Main menu. This menu reports processor and memory information and is for configuring the system date and system time.

**Table 62. Main Menu**

Feature	Options	Description
BIOS Version	No options	Displays the version of the BIOS.
Processor Type	No options	Displays processor type.
Processor Speed	No options	Displays processor speed.
System Bus Frequency	No options	Displays the system bus frequency.
Cache RAM	No options	Displays the size of second-level cache and whether it is ECC-capable.
Total Memory	No options	Displays the total amount of RAM.
RIMM 1 RIMM 2 RIMM 3 RIMM 4	No options	Displays the amount and type of RAM in the memory banks.
Language	<ul style="list-style-type: none"> <li>• <b>English (default)</b></li> <li>• Español</li> <li>• Deutsch</li> <li>• Italiano</li> <li>• Français</li> </ul>	Selects the current default language used by the BIOS.
Memory Configuration	<ul style="list-style-type: none"> <li>• Non-ECC</li> <li>• <b>ECC (default)</b></li> </ul>	Allows the user to enable error reporting if the system and all installed memory supports ECC. If non-ECC memory is installed, BIOS will detect and change setting to non-ECC.
System Time	Hour, minute, and second	Specifies the current time.
System Date	Day of week Month/day/year	Specifies the current date.

## 4.4 Advanced Menu

To access this menu, select Advanced on the menu bar at the top of the screen.

Maintenance	Main	<b>Advanced</b>	Security	Power	Boot	Exit
		PCI Configuration				
		Boot Configuration				
		Peripheral Configuration				
		IDE Configuration				
		Diskette Configuration				
		Event Log Configuration				
		Video Configuration				

Table 63 describes the Advanced Menu. This menu is used for setting advanced features that are available through the chipset.

**Table 63. Advanced Menu**

Feature	Options	Description
Extended Configuration	No options	If <i>Used</i> is displayed, <i>User-Defined</i> has been selected in Extended Configuration under the Maintenance Menu.
PCI Configuration	Select to display submenu	Configures individual PCI slot's IRQ priority. When selected, displays the PCI Configuration submenu.
Boot Configuration	Select to display submenu	Configures Plug and Play and the Numlock key, and resets configuration data. When selected, displays the Boot Configuration submenu.
Peripheral Configuration	Select to display submenu	Configures peripheral ports and devices. When selected, displays the Peripheral Configuration submenu.
IDE Configuration	Select to display submenu	Specifies type of connected IDE devices.
Diskette Configuration	Select to display submenu	When selected, displays the Diskette Configuration submenu.
Event Log Configuration	Select to display submenu	Configures Event Logging. When selected, displays the Event Log Configuration submenu.
Video Configuration	Select to display submenu	Configures video features. When selected, displays the Video Configuration submenu.

### 4.4.1 PCI Configuration Submenu

To access this submenu, select Advanced on the menu bar, then PCI Configuration.

Maintenance	Main	<b>Advanced</b>	Security	Power	Boot	Exit
		<b>PCI Configuration</b>				
		Boot Configuration				
		Peripheral Configuration				
		IDE Configuration				
		Diskette Configuration				
		Event Log Configuration				
		Video Configuration				

The submenu represented by Table 64 is for configuring the IRQ priority of PCI slots individually.

**Table 64. PCI Configuration Submenu**

Feature	Options	Description
PCI Slot 1 IRQ Priority	<ul style="list-style-type: none"> <li>• <b>Auto (default)</b></li> <li>3</li> <li>5</li> <li>9</li> <li>10</li> <li>11</li> </ul>	Allows selection of IRQ priority.
PCI Slot 2 IRQ Priority	<ul style="list-style-type: none"> <li>• <b>Auto (default)</b></li> <li>3</li> <li>5</li> <li>9</li> <li>10</li> <li>11</li> </ul>	Allows selection of IRQ priority.
PCI Slot 3 IRQ Priority	<ul style="list-style-type: none"> <li>• <b>Auto (default)</b></li> <li>3</li> <li>5</li> <li>9</li> <li>10</li> <li>11</li> </ul>	Allows selection of IRQ priority.
PCI Slot 4 IRQ Priority	<ul style="list-style-type: none"> <li>• <b>Auto (default)</b></li> <li>3</li> <li>5</li> <li>9</li> <li>10</li> <li>11</li> </ul>	Allows selection of IRQ priority.
PCI Slot 5 IRQ Priority	No options	Always set to Auto.

## 4.4.2 Boot Configuration Submenu

To access this submenu, select Advanced on the menu bar, then Boot Configuration.

Maintenance	Main	<b>Advanced</b>	Security	Power	Boot	Exit
		PCI Configuration				
		<b>Boot Configuration</b>				
		Peripheral Configuration				
		IDE Configuration				
		Diskette Configuration				
		Event Log Configuration				
		Video Configuration				

The submenu represented by Table 65 is for setting Plug and Play options, resetting configuration data, and the power-on state of the Numlock key.

**Table 65. Boot Configuration Submenu**

Feature	Options	Description
Plug & Play O/S	<ul style="list-style-type: none"> <li>• <b>No (default)</b></li> <li>• Yes</li> </ul>	<p>Specifies if manual configuration is desired.</p> <p><i>No</i> lets the BIOS configure all devices. This setting is appropriate when using a Plug and Play operating system.</p> <p><i>Yes</i> lets the operating system configure Plug and Play devices not required to boot the system. This option is available for use during lab testing.</p>
Reset Config Data	<ul style="list-style-type: none"> <li>• <b>No (default)</b></li> <li>• Yes</li> </ul>	<p><i>No</i> does not clear the PCI/PnP configuration data stored in flash memory on the next boot.</p> <p><i>Yes</i> clears the PCI/PnP configuration data stored in flash memory on the next boot.</p>
Numlock	<ul style="list-style-type: none"> <li>• Off</li> <li>• <b>On (default)</b></li> </ul>	<p>Specifies the power-on state of the Numlock feature on the numeric keypad of the keyboard.</p>

### 4.4.3 Peripheral Configuration Submenu

To access this submenu, select Advanced on the menu bar, then Peripheral Configuration.

Maintenance	Main	<b>Advanced</b>	Security	Power	Boot	Exit
		PCI Configuration				
		Boot Configuration				
		<b>Peripheral Configuration</b>				
		IDE Configuration				
		Diskette Configuration				
		Event Log Configuration				
		Video Configuration				

The submenu represented in Table 66 is used for configuring computer peripherals.

**Table 66. Peripheral Configuration Submenu**

Feature	Options	Description
Serial port A	<ul style="list-style-type: none"> <li>Disabled</li> <li>Enabled</li> <li><b>Auto (default)</b></li> </ul>	Configures serial port A. <i>Auto</i> assigns the first free COM port, normally COM1, the address 3F8h, and the interrupt IRQ4. An * (asterisk) displayed next to an address indicates a conflict with another device.
Base I/O address (This feature is present only when Serial Port A is set to <i>Enabled</i> )	<ul style="list-style-type: none"> <li><b>3F8 (default)</b></li> <li>2F8</li> <li>3E8</li> <li>2E8</li> </ul>	Specifies the base I/O address for serial port A, if serial port A is Enabled.
Interrupt (This feature is present only when Serial Port A is set to <i>Enabled</i> )	<ul style="list-style-type: none"> <li>IRQ 3</li> <li><b>IRQ 4 (default)</b></li> </ul>	Specifies the interrupt for serial port A, if serial port A is Enabled.
Parallel port	<ul style="list-style-type: none"> <li>Disabled</li> <li>Enabled</li> <li><b>Auto (default)</b></li> </ul>	Configures the parallel port. <i>Auto</i> assigns LPT1 the address 378h and the interrupt IRQ7. An * (asterisk) displayed next to an address indicates a conflict with another device.
Mode	<ul style="list-style-type: none"> <li>Output Only</li> <li><b>Bi-directional (default)</b></li> <li>EPP</li> <li>ECP</li> </ul>	Selects the mode for the parallel port. Not available if the parallel port is disabled. <i>Output Only</i> operates in AT <sup>†</sup> -compatible mode. <i>Bi-directional</i> operates in PS/2-compatible mode. <i>EPP</i> is Extended Parallel Port mode, a high-speed bi-directional mode. <i>ECP</i> is Enhanced Capabilities Port mode, a high-speed bi-directional mode.

continued

**Table 66. Peripheral Configuration Submenu** (continued)

Feature	Options	Description
Base I/O address (This feature is present only when Parallel Port is set to <i>Enabled</i> )	<ul style="list-style-type: none"> <li>• <b>378 (default)</b></li> <li>• 278</li> </ul>	Specifies the base I/O address for the parallel port.
Interrupt (This feature is present only when Parallel Port is set to <i>Enabled</i> )	<ul style="list-style-type: none"> <li>• IRQ 5</li> <li>• <b>IRQ 7 (default)</b></li> </ul>	Specifies the interrupt for the parallel port.
DMA (This feature is present only when Parallel Port Mode is set to <i>ECP</i> )	<ul style="list-style-type: none"> <li>• 1</li> <li>• <b>3 (default)</b></li> </ul>	Specifies the DMA channel.
Audio Device	<ul style="list-style-type: none"> <li>• Disabled</li> <li>• <b>Enabled (default)</b></li> </ul>	Enables or disables the onboard audio subsystem.
LAN Device	<ul style="list-style-type: none"> <li>• Disabled</li> <li>• <b>Enabled (default)</b></li> </ul>	Enables or disables the LAN device.
Legacy USB Support	<ul style="list-style-type: none"> <li>• Disabled</li> <li>• <b>Enabled (default)</b></li> </ul>	Enables or disables USB legacy support. (See Section 3.5 on page 83 for more information.)

#### 4.4.4 IDE Configuration Submenu

To access this submenu, select Advanced on the menu bar, then IDE Configuration.

Maintenance	Main	<b>Advanced</b>	Security	Power	Boot	Exit
		PCI Configuration				
		Boot Configuration				
		Peripheral Configuration				
		<b>IDE Configuration</b>				
		Diskette Configuration				
		Event Log Configuration				
		Video Configuration				

The menu represented in Table 67 is used to configure IDE device options.

**Table 67. IDE Configuration Submenu**

Feature	Options	Description
IDE Controller	<ul style="list-style-type: none"> <li>• Disabled</li> <li>• Primary</li> <li>• Secondary</li> <li>• <b>Both (default)</b></li> </ul>	Specifies the integrated IDE controller. <i>Primary</i> enables only the primary IDE controller. <i>Secondary</i> enables only the secondary IDE controller. <i>Both</i> enables both IDE controllers.
Hard Disk Pre-Delay	<ul style="list-style-type: none"> <li>• <b>Disabled (default)</b></li> <li>• 3 Seconds</li> <li>• 6 Seconds</li> <li>• 9 Seconds</li> <li>• 12 Seconds</li> <li>• 15 Seconds</li> <li>• 21 Seconds</li> <li>• 30 Seconds</li> </ul>	Specifies the hard disk drive pre-delay.
Primary IDE Master	Select to display submenu	Reports type of connected IDE device. When selected, displays the Primary IDE Master submenu.
Primary IDE Slave	Select to display submenu	Reports type of connected IDE device. When selected, displays the Primary IDE Slave submenu.
Secondary IDE Master	Select to display submenu	Reports type of connected IDE device. When selected, displays the Secondary IDE Master submenu.
Secondary IDE Slave	Select to display submenu	Reports type of connected IDE device. When selected, displays the Secondary IDE Slave submenu.

#### 4.4.4.1 Primary/Secondary IDE Master/Slave Submenus

To access these submenus, select Advanced on the menu bar, then IDE Configuration and then the master or slave to be configured.

Maintenance	Main	<b>Advanced</b>	Security	Power	Boot	Exit
		PCI Configuration				
		Boot Configuration				
		Peripheral Configuration				
		<b>IDE Configuration</b>				
		<b>Primary IDE Master</b>				
		<b>Primary IDE Slave</b>				
		<b>Secondary IDE Master</b>				
		<b>Secondary IDE Slave</b>				
		Diskette Configuration				
		Event Log Configuration				
		Video Configuration				

There are four IDE submenus: primary master, primary slave, secondary master, and secondary slave. Table 68 shows the format of the IDE submenus. For brevity, only one example is shown.

**Table 68. Primary/Secondary IDE Master/Slave Submenus**

Feature	Options	Description
Drive Installed	No options	Displays the type of drive installed.
Type	<ul style="list-style-type: none"> <li>• None</li> <li>• User</li> <li>• <b>Auto (default)</b></li> <li>• CD-ROM</li> <li>• ATAPI Removable</li> <li>• Other ATAPI</li> <li>• IDE Removable</li> </ul>	<p>Specifies the IDE configuration mode for IDE devices.</p> <p><i>User</i> allows capabilities to be changed.</p> <p><i>Auto</i> fills-in capabilities from ATA/ATAPI device.</p>
Maximum Capacity	No options	Displays the capacity of the drive.
LBA Mode Control	<ul style="list-style-type: none"> <li>• Disabled</li> <li>• <b>Enabled (default)</b></li> </ul>	Enables or disables LBA mode control.
Multi-Sector Transfers	<ul style="list-style-type: none"> <li>• Disabled</li> <li>• 2 Sectors</li> <li>• 4 Sectors</li> <li>• 8 Sectors</li> <li>• <b>16 Sectors (default)</b></li> </ul>	<p>Specifies number of sectors per block for transfers from the hard disk drive to memory.</p> <p>Check the hard disk drive's specifications for optimum setting.</p>

continued

**Table 68. Primary/Secondary IDE Master/Slave Submenus** (continued)

Feature	Options	Description
PIO Mode	<ul style="list-style-type: none"> <li>• <b>Auto (default)</b></li> <li>• 0</li> <li>• 1</li> <li>• 2</li> <li>• 3</li> <li>• 4</li> </ul>	Specifies the PIO mode.
Ultra DMA	<ul style="list-style-type: none"> <li>• <b>Disabled (default)</b></li> <li>• Mode 0</li> <li>• Mode 1</li> <li>• Mode 2</li> <li>• Mode 3</li> <li>• Mode 4</li> </ul>	Specifies the Ultra DMA mode for the drive.
Cable Detected	No options	Displays the type of cable connected to the IDE interface: 40-conductor or 80-conductor (for Ultra ATA-100 devices).
Use ARMD Drive as	<ul style="list-style-type: none"> <li>• <b>Floppy (default)</b></li> <li>• Hard Disk</li> </ul>	Selects how the ARMD drive will be used.

#### 4.4.5 Diskette Configuration Submenu

To access this menu, select Advanced on the menu bar, then Diskette Configuration.

Maintenance	Main	<b>Advanced</b>	Security	Power	Boot	Exit
		PCI Configuration				
		Boot Configuration				
		Peripheral Configuration				
		IDE Configuration				
		<b>Diskette Configuration</b>				
		Event Log Configuration				
		Video Configuration				

The submenu represented by Table 69 is used for configuring the diskette drive.

**Table 69. Diskette Configuration Submenu**

Feature	Options	Description
Diskette Controller	<ul style="list-style-type: none"> <li>Disabled</li> <li><b>Enabled (default)</b></li> </ul>	Disables or enables the integrated diskette controller.
Floppy A	<ul style="list-style-type: none"> <li>Not Installed</li> <li>360 KB      5¼"</li> <li>1.2 MB      5¼"</li> <li>720 KB      3½"</li> <li><b>1.44/1.25 MB    3½" (default)</b></li> <li>2.88 MB      3½"</li> </ul>	Specifies the capacity and physical size of diskette drive A.
Diskette Write-Protect	<ul style="list-style-type: none"> <li><b>Disabled (default)</b></li> <li>Enabled</li> </ul>	Disables or enables write-protect for the diskette drive.

#### 4.4.6 Event Log Configuration Submenu

To access this menu, select Advanced on the menu bar, then Event Log Configuration.

Maintenance	Main	<b>Advanced</b>	Security	Power	Boot	Exit
		PCI Configuration				
		Boot Configuration				
		Peripheral Configuration				
		IDE Configuration				
		Diskette Configuration				
		<b>Event Log Configuration</b>				
		Video Configuration				

The submenu represented by Table 70 is used to configure the event logging features.

**Table 70. Event Log Configuration Submenu**

Feature	Options	Description
Event log	No options	Indicates if there is space available in the event log.
Event log validity	No options	Indicates if the contents of the event log are valid.
View event log	[Enter]	Displays the event log.
Clear all event logs	<ul style="list-style-type: none"> <li>• <b>No (default)</b></li> <li>• Yes</li> </ul>	Clears the event log after rebooting.
Event Logging	<ul style="list-style-type: none"> <li>• Disabled</li> <li>• <b>Enabled (default)</b></li> </ul>	Enables logging of events.
ECC Event Logging	<ul style="list-style-type: none"> <li>• Disabled</li> <li>• <b>Enabled (default)</b></li> </ul>	Enables logging of ECC events.
Mark events as read	[Enter]	Marks all events as read.

#### 4.4.7 Video Configuration Submenu

To access this menu, select Advanced on the menu bar, then Video Configuration.

Maintenance	Main	<b>Advanced</b>	Security	Power	Boot	Exit
		PCI Configuration				
		Boot Configuration				
		Peripheral Configuration				
		IDE Configuration				
		Diskette Configuration				
		Event Log Configuration				
		<b>Video Configuration</b>				

The submenu represented in Table 71 is for configuring the video features.

**Table 71. Video Configuration Submenu**

Feature	Options	Description
AGP Aperture Size	<ul style="list-style-type: none"> <li>• <b>64 MB (default)</b></li> <li>• 256 MB</li> </ul>	Sets the aperture size for the AGP video controller.
Primary Video Adapter	<ul style="list-style-type: none"> <li>• <b>AGP (default)</b></li> <li>• PCI</li> </ul>	Selects primary video adapter to be used during boot.

## 4.5 Security Menu

To access this menu, select Security from the menu bar at the top of the screen.

Maintenance	Main	Advanced	<b>Security</b>	Power	Boot	Exit
-------------	------	----------	-----------------	-------	------	------

The menu represented by Table 72 is for setting passwords and security features.

**Table 72. Security Menu**

If no password entered previously:		
Feature	Options	Description
Supervisor Password Is	No options	Reports if there is a supervisor password set.
User Password Is	No options	Reports if there is a user password set.
Set Supervisor Password	Password can be up to seven alphanumeric characters.	Specifies the supervisor password.
Set User Password	Password can be up to seven alphanumeric characters.	Specifies the user password.
Clear User Password (Note 1)	<ul style="list-style-type: none"> <li>• <b>Yes (default)</b></li> <li>• No</li> </ul>	Clears the user password.
User Access Level (Note 2)	<ul style="list-style-type: none"> <li>• Limited</li> <li>• No Access</li> <li>• View Only</li> <li>• <b>Full (default)</b></li> </ul>	Sets BIOS Setup Utility access rights for user level.
Unattended Start (Note 1)	<ul style="list-style-type: none"> <li>• <b>Disabled (default)</b></li> <li>• Enabled</li> </ul>	Enabled allows system to complete the boot process without a password. The keyboard remains locked until a password is entered. A password is required to boot from a diskette.

Notes:

1. This feature appears only if a user password has been set.
2. This feature appears only if a supervisor password has been set.

## 4.6 Power Menu

To access this menu, select Power from the menu bar at the top of the screen.

Maintenance	Main	Advanced	Security	<b>Power</b>	Boot	Exit
-------------	------	----------	----------	--------------	------	------

The menu represented in Table 73 is for setting the power management features.

**Table 73. Power Menu**

Feature	Options	Description
Power Management	<ul style="list-style-type: none"> <li>• Disabled</li> <li>• <b>Enabled (default)</b></li> </ul>	Enables or disables the BIOS power management feature.
Inactivity Timer	<ul style="list-style-type: none"> <li>• Off</li> <li>• 1 Minute</li> <li>• 5 Minutes</li> <li>• 10 Minutes</li> <li>• <b>20 Minutes (default)</b></li> <li>• 30 Minutes</li> <li>• 60 Minutes</li> <li>• 120 Minutes</li> </ul>	Specifies the amount of time before the computer enters standby mode.
Hard Drive	<ul style="list-style-type: none"> <li>• Disabled</li> <li>• <b>Enabled (default)</b></li> </ul>	Enables power management for hard disks during standby modes.
ACPI Suspend State	<ul style="list-style-type: none"> <li>• <b>S1 State (default)</b></li> <li>• S3 State</li> </ul>	Specifies the ACPI suspend state.

## 4.7 Boot Menu

To access this menu, select Boot from the menu bar at the top of the screen.

Maintenance	Main	Advanced	Security	Power	<b>Boot</b>	Exit
						IDE Drive Configuration

The menu represented in Table 74 is used to set the boot features and the boot sequence.

**Table 74. Boot Menu**

Feature	Options	Description
Quiet Boot	<ul style="list-style-type: none"> <li>Disabled</li> <li><b>Enabled (default)</b></li> </ul>	<p><i>Disabled</i> displays normal POST messages.</p> <p><i>Enabled</i> displays OEM graphic instead of POST messages.</p>
Intel Rapid BIOS Boot	<ul style="list-style-type: none"> <li>Disabled</li> <li><b>Enabled (default)</b></li> </ul>	Enables the computer to boot without running certain POST tests.
Scan User Flash Area	<ul style="list-style-type: none"> <li><b>Disabled (default)</b></li> <li>Enabled</li> </ul>	Enables the BIOS to scan the flash memory for user binary files that are executed at boot time.
After Power Failure	<ul style="list-style-type: none"> <li><b>Stay Off (default)</b></li> <li>Last State</li> <li>Power On</li> </ul>	<p>Specifies the mode of operation if an AC power loss occurs.</p> <p><i>Stay Off</i> keeps the power off until the power button is pressed.</p> <p><i>Last State</i> restores the previous power state before power loss occurred.</p> <p><i>Power On</i> restores power to the computer.</p>
On Modem Ring	<ul style="list-style-type: none"> <li><b>Stay Off (default)</b></li> <li>Power On</li> </ul>	In APM mode only, specifies how the computer responds to an incoming call on an installed modem when the power is off.
On LAN	<ul style="list-style-type: none"> <li>Stay Off</li> <li><b>Power On (default)</b></li> </ul>	In APM mode only, determines how the system responds to a LAN wake up event.
On PME	<ul style="list-style-type: none"> <li><b>Stay Off (default)</b></li> <li>Power On</li> </ul>	In APM mode only, determines how the system responds to a PCI power management event.
On ACPI S5	<ul style="list-style-type: none"> <li><b>Stay Off (default)</b></li> <li>Power On</li> </ul>	IN ACPI mode only, determines the action of the system when a LAN wake up event occurs.

continued

**Table 74. Boot Menu** (continued)

Feature	Options	Description
1 <sup>st</sup> Boot Device 2 <sup>nd</sup> Boot Device 3 <sup>rd</sup> Boot Device 4 <sup>th</sup> Boot Device 5 <sup>th</sup> Boot Device	<ul style="list-style-type: none"> <li>• Floppy</li> <li>• ARMD-FDD (Note 1)</li> <li>• ARMD-HDD (Note 2)</li> <li>• IDE-HDD (Note 3)</li> <li>• ATAPI CDROM</li> <li>• Intel UNDI, PXE 2.0 (Note 4)</li> <li>• Disabled</li> </ul>	<p>Specifies the boot sequence according to the device type. The computer will attempt to boot from up to five devices as specified here. Only one of the devices can be an IDE hard disk drive. To specify boot sequence:</p> <ol style="list-style-type: none"> <li>1. Select the boot device with &lt;↑&gt; or &lt;↓&gt;.</li> <li>2. Press &lt;Enter&gt; to set the selection as the intended boot device.</li> </ol> <p>The default settings for the first through fifth boot devices are, respectively:</p> <ul style="list-style-type: none"> <li>• Floppy</li> <li>• IDE-HDD</li> <li>• ATAPI CDROM</li> <li>• Intel UNDI, PXE 2.0</li> <li>• Disabled</li> </ul> <p><b>NOTE:</b> To configure the computer to boot from an IDE hard disk drive, set a boot device in the Setup feature to IDE-HDD. Determine the IDE channel, and master or slave mode of the drive. Then, in the next Setup feature, IDE Drive Configuration, set that channel and mode to 1<sup>st</sup> IDE.</p>
<ul style="list-style-type: none"> <li>▶ IDE Drive Configuration <ul style="list-style-type: none"> <li>Primary Master IDE</li> <li>Primary Slave IDE</li> <li>Secondary Master IDE</li> <li>Secondary Slave IDE</li> </ul> </li> </ul>	<ul style="list-style-type: none"> <li>• <b>1<sup>st</sup> IDE (default)</b></li> <li>• 2<sup>nd</sup> IDE</li> <li>• 3<sup>rd</sup> IDE</li> <li>• 4<sup>th</sup> IDE</li> </ul>	<p>1<sup>st</sup> IDE specifies the IDE hard disk drive to boot from. The 2<sup>nd</sup> through 4<sup>th</sup> IDE settings are ignored. See the note above for more information.</p> <p>To specify the drive to boot from:</p> <ol style="list-style-type: none"> <li>1. Use &lt;↑&gt; or &lt;↓&gt; to select the channel, and master or slave mode of the drive to boot from.</li> <li>2. Press &lt;Enter&gt;.</li> <li>3. Use &lt;↑&gt; or &lt;↓&gt; to select 1<sup>st</sup> IDE.</li> <li>4. Press &lt;Enter&gt; to set the selection.</li> </ol>

## Notes:

- 1 ARMD-FDD = ATAPI removable device - floppy disk drive
- 2 ARMD-HDD = ATAPI removable device - hard disk drive
- 3 HDD = Hard Disk Drive
- 4 This boot device is available only when the onboard LAN subsystem is present.

## 4.8 Exit Menu

To access this menu, select Exit from the menu bar at the top of the screen.

Maintenance	Main	Advanced	Security	Power	Boot	<b>Exit</b>
-------------	------	----------	----------	-------	------	-------------

The menu represented in Table 75 is for exiting the BIOS Setup program, saving changes, and loading and saving defaults.

**Table 75. Exit Menu**

Feature	Description
Exit Saving Changes	Exits and saves the changes in CMOS SRAM.
Exit Discarding Changes	Exits without saving any changes made in the BIOS Setup program.
Load Setup Defaults	Loads the factory default values for all the Setup options.
Load Custom Defaults	Loads the custom defaults for Setup options.
Save Custom Defaults	Saves the current values as custom defaults. Normally, the BIOS reads the Setup values from flash memory. If this memory is corrupted, the BIOS reads the custom defaults. If no custom defaults are set, the BIOS reads the factory defaults.
Discard Changes	Discards changes without exiting Setup. The option values present when the computer was turned on are used.

# 5 Error Messages and Beep Codes

## What This Chapter Contains

- 5.1 BIOS Error Messages.....109
- 5.2 Port 80h POST Codes.....111
- 5.3 Bus Initialization Checkpoints .....115
- 5.4 Speaker.....116
- 5.5 BIOS Beep Codes .....116
- 5.6 Diagnostic LEDs.....118

## 5.1 BIOS Error Messages

Table 76 lists the error messages and provides a brief description of each.

**Table 76. BIOS Error Messages**

<b>Error Message</b>	<b>Explanation</b>
GA20 Error	An error occurred with Gate A20 when switching to protected mode during the memory test.
Pri Master HDD Error Pri Slave HDD Error Sec Master HDD Error Sec Slave HDD Error	Could not read sector from corresponding drive.
Pri Master Drive - ATAPI Incompatible Pri Slave Drive - ATAPI Incompatible Sec Master Drive - ATAPI Incompatible Sec Slave Drive - ATAPI Incompatible	Corresponding drive is not an ATAPI device. Run Setup to make sure device is selected correctly.
A: Drive Error	No response from diskette drive.
Cache Memory Bad	An error occurred when testing L2 cache. Cache memory may be bad.
CMOS Battery Low	The battery may be losing power. Replace the battery soon.
CMOS Display Type Wrong	The display type is different than what has been stored in CMOS. Check Setup to make sure type is correct.
CMOS Checksum Bad	The CMOS checksum is incorrect. CMOS memory may have been corrupted. Run Setup to reset values.
CMOS Settings Wrong	CMOS values are not the same as the last boot. These values have either been corrupted or the battery has failed.
CMOS Date/Time Not Set	The time and/or date values stored in CMOS are invalid. Run Setup to set correct values.
DMA Error	Error during read/write test of DMA controller.
FDC Failure	Error occurred trying to access diskette drive controller.
HDC Failure	Error occurred trying to access hard disk controller.

continued

**Table 76. BIOS Error Messages** (continued)

<b>Error Message</b>	<b>Explanation</b>
Checking NVRAM.....	NVRAM is being checked to see if it is valid.
Update OK!	NVRAM was invalid and has been updated.
Updated Failed	NVRAM was invalid but was unable to be updated.
Keyboard Error	Error in the keyboard connection. Make sure keyboard is connected properly.
KB/Interface Error	Keyboard interface test failed.
Memory Size Decreased	Memory size has decreased since the last boot. If no memory was removed then memory may be bad.
Memory Size Increased	Memory size has increased since the last boot. If no memory was added there may be a problem with the system.
Memory Size Changed	Memory size has changed since the last boot. If no memory was added or removed then memory may be bad.
No Boot Device Available	System did not find a device to boot.
Off Board Parity Error	A parity error occurred on an off-board card. This error is followed by an address.
On Board Parity Error	A parity error occurred in onboard memory. This error is followed by an address.
Parity Error	A parity error occurred in onboard memory at an unknown address.
NVRAM / CMOS / PASSWORD cleared by Jumper	NVRAM, CMOS, and passwords have been cleared. The system should be powered down and the jumper removed.
<CTRL_N> Pressed	CMOS is ignored and NVRAM is cleared. User must enter Setup.

## 5.2 Port 80h POST Codes

During the POST, the BIOS generates diagnostic progress codes (POST-codes) to I/O port 80h. If the POST fails, execution stops and the last POST code generated is left at port 80h. This code is useful for determining the point where an error occurred.

Displaying the POST-codes requires an add-in card, often called a POST card (PCI not ISA). The POST card can decode the port and display the contents on a medium such as a seven-segment display.

The tables below offer descriptions of the POST codes generated by the BIOS. Table 77 defines the uncompressed INIT code checkpoints, Table 78 describes the boot block recovery code checkpoints, and Table 79 lists the runtime code uncompressed in F000 shadow RAM. Some codes are repeated in the tables because that code applies to more than one operation.

**Table 77. Uncompressed INIT Code Checkpoints**

Code	Description of POST Operation
D0	NMI is Disabled. Onboard KBC, RTC enabled (if present). Init code Checksum verification starting.
D1	Keyboard controller BAT test, CPU ID saved, and going to 4 GB flat mode.
D3	Do necessary chipset initialization, start memory refresh, and do memory sizing.
D4	Verify base memory.
D5	Init code to be copied to segment 0 and control to be transferred to segment 0.
D6	Control is in segment 0. To check recovery mode and verify main BIOS checksum. If either it is recovery mode or main BIOS checksum is bad, go to check point E0 for recovery else go to check point D7 for giving control to main BIOS.
D7	Find Main BIOS module in ROM image.
D8	Uncompress the main BIOS module.
D9	Copy main BIOS image to F000 shadow RAM and give control to main BIOS in F000 shadow RAM.

**Table 78. Boot Block Recovery Code Checkpoints**

Code	Description of POST Operation
E0	Onboard Floppy Controller (if any) is initialized. Compressed recovery code is uncompressed in F000:0000 in Shadow RAM and give control to recovery code in F000 Shadow RAM. Initialize interrupt vector tables, initialize system timer, initialize DMA controller and interrupt controller.
E8	Initialize extra (Intel Recovery) Module.
E9	Initialize floppy drive.
EA	Try to boot from floppy. If reading of boot sector is successful, give control to boot sector code.
EB	Booting from floppy failed, look for ATAPI (LS-120, Zip) devices.
EC	Try to boot from ATAPI. If reading of boot sector is successful, give control to boot sector code.
EF	Booting from floppy and ATAPI device failed. Give two beeps. Retry the booting procedure again (go to check point E9).

**Table 79. Runtime Code Uncompressed in F000 Shadow RAM**

<b>Code</b>	<b>Description of POST Operation</b>
03	NMI is Disabled. To check soft reset/power-on.
05	BIOS stack set. Going to disable cache if any.
06	POST code to be uncompressed.
07	CPU init and CPU data area init to be done.
08	CMOS checksum calculation to be done next.
0B	Any initialization before keyboard BAT to be done next.
0C	KB controller I/B free. To issue the BAT command to keyboard controller.
0E	Any initialization after KB controller BAT to be done next.
0F	Keyboard command byte to be written.
10	Going to issue Pin-23,24 blocking/unblocking command.
11	Going to check pressing of <INS>, <END> key during power-on.
12	To init CMOS if "Init CMOS in every boot" is set or <END> key is pressed. Going to disable DMA and Interrupt controllers.
13	Video display is disabled and port-B is initialized. Chipset init about to begin.
14	8254 timer test about to start.
19	About to start memory refresh test.
1A	Memory Refresh line is toggling. Going to check 15 $\mu$ s ON/OFF time.
23	To read 8042 input port and disable Megakey GreenPC feature. Make BIOS code segment writeable.
24	To do any setup before Int vector init.
25	Interrupt vector initialization to begin. To clear password if necessary.
27	Any initialization before setting video mode to be done.
28	Going for monochrome mode and color mode setting.
2A	Different buses init (system, static, output devices) to start if present. (See Section 5.3 for details of different buses.)
2B	To give control for any setup required before optional video ROM check.
2C	To look for optional video ROM and give control.
2D	To give control to do any processing after video ROM returns control.
2E	If EGA/VGA not found then do display memory R/W test.
2F	EGA/VGA not found. Display memory R/W test about to begin.
30	Display memory R/W test passed. About to look for the retrace checking.
31	Display memory R/W test or retrace checking failed. To do alternate Display memory R/W test.
32	Alternate Display memory R/W test passed. To look for the alternate display retrace checking.
34	Video display checking over. Display mode to be set next.
37	Display mode set. Going to display the power-on message.
38	Different buses init (input, IPL, general devices) to start if present. (See Section 5.3 for details of different buses.)
39	Display different buses initialization error messages. (See Section 5.3 for details of different buses.)
3A	New cursor position read and saved. To display the Hit <DEL> message.

continued

**Table 79. Runtime Code Uncompressed in F000 Shadow RAM (continued)**

Code	Description of POST Operation
40	To prepare the descriptor tables.
42	To enter in virtual mode for memory test.
43	To enable interrupts for diagnostics mode.
44	To initialize data to check memory wrap around at 0:0.
45	Data initialized. Going to check for memory wrap around at 0:0 and finding the total system memory size.
46	Memory wrap around test done. Memory size calculation over. About to go for writing patterns to test memory.
47	Pattern to be tested written in extended memory. Going to write patterns in base 640k memory.
48	Patterns written in base memory. Going to find out amount of memory below 1M memory.
49	Amount of memory below 1M found and verified. Going to find out amount of memory above 1M memory.
4B	Amount of memory above 1M found and verified. Check for soft reset and going to clear memory below 1M for soft reset. (If power on, go to check point # 4Eh).
4C	Memory below 1M cleared. (SOFT RESET) Going to clear memory above 1M.
4D	Memory above 1M cleared. (SOFT RESET) Going to save the memory size. (Go to check point # 52h).
4E	Memory test started. (NOT SOFT RESET) About to display the first 64k memory size.
4F	Memory size display started. This will be updated during memory test. Going for sequential and random memory test.
50	Memory testing/initialization below 1M complete. Going to adjust displayed memory size for relocation/ shadow.
51	Memory size display adjusted due to relocation/ shadow. Memory test above 1M to follow.
52	Memory testing/initialization above 1M complete. Going to save memory size information.
53	Memory size information is saved. CPU registers are saved. Going to enter in real mode.
54	Shutdown successful, CPU in real mode. Going to disable gate A20 line and disable parity/NMI.
57	A20 address line, parity/NMI disable successful. Going to adjust memory size depending on relocation/shadow.
58	Memory size adjusted for relocation/shadow. Going to clear Hit <DEL> message.
59	Hit <DEL> message cleared. <WAIT...> message displayed. About to start DMA and interrupt controller test.
60	DMA page register test passed. To do DMA#1 base register test.
62	DMA#1 base register test passed. To do DMA#2 base register test.
65	DMA#2 base register test passed. To program DMA unit 1 and 2.
66	DMA unit 1 and 2 programming over. To initialize 8259 interrupt controller.
7F	Extended NMI sources enabling is in progress.
80	Keyboard test started. Clearing output buffer, checking for stuck key, to issue keyboard reset command.
81	Keyboard reset error/stuck key found. To issue keyboard controller interface test command.
82	Keyboard controller interface test over. To write command byte and init circular buffer.
83	Command byte written, global data init done. To check for lock-key.

continued

**Table 79. Runtime Code Uncompressed in F000 Shadow RAM (continued)**

<b>Code</b>	<b>Description of POST Operation</b>
84	Lock-key checking over. To check for memory size mismatch with CMOS.
85	Memory size check done. To display soft error and check for password or bypass setup.
86	Password checked. About to do programming before setup.
87	Programming before setup complete. To uncompress SETUP code and execute CMOS setup.
88	Returned from CMOS setup program and screen is cleared. About to do programming after setup.
89	Programming after setup complete. Going to display power-on screen message.
8B	First screen message displayed. <WAIT...> message displayed. PS/2 Mouse check and extended BIOS data area allocation to be done.
8C	Setup options programming after CMOS setup about to start.
8D	Going for hard disk controller reset.
8F	Hard disk controller reset done. Floppy setup to be done next.
91	Floppy setup complete. Hard disk setup to be done next.
95	Init of different buses optional ROMs from C800 to start. (See Section 5.3 for details of different buses.)
96	Going to do any init before C800 optional ROM control.
97	Any init before C800 optional ROM control is over. Optional ROM check and control will be done next.
98	Optional ROM control is done. About to give control to do any required processing after optional ROM returns control and enable external cache.
99	Any initialization required after optional ROM test over. Going to setup timer data area and printer base address.
9A	Return after setting timer and printer base address. Going to set the RS-232 base address.
9B	Returned after RS-232 base address. Going to do any initialization before Coprocessor test.
9C	Required initialization before Coprocessor is over. Going to initialize the Coprocessor next.
9D	Coprocessor initialized. Going to do any initialization after Coprocessor test.
9E	Initialization after Coprocessor test is complete. Going to check extended keyboard, keyboard ID and num-lock.
A2	Going to display any soft errors.
A3	Soft error display complete. Going to set keyboard typematic rate.
A4	Keyboard typematic rate set. To program memory wait states.
A5	Going to enable parity/NMI.
A7	NMI and parity enabled. Going to do any initialization required before giving control to optional ROM at E000.
A8	Initialization before E000 ROM control over. E000 ROM to get control next.
A9	Returned from E000 ROM control. Going to do any initialization required after E000 optional ROM control.
AA	Initialization after E000 optional ROM control is over. Going to display the system configuration.
AB	Put INT13 module runtime image to shadow.
AC	Generate MP for multiprocessor support (if present).
AD	Put CGA INT10 module (if present) in Shadow.

continued

**Table 79. Runtime Code Uncompressed in F000 Shadow RAM (continued)**

Code	Description of POST Operation
AE	Uncompress SMBIOS module and init SMBIOS code and form the runtime SMBIOS image in shadow.
B1	Going to copy any code to specific area.
00	Copying of code to specific area done. Going to give control to INT-19 boot loader.

## 5.3 Bus Initialization Checkpoints

The system BIOS gives control to the different buses at several checkpoints to do various tasks. Table 80 describes the bus initialization checkpoints.

**Table 80. Bus Initialization Checkpoints**

Checkpoint	Description
2A	Different buses init (system, static, and output devices) to start if present.
38	Different buses init (input, IPL, and general devices) to start if present.
39	Display different buses initialization error messages.
95	Init of different buses optional ROMs from C800 to start.

While control is inside the different bus routines, additional checkpoints are output to port 80h as WORD to identify the routines under execution. In these WORD checkpoints, the low byte of the checkpoint is the system BIOS checkpoint from which the control is passed to the different bus routines. The high byte of the checkpoint is the indication of which routine is being executed in the different buses. Table 81 describes the upper nibble of the high byte and indicates the function that is being executed.

**Table 81. Upper Nibble High Byte Functions**

Value	Description
0	func#0, disable all devices on the bus concerned.
1	func#1, static devices init on the bus concerned.
2	func#2, output device init on the bus concerned.
3	func#3, input device init on the bus concerned.
4	func#4, IPL device init on the bus concerned.
5	func#5, general device init on the bus concerned.
6	func#6, error reporting for the bus concerned.
7	func#7, add-on ROM init for all buses.

Table 82 describes the lower nibble of the high byte and indicates the bus on which the routines are being executed.

**Table 82. Lower Nibble High Byte Functions**

Value	Description
0	Generic DIM (Device Initialization Manager)
1	On-board System devices
2	ISA devices
3	EISA devices
4	ISA PnP devices
5	PCI devices

## 5.4 Speaker

A 47  $\Omega$  inductive speaker is mounted on the D850GB board. The speaker provides audible error code (beep code) information during POST.

For information about	Refer to
The location of the onboard speaker	Figure 1, page 14

## 5.5 BIOS Beep Codes

Whenever a recoverable error occurs during POST, the BIOS displays an error message describing the problem (see Table 83). The BIOS also issues a beep code (one long tone followed by two short tones) during POST if the video configuration fails (a faulty video card or no card installed) or if an external ROM module does not properly checksum to zero.

An external ROM module (for example, a video BIOS) can also issue audible errors, usually consisting of one long tone followed by a series of short tones. For more information on the beep codes issued, check the documentation for that external device.

There are several POST routines that issue a POST terminal error and shut down the system if they fail. Before shutting down the system, the terminal-error handler issues a beep code signifying the test point error, writes the error to I/O port 80h, attempts to initialize the video and writes the error in the upper left corner of the screen (using both monochrome and color adapters).

If POST completes normally, the BIOS issues one short beep before passing control to the operating system.

**Table 83. Beep Codes**

<b>Beep</b>	<b>Description</b>
1	Refresh failure
2	Parity cannot be reset
3	First 64 KB memory failure
4	Timer not operational
5	Not used
6	8042 GateA20 cannot be toggled
7	Exception interrupt error
8	Display memory R/W error
9	Not used
10	CMOS Shutdown register test error
11	Invalid BIOS (e.g. POST module not found, etc.)

## 5.6 Diagnostic LEDs

The enhanced diagnostics feature consists of a hardware decoder and four LEDs located between the LAN connector and the serial port connector on the back panel. This feature requires no modifications to the chassis (other than I/O back panel shield) or cabling.



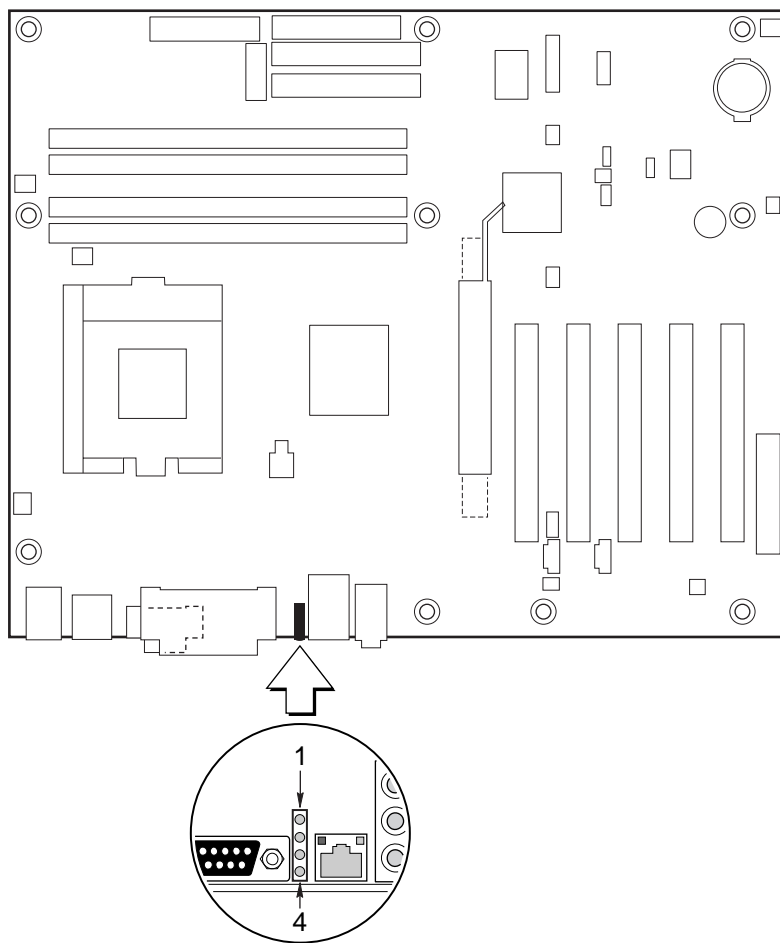













Figure 17 shows the location of the diagnostic LEDs. Table 84 lists the diagnostic codes displayed by the LEDs.



OM10451

Figure 17. Diagnostic LEDs

**Table 84. Diagnostic LED Codes**

Display		BIOS Operation	Display		BIOS Operation
	Amber Amber Amber Amber	Power on, starting BIOS		Amber Amber Amber Green	Undefined
	Green Amber Amber Amber	Recovery mode		Green Amber Amber Green	Undefined
	Amber Green Amber Amber	Processor, cache, etc.		Amber Green Amber Green	Undefined
	Green Green Amber Amber	Memory, auto-size, shadow, etc.		Green Green Amber Green	Undefined
	Amber Amber Green Amber	PCI bus initialization		Amber Amber Green Green	Undefined
	Green Amber Green Amber	Video		Green Amber Green Green	Undefined
	Amber Green Green Amber	IDE bus initialization		Amber Green Green Green	Undefined
	Green Green Green Amber	USB initialization		Green Green Green Green	Booting operating system

Note: Undefined states are reserved for future use.

⇒ **NOTE**

*After the computer has booted, the diagnostic LEDs remain green during normal operation.*

