

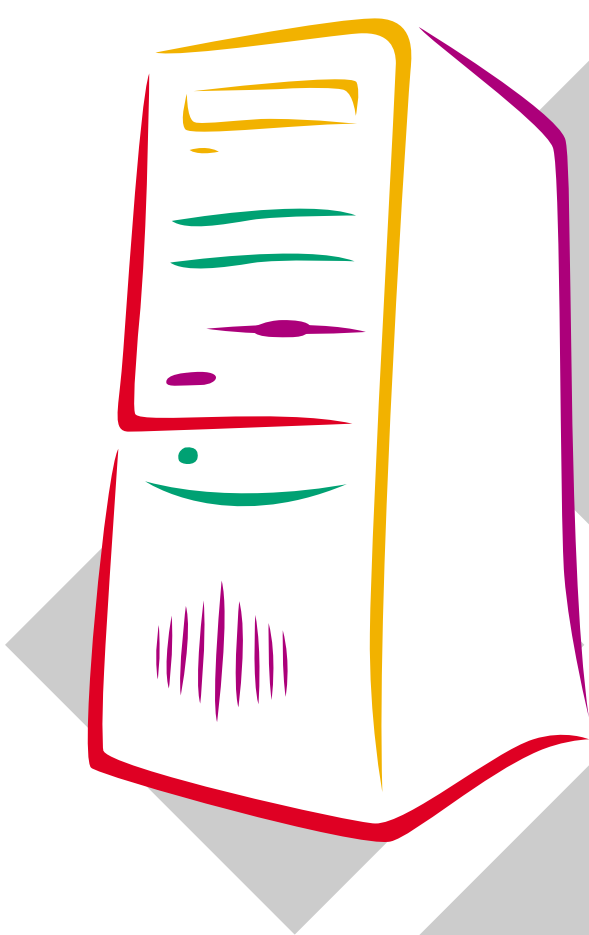

Aries/Centella

U S E R M A N U A L





System Manual

Copyright

Premio is a registered trademark of Premio Computer, Inc. All other brands and product names are trademarks or registered trademarks of their respective companies.

© 1997 by Premio Computer, Inc. All rights reserved.

Printed in Taiwan.

Centella, May 2000.

Disclaimers

Premio makes no representation or warranties, either expressed or implied, with respect to the contents of this publication and specifically disclaims the implied warranties of merchantability or fitness for a particular purpose. Premio shall not be liable for technical or editorial errors or omissions in this publication, or for incidental or consequential damages resulting from the furnishing, performance, or use of this publication. We reserve the right to revise this publication and to make changes from time to time in its contents without notification.

Contents

GETTING STARTED	1
Setting Up	2
Switches and Indicators	3
UPGRADING	5
Opening the System Unit	6
Installing an Expansion Card.....	7
Installing a Hard Drive	8
GETTING HELP	9
Troubleshooting	9
Monitor Does Not Work.....	9
Keyboard Does Not Work	10
Mouse Does Not Work.....	10
System Unit Problems	11
Hard Drive Problems.....	11
Technical Support	12
Premio on the Internet	12

APPENDIX.....	13
Warranty Policy	13
Service Under Warranty.....	14
Exclusions from Limited Warranty Programs.....	14
FCC Standards	15
Important Safety Instructions	16

Getting Started

Your Premio[®] system consists of three components:

- a mid-tower or desktop system unit
- a keyboard
- a mouse

Add your choice of monitor, and your system is ready to use.

Mid-tower system

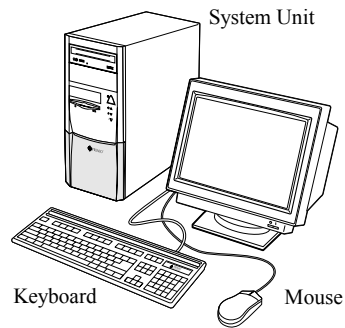

Desktop system

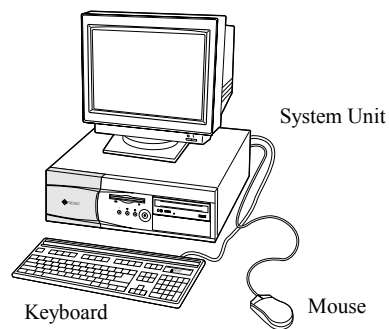

Setting Up

To set up your Premio system, simply connect your monitor, the mouse, the keyboard, and any additional components you want to use to the system unit.

Follow these easy steps:

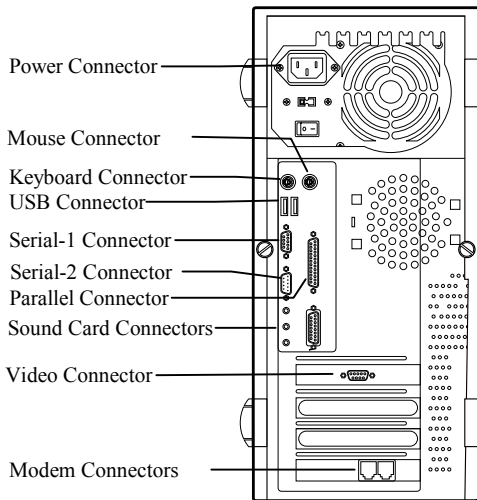

- 1** Attach your monitor's video cable to the video connector.
- 2** Attach the mouse cable to the mouse connector.
- 3** Attach the keyboard cable to the keyboard connector.
- 4** Attach the cables for any additional components, such as a printer, scanner, or modem, to the respective parallel, serial, or universal serial bus (USB) connector, as directed in the component's manual.
- 5** If your system is equipped for multimedia, attach your speakers and microphone to the sound card connectors.

- 6** Plug your monitor's power cord into a power outlet.
- 7** Attach the female end of the system power cord to the system unit's power connector, and then plug the other end of the cord into a power outlet.

Your Premio system is now ready to use. To start the system, turn on your monitor's power switch and then press the system power switch as shown on the next page.

Switches and Indicators

The system unit's front panel provides access to the CD-ROM and floppy drives, and to the system's switches and indicator lights.

The illustration below shows a mid-tower system. If you have a desktop system, turn to the illustration on the next page.

Mid-tower system

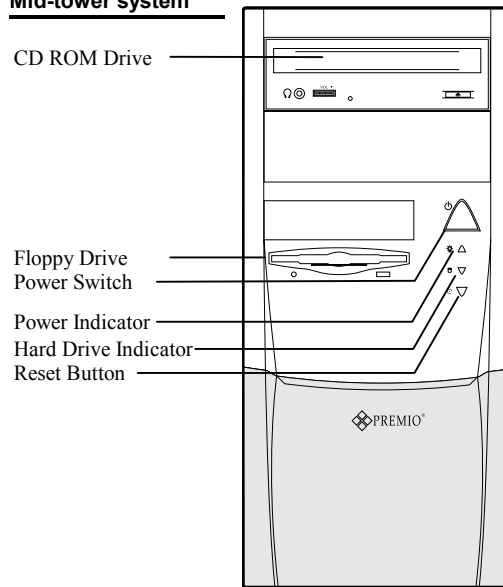

- The **CD-ROM drive** reads information on CDs.
- The **floppy drive** reads and writes information on diskettes.
- The **power switch** turns the system on and off.
- The **hard drive indicator** lights when the hard drive is in use.
- The **power indicator** lights when the system is on.
- The **reset button** restarts the system.

4 Premio System Manual

Desktop system

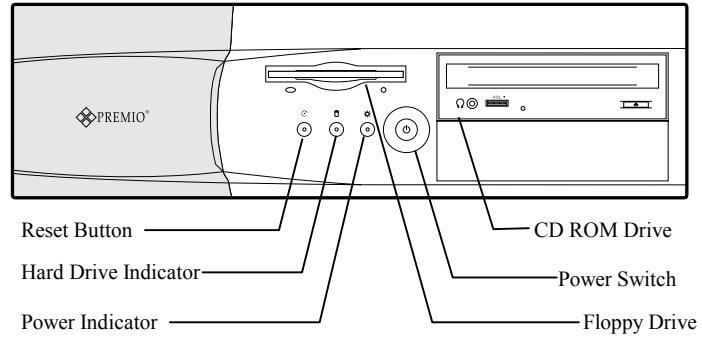

- The **reset button** restarts the system.
- The **hard drive indicator** lights when the hard drive is in use.
- The **power indicator** lights when the system is on.
- The **power switch** turns the system on and off.
- The **CD-ROM drive** reads information on CDs.
- The **floppy drive** reads and writes information on diskettes.

Upgrading

You can upgrade your Premio system with:

- Expansion cards
- More memory
- An additional hard drive

To install an upgrade, you must open the system unit. Before proceeding, read the important cautionary note below. Then follow the steps on the next page.

Caution! *Static discharge can cause permanent damage to internal electronic components of your computer. Always use the following precautions when working inside the system unit:*

- *Wear a grounding wrist strap (available at most electronics stores) when handling electronic components.*
- *Do not remove a component from its antistatic packaging until you are ready to install it.*
- *Keep one hand in contact with the metal system case.*

Opening the System Unit

Note: *Opening the system unit could affect your warranty. Check with the dealer where you purchased your system before opening the system unit.*

To open the system unit, follow these steps:

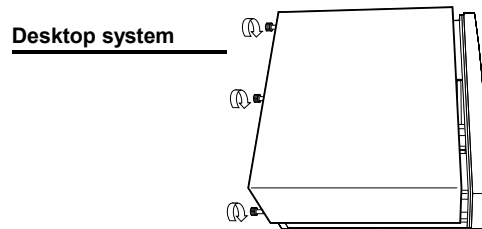
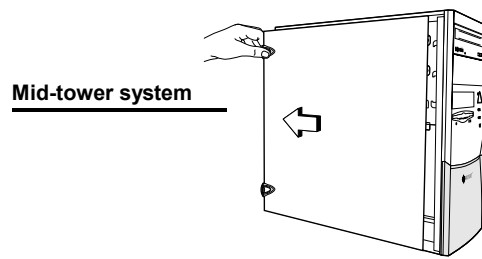

- 1** Turn off the system and unplug the power cord.
- 2** Remove the screws securing the side panel (mid-tower) or case (desktop) at the rear of the system unit.
- 3** Slide the side panel or case up and to the rear, and remove it.

Installing an Expansion Card

To install an expansion card, open the system unit as described on the previous page. Then follow these steps:

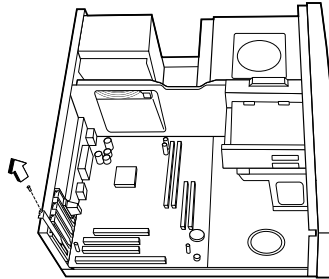

- 1** Remove the screw securing the slot bracket cover for the expansion slot you want to use. Save the screw to secure the expansion card.

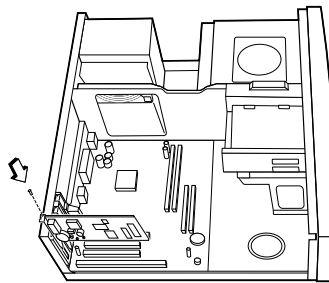

- 2** Insert the expansion card firmly into the slot, making sure it is seated completely.
- 3** Secure the card with the saved screw.

Installing a Hard Drive

To install a hard drive in your system, follow these steps:

- 1 Disconnect the hard drive cable and power connector.

Mid-tower system

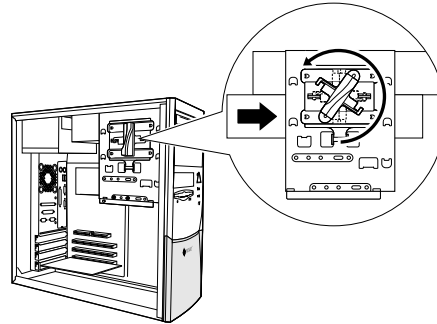

Desktop system

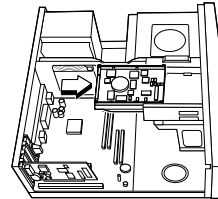

- 2 Remove the two screws securing the drive bay.
- 3 Slide the bay toward the rear of the system unit to remove it.
- 4 Insert the new drive into an open position in the bay and secure it with four screws.
- 5 Slide the bay back into the system unit and secure it with two screws.
- 6 Connect the cables.

Getting Help

Troubleshooting

Your Premio system is designed to provide years of trouble-free performance. If you have a problem with your system, first check the information in this section for a quick solution.

Monitor Does Not Work

If your monitor appears not to be working properly:

- Check that the monitor's power cable is securely attached to the monitor and to an outlet that is receiving power.
- Check that the monitor's video cable is securely attached to the monitor and to the system unit's video card connector.
- Check that the monitor's power switch is on.
- Adjust the monitor's brightness and contrast controls.
- If possible, substitute another monitor that is in good working order. If the substitute works, your monitor may need repair or replacement.

Keyboard Does Not Work

If the NumLock indicator in the upper right corner of the keyboard does not light when the system powers up, or the keyboard does not work:

- Check that the keyboard cable is securely attached to the system unit's keyboard connector.
- If possible, substitute another keyboard that is in good working order. If the substitute works, your keyboard may need replacement.

Mouse Does Not Work

If your mouse pointer does not move or moves erratically when you move the mouse:

- Check that the mouse cable is securely attached to the mouse connector on the system unit.
- Disassemble the mouse and clean the roller ball.

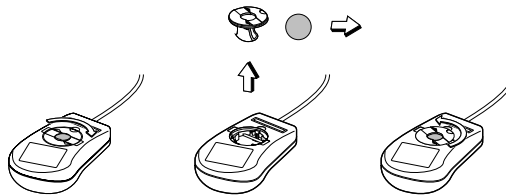

System Unit Problems

The fan inside the system unit should make a low, steady sound when operating properly. If the fan is totally silent:

- Check that the system power cord is securely attached to the back of the system unit and to a power outlet. Verify that the outlet has power.
- If possible, substitute another power cord that is in good working order. If the substitute works, replace your power cord.

If the fan makes excessive noise:

- Turn off the system, open the system unit case, and inspect the fan for any obstructions.
- Turn on the system and listen closely to the fan. If the noise comes from inside the fan housing, your power supply may need replacement.

Hard Drive Problems

Your hard drive should make a slight whirring sound when operating properly.

If the drive is totally silent:

- Turn off the system, open the system unit case, and check that the power cable between the power supply and the hard drive is securely attached at both ends. If it is, your hard drive may be defective.

If the hard drive makes excessive noise:

- Turn off the system, open the system unit case, and remove the hard drive power cable connector from the hard drive. Then turn the system back on. If the noise disappears, your hard drive may be defective.
- If you have more than one hard drive, repeat the same procedure for each drive.

Technical Support

You can contact Premio technical support at the following address:

Premio Computer, Inc.

918 Radecki Court

City of Industry, CA 91748

Telephone: 626.839.3100

Fax: 626.839.3191

Email: support@premiopc.com

Web page: <http://support.premiopc.com>

Premio on the Internet

Premio maintains a web page on the Internet with the latest information on Premio products, updated drivers, answers to common problems, a troubleshooting guide, and more. Visit our web page at:

<http://www.premiopc.com>

Appendix

Warranty Policy

Premio Computer, Inc. warrants its line of Premio[®] computer systems to be free from defects in material and workmanship for a specific warranted period as stated below, from the date of original purchase from Premio Computer, Inc. or a Premio Computer, Inc. authorized reseller. This warranty is contingent upon proper use of the product in question and does not cover products which have been modified or which have been subjected to unusual physical or electrical stress. Warranty for third party hardware and software, if any, is subject to the third party's warranty policy. Please refer to the following for length of warranty for Premio's product line.

Premio Product	Warranty
Complete Premio System with monitor	3 years parts and labor
Premio Barebone (with or without CPU)	2 years parts and labor
Premio Monitor	2 year parts and labor
Premio OEM Component (motherboard, speaker, case, keyboard, mouse, floppy drive, CD-ROM, etc.)	2 years parts and labor

Service Under Warranty

If this product fails to be in good working order during the warranty period (or specific period of time as noted above), Premio Computer, Inc. will, at its option, repair or replace the product. Repair parts and/or replacement products may be either new or reconditioned at Premio Computer Inc.'s discretion. The limited warranty does not include service or repair for damage from improper installation, abuse or modifications to the product not approved in writing by Premio Computer, Inc. Any service repair outside the scope of this limited warranty will be at Premio Computer, Inc.'s or its Authorized Service Provider's rates and terms in effect. This warranty is valid only within the United States, Puerto Rico, Canada, Mexico and South America.

Exclusions from Limited Warranty Programs

All other expressed and implied warranties for this product are hereby disclaimed. If this product is not in good working order as warranted above, Premio Computer's sole and exclusive remedy shall be repair or replacement as stated above. In no event will Premio Computer, Inc. be liable to the customer or any third party for any damages in excess of the purchase price of the product. This limitation applies to damages of any kind including any direct or indirect damages, lost profits, lost savings or other special, incidental or consequential damages. This holds true for situations even if Premio Computer, Inc. or an authorized Premio representative or dealer has been advised of the possibility of such damages or of any claim by another party. Some states do not allow the exclusion or limitation of incidental or consequential damages for some products, so the above limitation or exclusion may not apply to you. Premio Computer, Inc. authorized resellers and service providers/partners may be changed, added or deleted, without notice or liability. Premio Computer, Inc. disclaims any authorized resellers and service provider/partner to the program. This warranty gives you specific legal rights and you may also have other rights, which may vary from state to state.

FCC Standards

This equipment has been tested and found to comply with the limits for a Class B digital device, pursuant to Part 15 of the FCC Rules. These limits are designed to provide reasonable protection against harmful interference in a residential installation. This equipment generates, uses and can radiate radio frequency energy and, if not installed and used in accordance with the instructions, may cause harmful interference to radio communications. However, there is no guarantee that interference will not occur in a particular installation. If this equipment does cause harmful interference to radio or television reception, which can be determined by turning the equipment off and on, the user is encouraged to try to correct the interference by one or more of the following measures:

- Reorient or relocate the receiving antenna.
- Increase the separation between the equipment and receiver.
- Connect the equipment into an outlet on a circuit different from that to which the receiver is connected.
- Consult the dealer or an experienced radio/TV technician for help.

Important Safety Instructions

These instructions are provided by Underwriters Laboratories, Inc.

1. Read all of these instructions and save them for later reference.
2. Follow all warnings and instructions marked on the product.
3. Unplug this product from the wall outlet before cleaning. Do not use liquid or aerosol cleaners. Use a damp cloth for cleaning.
4. Do not use this product near water.
5. Do not place this product on an unstable cart, stand or table. The product may fall, causing serious damage to the product.
6. Slots and openings on the cabinet and the back or bottom are provided for ventilation. To ensure reliable operation of the product and to protect it from overheating, do not block or cover these openings. The openings should never be blocked by placing the product on a bed, sofa, rug or other similar surface. This product should never be placed near or over a radiator or heat register. This product should not be placed in a built-in installation unless proper ventilation is provided.
7. This product should be operated from the type of power source indicated on the marking label. If you are not sure of the type of power available, consult your dealer or local power company.
8. This product is equipped with a 3-wire grounding-type plug, a plug having a third (grounding) pin. This plug will only fit into a grounding-type power outlet. This is a safety feature. If you are unable to insert the plug into the outlet, contact your electrician to replace your obsolete outlet. Do not defeat the safety purpose of the grounding-type plug.
9. Do not allow anything to rest on the power cord. Do not locate this product where the cord will be walked on.
10. If an extension cord is used with this product, make sure that the total of the ampere ratings on the products plugged into the extension cord do not exceed the extension cord ampere rating. Also, make sure that the total of all products plugged into the wall outlet does not exceed 15 amperes.
11. Never push objects of any kind into this product through cabinet slots as they may touch dangerous voltage points or short out parts

that could result in a risk of fire or electric shock. Never spill liquid of any kind on the product.

12. Except as explained elsewhere in this manual, don't attempt to service this product yourself. Opening and removing those covers that are marked "Do Not Remove" may expose you to dangerous voltage points or other risks. Refer all servicing on those compartments to service personnel.
13. Unplug this product from the wall outlet and refer servicing to qualified service personnel under the following conditions:
 - A. When the power cord or plug is damaged or frayed.
 - B. If liquid has been spilled into the product.
 - C. If the product has been exposed to rain or water.
 - D. If the product does not operate normally when the operating instructions are followed. Adjust only those controls that are covered by the operating instructions since improper adjustment of other controls may result in damage and will often require extensive work by a qualified technician to restore the product to normal operation.
 - E. If the product has been dropped or the cabinet has been damaged.
 - F. If the product exhibits a distinct change in performance, indicating a need for service.

Chapter 1

INTRODUCTION

The MS-6334 Micro-ATX S5 mainboard is a high-performance computer mainboard based on Intel® 815 chipset. The MS-6334 is optimized to support the Intel® Pentium® III (FC-PGA) processor for high-end business/personal desktop markets.

The Intel® 815 chipset integrates a Display Cache SDRAM controller that supports a 32-bit 133MHz SDRAM array for enhanced integrated 3D graphics performance. It is a highly-flexible chipset which is designed to extend the basic graphics/multimedia PC platform up to the mainstream performance desktop platform.

The Intel® 815 chipset implements the host address, control, and data bus interfaces within a single device. It takes advantage of the pipelined addressing capability of the processor to improve the overall system performance. In addition, the chipset also integrates a system memory controller that supports a 64-bit 100/133 MHz SDRAM array.

The Intel® 82801AA (ICH) chipset is a highly integrated multifunctional I/O Controller Hub that provides the interface to the PCI Bus and integrates many of the functions needed in today's PC platforms. It communicates with the host controller over a dedicated hub interface and provides added flexibility in designing cost-effective system solutions.

1.1 Mainboard Features

CPU

- Support Socket 370 for Intel® Celeron™/Pentium III(FC-PGA) processor
- Support 500MHz, 550MHz, 600MHz, 633MHz, 667MHz and up to 9XX

Chipset

- Intel® 815 chipset. (544 BGA)
 - AGP 4x/2x/1x universal slot
 - Support 66/100/133MHz FSB
- Intel® ICH chipset.
 - AC'97 Controller Integrated
 - 2 full IDE channels, up to ATA66
 - Low pin count interface for Winbond SIO

Main Memory

- Supports up to 3 double sided DIMMs at 100 MHz system memory bus.
- Supports up to 2 double sided or 3 single sided DIMMs at 133MHz system memory bus.
- Support 32 to 512MB using 16/64/128/256Mbit technology.

Slots

- One CNR(Communication Network Riser).
- One AGP(Accelerated Graphics Port) 4x/2x/1x slot.
- Three PCI 2.2 32-bit Master PCI Bus slots.
- Support 3.3v/5v PCI bus Interface.

On-Board IDE

- An IDE controller on the ICH chipset provides IDE HDD/CD-ROM with PIO, Bus Master and Ultra DMA66 operation modes.
- Can connect up to four IDE devices.

On-Board Peripherals

- On-Board Peripherals include:
 - 1 floppy port supports 2 FDD with 360K, 720K, 1.2M, 1.44M and 2.88Mbytes.
 - 2 serial port (COMA + COMB--header)
 - 1 parallel port supports SPP/EPP/ECP mode
 - 4 USB ports (Rear * 2/Front * 2)
 - 1 VGA port
 - 1 Line-In/Line-Out/Mic-In/Game Port

Video

- GMCH chip integrated
- 2D/3D Graphics
- Intel® D.V.M Technology
- Flexible AGP In-Line Memory Module(AIMM) (optional)
- One AGP slot for external AGP card

Audio

- ICH chip integrated
- Sigmatel 9721
 - AC97 2.1 Compliant.
 - Support 2 Channel Audio
- Creative® CT5880. (Optional)
 - PCI 2.2 compliant
 - PC98/99 specification compliant
 - 3D audio effects.
 - 32-voice XG wavetable synthesizer
 - Direct Sound Hardware Accelerator
 - Direct Music Hardware Accelerator
 - Full-Duplex stereo
 - Support SPDIF connector

BIOS

- The mainboard BIOS provides “Plug & Play” BIOS which detects the peripheral devices and expansion cards of the board automatically.
- The mainboard provides a Desktop Management Interface(DMI) function which records your mainboard specifications.

Dimension

- Micro-ATX Form Factor

Mounting

- 6 mounting holes.

1.2 Mainboard Layout

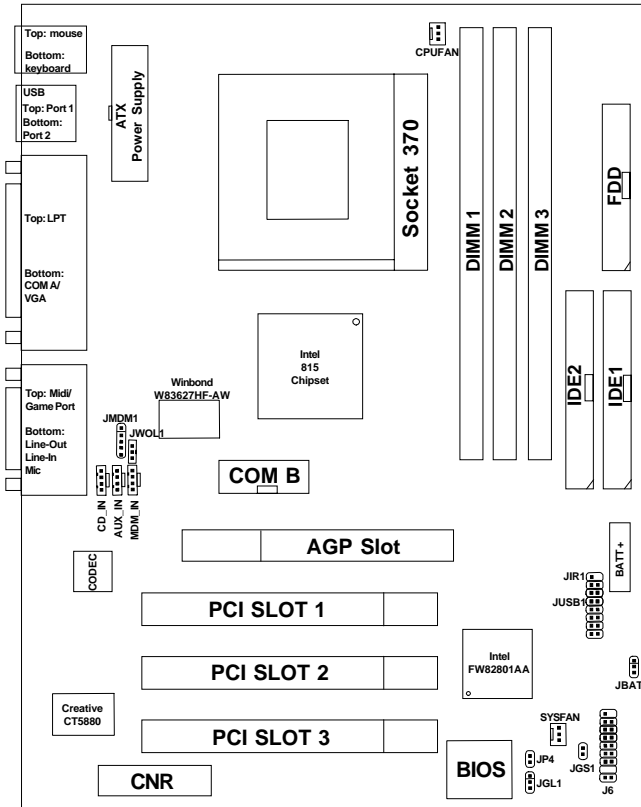

MS-6334 Micro-ATX S5 Mainboard

Chapter 2

HARDWARE INSTALLATION

2.1 Central Processing Unit: CPU

The mainboard operates with **Intel® Celeron™/Pentium® III (FC-PGA) processor**. The mainboard uses a CPU socket called Socket 370 for easy CPU installation. The CPU should always have a Heat Sink and a cooling fan attached to prevent overheating.

2.1-1 CPU Installation Procedures

1. Pull the lever sideways away from the socket. Then, raise the lever up to a 90-degree angle.
2. Locate Pin 1 in the socket and look for the white dot or cut edge in the CPU. Match Pin 1 with the white dot/cut edge. Then, insert the CPU. It should insert easily.
3. Press the lever down to complete the installation.

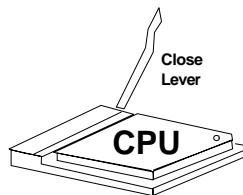
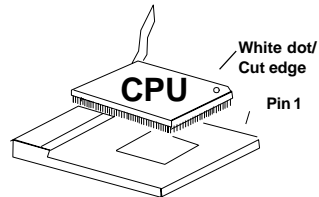
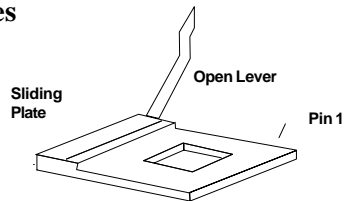

2.1-2 CPU Core Speed Derivation Procedure

The mainboard CPU Bus Frequency can be set through BIOS setup.

$$\begin{array}{ll} \textbf{If} & \text{CPU Clock} = 100\text{MHz} \\ & \text{Core/Bus ratio} = 7 \\ \textbf{then} & \text{CPU core speed} = \text{Host Clock} \times \text{Core/Bus ratio} \\ & = 700\text{MHz} \end{array}$$

2.1-3 Fan Power Connectors: CPUFAN & SYSFAN

These connector support system cooling fan with + 12V. It supports three pin head connector. When connecting the wire to the connector, always take note that the red wire is the positive and should be connected to the +12V, the black wire is Ground and should be connected to GND. If your mainboard has System Hardware Monitor chipset on-board, you must use a specially designed fan with speed sensor to take advantage of this function.

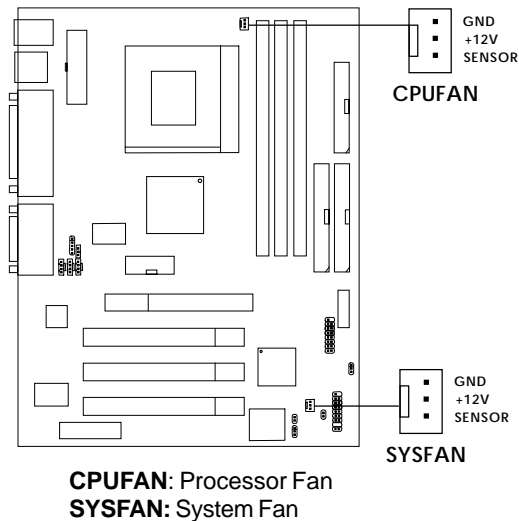

For fans with fan speed sensor, every rotation of the fan will send out 2 pulses. System Hardware Monitor will count and report the fan rotation speed.

Note:

1. Always consult vendor for proper CPU cooling fan.
2. CPU FAN supports the FAN control. You can install PC Alert utility. This will automatically control the CPU FAN Speed according to the actual CPU temperature.

2.2 Clear CMOS Jumper: JBAT1

A battery must be used to retain the mainboard configuration in CMOS RAM. Short 1-2 pins of JBAT1 to store the CMOS data.

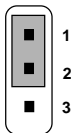
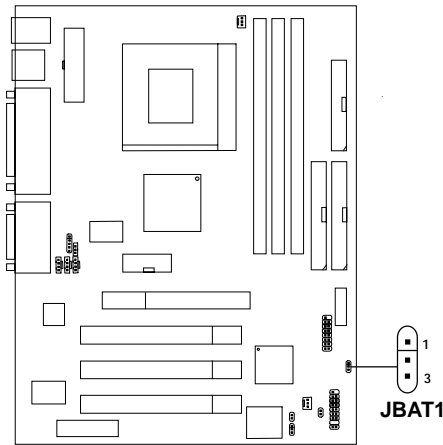

Keep Data

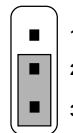

Clear Data

Note: You can clear CMOS by shorting 2-3 pin, while the system is off. Then, return to 1-2 pin position. Avoid clearing the CMOS while the system is on, it will damage the mainboard. Always unplug the power cord from the wall socket.

2.3 Memory Installation

2.3-1 Memory Bank Configuration

The mainboard supports a maximum memory size 512MB: It provides three 168-pin **unbuffered** DIMMs (Double In-Line Memory Module) sockets. It supports 8 MB to 128 Mbytes DIMM memory module.

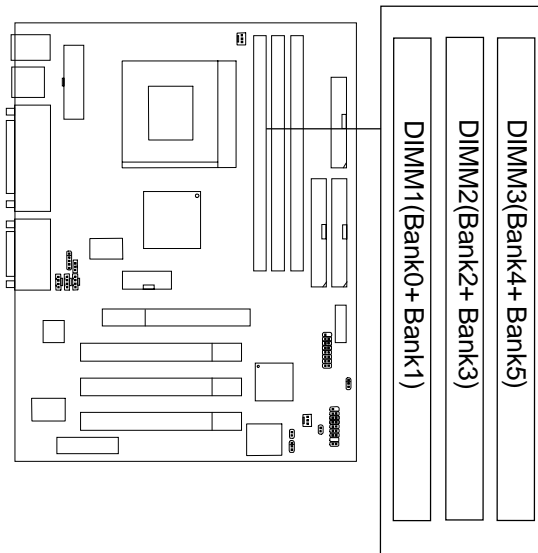

2.3-2 Memory Installation Procedures

A. How to install a DIMM Module

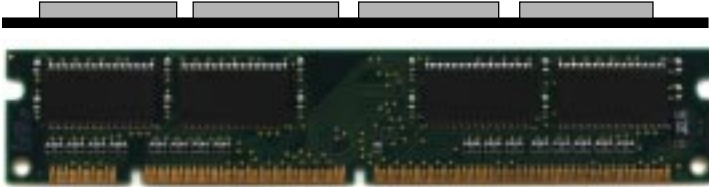

Single Sided DIMM

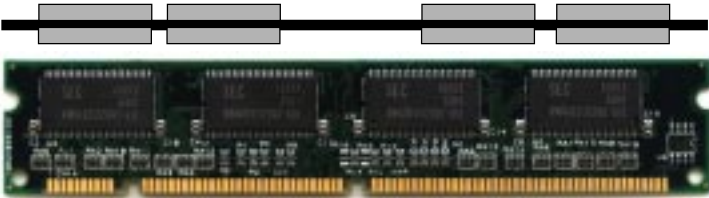

Double Sided DIMM

1. The DIMM slot has 2 Notch Keys “VOLT and DRAM”, so the DIMM memory module can only fit in one direction.
2. Insert the DIMM memory module vertically into the DIMM slot. Then push it in.

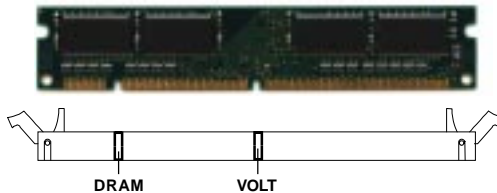

3. The plastic clip at the side of the DIMM slot will automatically close.

2.3-3 Memory Population Rules

1. Supports only SDRAM DIMM.
2. To operate properly, at least one 168-pin DIMM module must be installed.
3. This mainboard supports Table Free memory, so memory can be installed on DIMM1, DIMM2, DIMM3 in any order.
4. Supports 3.3 volt DIMM.
5. The DRAM addressing and the size supported by the mainboard is shown at the next page.

Table 2.3-1 SDRAM Memory Addressing

DRAM Tech.	DRAM Density & Width	DRAM Addressing	Address Size		MB/DIMM	
			Row	Column	Single no. Side(S) pcs.	Double no. Side(D) pcs.
16M	1Mx16	ASYM	11	8	8MBx4	16MBx8
	2Mx8	ASYM	11	9	16MBx8	32MBx16
	4Mx4	ASYM	11	10	32MB	64MB
64M	2Mx32	ASYM	11	9	32MBx2	64MBx4
	2Mx32	ASYM	12	8	16MBx2	32MBx4
	4Mx16	ASYM	11	10	32MB	64MB
	4Mx16	ASYM	13	8	32MB	64MB
	8Mx8	ASYM	13	9	64MB	128MB
	16Mx4	ASYM	13	10	128MB	256MB
	2Mx32	ASYM	12	8	16MB	32MB
64M	4Mx16	ASYM	13	8	32MB	64MB
	8Mx8	ASYM	13	9	64MB	128MB
	16Mx4	ASYM	13	10	128MB	256MB
256M	32Mx8	ASYM	14	9	256MB	512MB

2.4 Case Connector: J6

The Keylock, Power Switch, Reset Switch, Power LED, Speaker, and HDD LED are all connected to the JFP1 connector block.

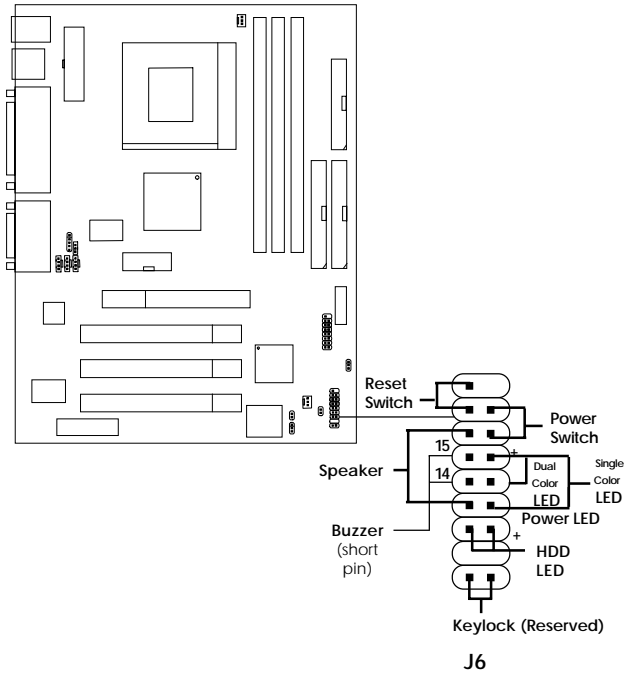

2.4-1 Power Switch

Connect to a 2-pin push button switch.

2.4-2 Reset Switch

Reset switch is used to reboot the system rather than turning the power ON/OFF. Avoid rebooting while the HDD LED is lit. You can connect the Reset switch from the system case to this pin.

2.4-3 Power LED

The Power LED is lit while the system power is on. Connect the Power LED from the system case to this pin. There are two types of LED that you can use: 3-pin single color LED or 2-pin dual color LED(ACPI request).

- a. 3 pin single color LED connect to pin 4, 5, & 6. This LED will lit when the system is on.
- b. 2 pin dual color LED connect to pin 5 & 6.
 - GREEN**Color: Indicate the system is in full on mode.
 - ORANGE**Color: Indicate the system is in suspend mode.

2.4-4 Speaker

Speaker from the system case is connected to this pin.

If on-board Buzzer is available:

Short pin 14-15: On-board Buzzer Enabled.

Open pin 14-15: On-board Buzzer Disabled.

2.4-5 HDD LED

HDD LED shows the activity of a hard disk drive. Avoid turning the power off while the HDD led is lit. You can connect the HDD LED from the system case to this pin.

2.4-6 Keylock

Keylock allows you to disable the keyboard for security purposes. You can connect the keylock to this pin.

2.5 Floppy Disk Connector: FDD

The mainboard also provides a standard floppy disk connector FDD that supports 360K, 720K, 1.2M, 1.44M and 2.88M floppy disk types. This connector supports the provided floppy drive ribbon cables.

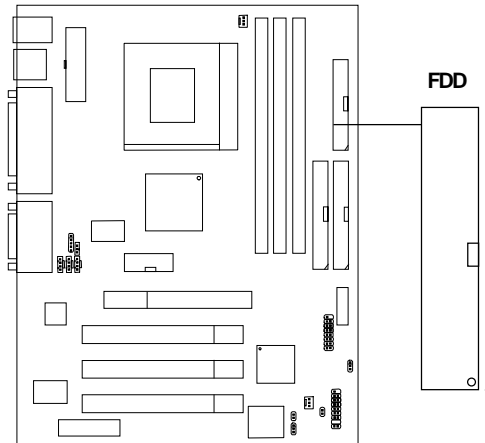

2.6 Hard Disk Connectors: IDE1 & IDE2

The mainboard has a 32-bit Enhanced PCI IDE and Ultra DMA/66 Controller that provides PIO mode 0~4, Bus Master, and Ultra DMA/33/66 function. It has two HDD connectors IDE1 (primary) and IDE2 (secondary). You can connect up to four hard disk drives, CD-ROM, 120MB Floppy and other devices to IDE1 and IDE2. These connectors support the provided IDE hard disk cable.

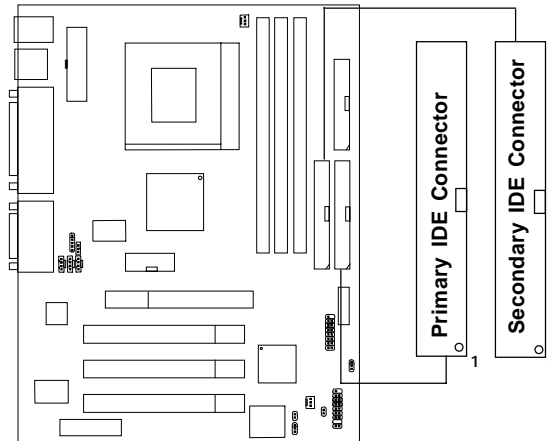

IDE1(Primary IDE Connector)

The first hard drive should always be connected to IDE1. IDE1 can connect a Master and a Slave drive. You must configure second hard drive to Slave mode by setting the jumper accordingly.

IDE2(Secondary IDE Connector)

IDE2 can also connect a Master and a Slave drive.

2.7 Power Supply

2.7-1 ATX 20-pin Power Connector: JWR1

This connector supports the power button on-board. Using the ATX power supply, functions such as Modem Ring Wake-Up and Soft Power Off are supported by this mainboard. This power connector supports instant power on function which means that system will boot up instantly when the power connector is inserted on the board.

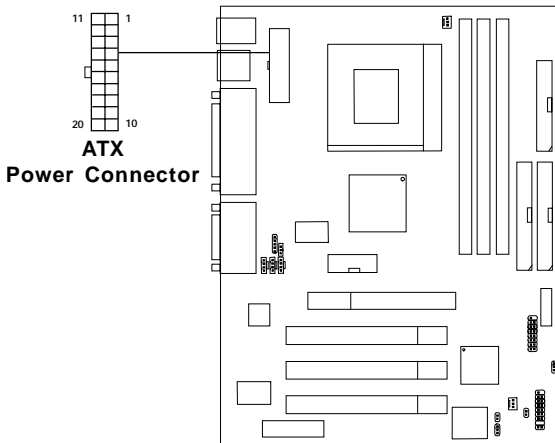

PIN DEFINITION

PIN	SIGNAL	PIN	SIGNAL
1	3.3V	11	3.3V
2	3.3V	12	-12V
3	GND	13	GND
4	5V	14	PS_ON
5	GND	15	GND
6	5V	16	GND
7	GND	17	GND
8	PW_OK	18	-5V
9	5V_SB	19	5V
10	12V	20	5V

Warning: Since the mainboard has the instant power on function, make sure that all components are installed properly before inserting the power connector to ensure that no damage will be done.

2.8 IrDA Infrared Module Connector: JIR1

The mainboard provides one infrared (JIR1) connector for IR modules. This connector is for optional wireless transmitting and receiving infrared module. You must configure the setting through the BIOS setup to use the IR function.

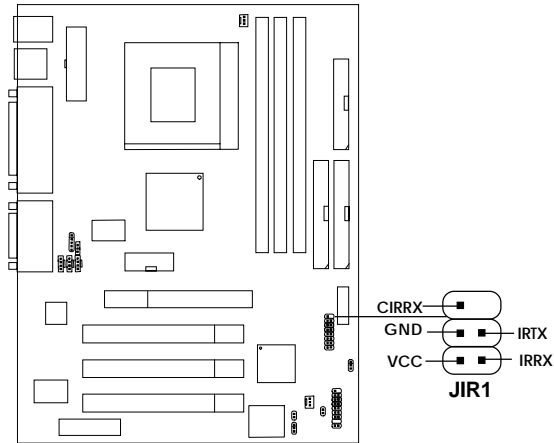

2.9 Serial Port Connectors: COM A

The mainboard has a 9-pin male DIN connector for serial port COM A. This port is a 16550A high speed communication port that send/receive 16 bytes FIFOs. You can attach a mouse or a modem cable directly into this connector.

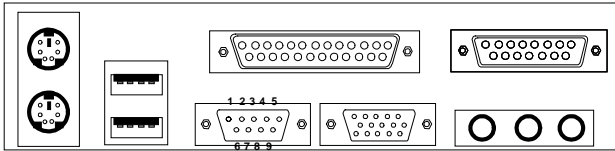

COM A

Serial Port (9-pin Male)

PIN DEFINITION

PIN	SIGNAL
1	DCD (Data Carry Detect)
2	SIN (Serial In or Receive Data)
3	SOUT (Serial Out or Transmit Data)
4	DTR (Data Terminal Ready)
5	GND
6	DSR (Data Set Ready)
7	RTS (Request To Send)
8	CTS (Clear To Send)
9	RI (Ring Indicate)

2.10 Parallel Port Connector: LPT1

The mainboard provides a 25 pin female centronic connector for LPT. A parallel port is a standard printer port that also supports Enhanced Parallel Port(EPP) and Extended capabilities Parallel Port(ECP). See connector and pin definition below:

Parallel Port (25-pin Female)

LPT 1

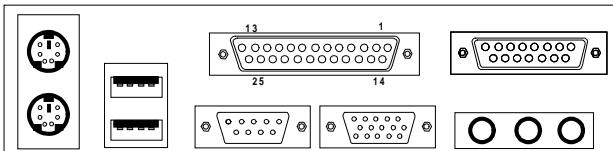

PIN DEFINITION

PIN	SIGNAL	PIN	SIGNAL
1	STROBE	14	AUTO FEED#
2	DATA0	15	ERR#
3	DATA1	16	INIT#
4	DATA2	17	SLIN#
5	DATA3	18	GND
6	DATA4	19	GND
7	DATA5	20	GND
8	DATA6	21	GND
9	DATA7	22	GND
10	ACK#	23	GND
11	BUSY	24	GND
12	PE	25	GND
13	SELECT		

2.11 Mouse Connector: JKBSM1

The mainboard provides a standard PS/2[®] mouse mini DIN connector for attaching a PS/2[®] mouse. You can plug a PS/2[®] mouse directly into this connector. The connector location and pin definition are shown below:

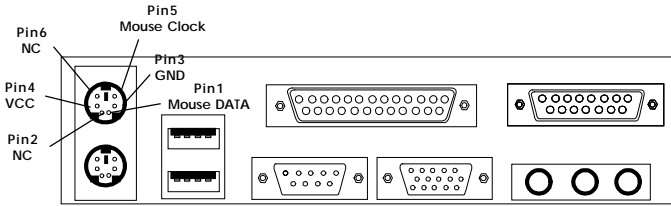

PS/2 Mouse (6-pin Female)

2.12 Keyboard Connector: JKBSM1

The mainboard provides a standard PS/2[®] keyboard mini DIN connector for attaching a keyboard. You can plug a keyboard cable directly to this connector.

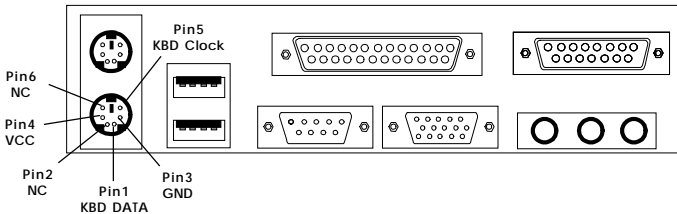

PS/2 Keyboard (6-pin Female)

2.13 Joystick/Midi Connectors

You can connect joystick or game pad to this connector.

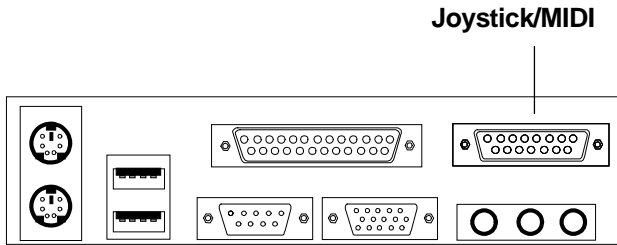

2.14 Audio Port Connectors

Line Out is a connector for Speakers or Headphones. **Line In** is used for external CD player, Tape player, or other audio devices. **Mic** is a connector for the microphones.

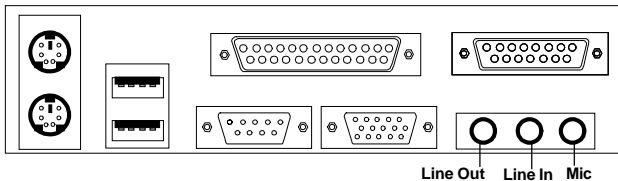

1/8" Stereo Audio Connectors

2.15 USB Connectors

The mainboard provides a **UHCI(Universal Host Controller Interface) Universal Serial Bus root** for attaching USB devices like: keyboard, mouse and other USB devices. You can plug the USB device directly to this connector.

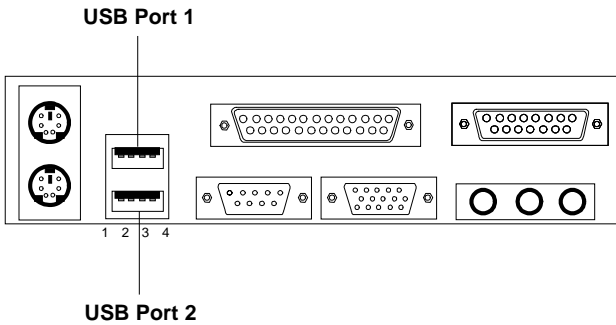

PIN	SIGNAL
1	VCC
2	-Data
3	+Data
4	GND

2.16 VGA DB 15 Pin Connector

The mainboard provides a DB 15-pin connector to connect to a VGA monitor.

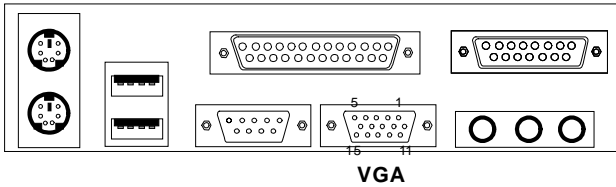

Analog Video Display Connector(DB15-S)	
Pin	Signal Description
1	Red
2	Green
3	Blue
4	Not used
5	Ground
6	Ground
7	Ground
8	Ground
9	Not used
10	Ground
11	Not used
12	SDA
13	Horizontal Sync
14	Vertical Sync
15	SCL

2.17 Power Saving Switch Connector: JGS1

Attach a power saving switch to **JGS1**. When the switch is pressed, the system immediately goes into suspend mode. Press any key and the system wakes up.

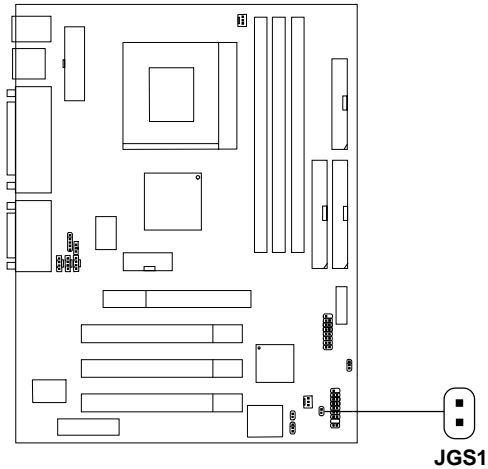

2.18 Power Saving LED Connector: JGL1

JGL1 can be connected with an LED. There are two types of LED that you can use: 3-pin LED or 2-pin LED(ACPI request). When the 2-pin LED is connected to JGL1, the light will turn green, when system is On. During sleep mode, the 2-pin LED will change color from Green to Orange. For 3-pin LED, when LED is connected to JGL1, this will light when the system is On and blinks when it is in suspend/sleep mode. See page 3-20 (Power status LED) for further instruction.

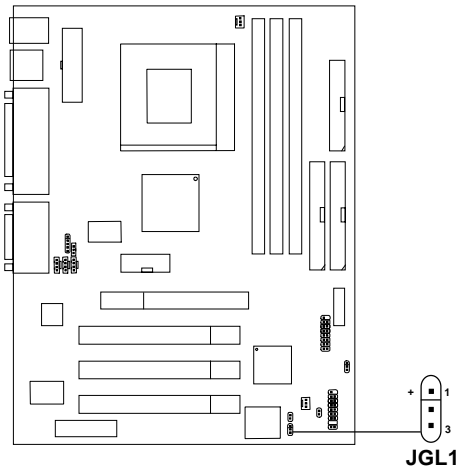

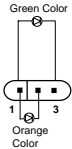
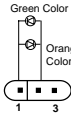
3-pin LED	2-pin LED
	
1-2 Single Color 1-3 Blink	1-2 Dual Color

2.19 Wake-Up on LAN Connector: JWOL1

The JWOL1 connector is for use with LAN add-on cards that supports Wake Up on LAN function. To use this function, you need to set the “Wake-Up on LAN” to enable at the BIOS Power Management Setup.

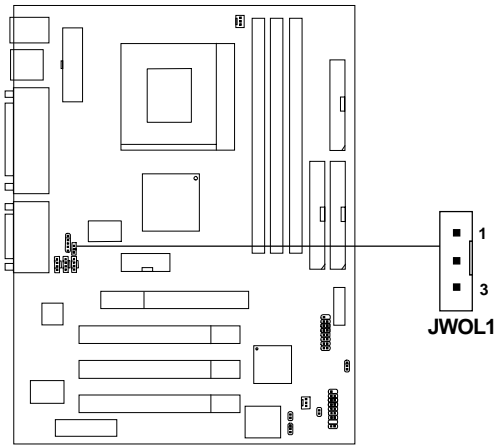

PIN	SIGNAL
1	5VSB
2	GND
3	MP_WAKEUP

Note: LAN wake-up signal is active “high”.

Note: To be able to use this function, you need a power supply that provide enough power for this feature. (Power supply with 750mA 5V Stand-by)

2.20 Modem Wake Up Connector: JMDM1

The JMDM1 connector is for used with Modem add-on card that supports the Modem Wake Up function. To use this function, you need to set the “Power On by Ring” to enable at the BIOS Power Management Setup.

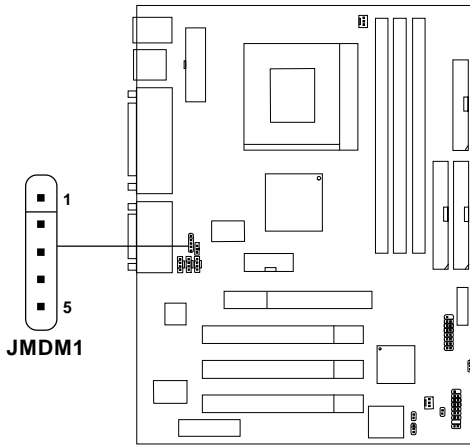

PIN	SIGNAL
1	NC
2	GND
3	MDM_WAKEUP
4	NC
5	5VSB

Note: Modem wake-up signal is active “low”.

Note: To be able to use this function, you need a power supply that provide enough power for this feature. (Power supply with 750mA 5V Stand-by)

2.21 Modem-In: MDM_IN

The connector is for Modem with internal voice connector.

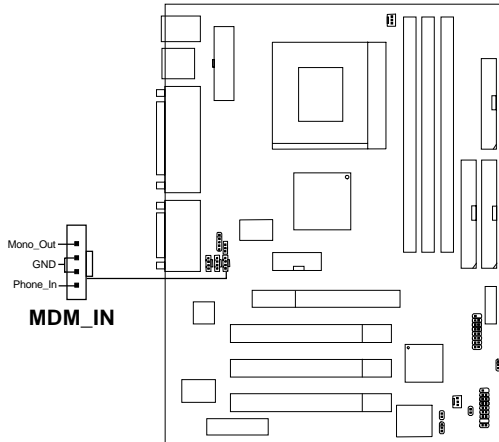

Mono_Out is connected to the Modem Speaker Out connector.

Phone_In is connected to the Modem Microphone In connector.

2.22 AUX Line In Connector: AUX_IN

This connector is used for DVD add-on card with Line In connector.

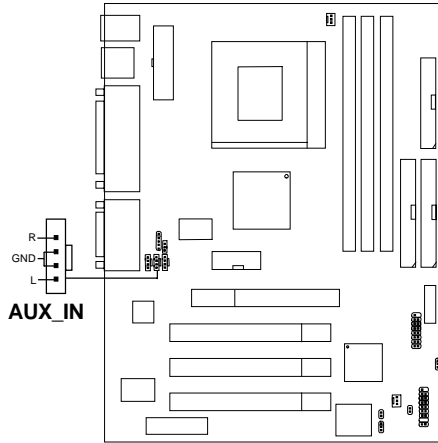

2.23 CD-In Connector: CD_IN

This connector is for CD-ROM audio connector.

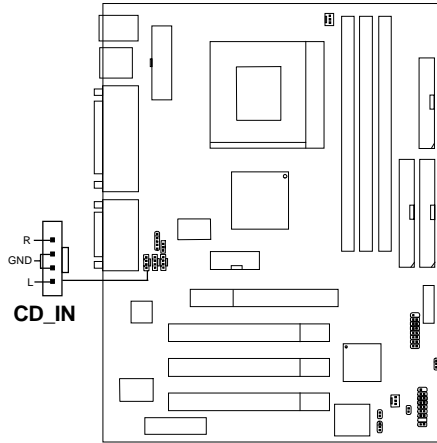

2.24 BIOS Flash Jumper: JBIOS

This jumper is used to locked/unlocked BIOS Flash. This Jumper should be unlocked when flashing/programming the BIOS.

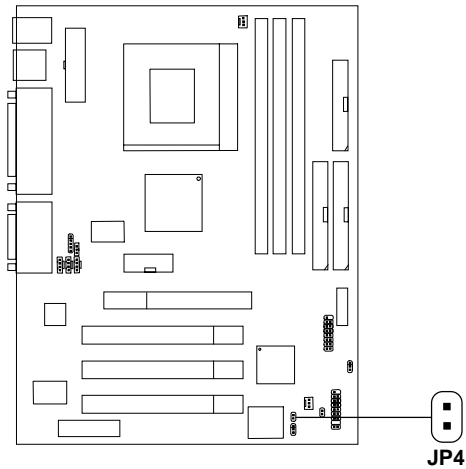

**BIOS Flash
Locked**



**BIOS Flash
Unlocked**

2.25 CNR (Communication Network Riser)

The Communication Network Riser specification is an open industry-standard specification that defines a hardware scalable Original Equipment Manufacturer (OEM) mainboard riser board and interface, **which supports both audio and modem only.**

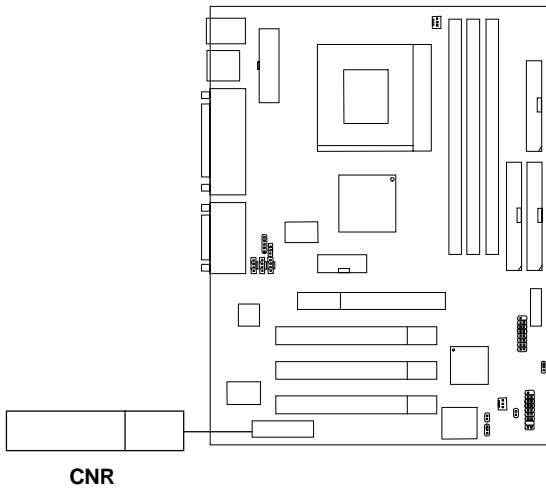

2.26 USB Front Connector: JUSB1

The mainboard provides a **front Universal Serial Bus connector**. This is an optional USB connector for Front Panel.

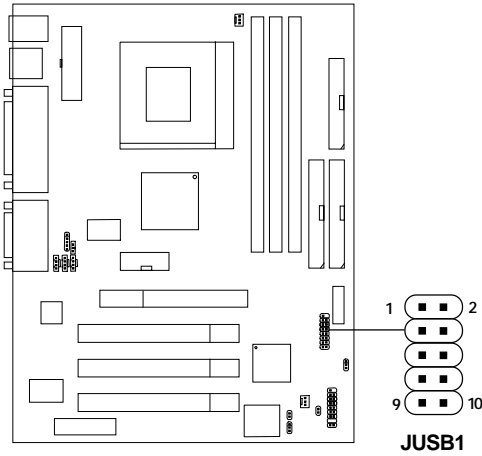

Pin	Description	Pin	Description
1	VCC	6	GND
2	USB3-	7	GND
3	USBD3+	8	USBD2+
4	GND	9	USB2-
5	GND	10	VCC

Chapter 3

AWARD® BIOS SETUP

Award® BIOS ROM has a built-in Setup program that allows users to modify the basic system configuration. This type of information is stored in battery-backed RAM (CMOS RAM), so that it retains the Setup information when the power is turned off.

3.1 Entering Setup

Power on the computer and press immediately to allow you to enter Setup. The other way to enter Setup is to power on the computer. When the below message appears briefly at the bottom of the screen during the POST (Power On Self Test), press key or simultaneously press <Ctrl>, <Alt>, and <Esc> keys.

TO ENTER SETUP BEFORE BOOT, PRESS <CTRL-ALT-ESC>
OR KEY

If the message disappears before you respond and you still wish to enter Setup, restart the system to try again by turning it OFF then ON or pressing the “RESET” button on the system case. You may also restart by simultaneously pressing <Ctrl>, <Alt>, and <Delete> keys. If you do not press the keys at the correct time and the system does not boot, an error message will be displayed and you will again be asked to,

PRESS <F1> TO CONTINUE, <CTRL-ALT-ESC>
OR TO ENTER SETUP

3.2 Getting Help

Main Menu

The on-line description of the highlighted setup function is displayed at the bottom of the screen.

Status Page Setup Menu/Option Page Setup Menu

Press F1 to pop up a small help window that describes the appropriate keys to use and the possible selections for the highlighted item. To exit the Help Window, press <Esc>.

Integrated Peripherals

Use this menu to specify your settings for integrated peripherals.

Power Management Setup

Use this menu to specify your settings for power management.

PnP/PCI Configurations

This entry appears if your system supports PnP/PCI.

PC Health Status (Optional)

This entry shows your PC health status. This is only available if there is Hardware Monitor onboard.

Frequency/Voltage Control

Use this menu to specify your settings for frequency/voltage control.

Load Fail-Safe Defaults

Use this menu to load the BIOS default values for the minimal/stable performance for your system to operate.

Load Optimized Defaults

Use this menu to load the BIOS default values that are factory settings for optimal performance system operations.

Set Supervisor/User Password

Use this menu to set User and Supervisor Passwords.

Save & Exit Setup

Save CMOS value changes to CMOS and exit setup.

Exit Without Saving

Abandon all CMOS value changes and exit setup.

3.4 Standard CMOS Features

The items in Standard CMOS Setup Menu are divided into 10 categories. Each category includes no, one or more than one setup items. Use the arrow keys to highlight the item and then use the <PgUp> or <PgDn> keys to select the value you want in each item.

CMOS Setup Utility - Copyright(C) 1984-2000 Award Software
Standard CMOS Features

Date(mm:dd:yy):	Fri, Feb 28,1999	Item Help
Time(hh:mm:ss):	00:00:00	
IDE Primary Master	Press Enter 2557MB	Menu Level >
IDE Primary Slave	Press Enter None	
IDE Secondary Master	Press Enter None	
IDE Secondary Slave	Press Enter None	
Drive A	1.44M, 3.5in.	
Drive B	None	
Video	EGA/VGA	
Halt On	All Errors	
Based Memory	640K	
Extended Memory	64512K	
Total Memory	65536K	
↑↓ →← Move Enter:Select +/-/PU/PD:Value F10:Save ESC:Exit F1:General Help F5:Previous Values F6:Fail-Safe Defaults F7:Optimized Defaults		

Date

The date format is <day><month> <date> <year>.

Day	Day of the week, from Sun to Sat, determined by BIOS. Read-only.
month	The month from Jan. through Dec.
date	The date from 1 to 31 can be keyed by numeric function keys.
year	The year, depends on the year of the BIOS

Time

The time format is <hour> <minute> <second>.

PrimaryMaster/PrimarySlave**SecondaryMaster/Secondary Slave**

Press PgUp/<+> or PgDn/<-> to select Manual, None, Auto type.

Note that the specifications of your drive must match with the drive table. The hard disk will not work properly if you enter improper information for this category. If your hard disk drive type is not matched or listed, you can use Manual to define your own drive type manually.

If you select Manual, related information is asked to be entered to the following items. Enter the information directly from the keyboard. This information should be provided in the documentation from your hard disk vendor or the system manufacturer.

If the controller of HDD interface is SCSI, the selection shall be
“None”.

If the controller of HDD interface is CD-ROM, the selection shall be
“None”.

Access Mode	The settings are Auto, Normal, Large,LBA.
Cylinder	number of cylinders
Head	number of heads
Precomp	write precomp
Landing Zone	landing zone
Sector	number of sectors

3.5 Advanced BIOS Features

CMOS Setup Utility - Copyright(C) 1984-2000 Award Software
Advanced BIOS Features

Anti-Virus Protection	Disabled	Item Help
CPU Internal Cache	Enabled	
External Cache	Enabled	Menu Level >
CPU L2 Cache ECC Checking	Enabled	
Processor Number Feature	Enabled	
Quick Power On Self Test	Disabled	
First Boot Device	Floppy	
Second Boot Device	HDD-0	
Third Boot Device	LS/Zip	
Fourth Boot Device	Disabled	
Swap Floppy Drive	Disabled	
Boot Up Floppy Seek	Disabled	
Boot Up Numlock Status	Off	
Gate A20 Option	Fast	
Typeomatic Rate Setting	Disabled	
Typeomatic Rate (Chars/Sec)	6	
Typeomatic Delay (Msec)	250	
Security Option	Setup	
OS Select for DRAM > 64MB	Non-OS2	
HDD S.M.A.R.T Capability	Disabled	
Report No FDD for Win 95	No	
↑ ↓ → ← Move Enter:Select +/-/PU/PD:Value F10:Save ESC:Exit F1:General Help F5:Previous Values F6:Fail-safe defaults F7:Optimized Defaults		

Anti-Virus Protection

Allows you to choose the VIRUS Warning feature for IDE Hard Disk boot sector protection. If this function is enabled and someone attempt to write data into this area, BIOS will show a warning message on screen and alarm beep.

Disable(default) No warning message to appear when anything attempts to access the boot sector or hard disk partition table.

Enable Activates automatically when the system boots up causing a warning message to appear when anything attempts to access the boot sector of hard disk partition table.

CPU Internal Cache

The default value is Enabled.

Enabled (default) Enable cache

Disabled Disable cache

Note: The internal cache is built in the processor.

External Cache

Choose Enabled or Disabled. This option enables the level 2 cache memory.

CPU L2 Cache ECC Checking

Choose Enabled or Disabled. This option enables the level 2 cache memory ECC(error check correction).

Processor Number Feature

This option is for Pentium® III processor. During Enabled, this will check the CPU Serial number. Disabled this option if you don't want the system to know the Serial number.

Quick Power On Self Test

This category speeds up Power On Self Test (POST) after you power on the computer. If this is set to Enabled, BIOS will shorten or skip some check items during POST.

Enabled Enable quick POST

Disabled (default) Normal POST

First/Second/Third/Fourth Boot Device

The BIOS attempts to load the operating system from the devices in the sequence selected in these items. The settings are Floppy, LS/ZIP, HDD-0/HDD-1/HDD-2/HDD-3, SCSI, CDROM, LAN, and Disabled.

Swap Floppy Drive

Switches the floppy disk drives between being designated as A and B. Default is Disabled.

Boot Up Floppy Seek

During POST, BIOS will determine if the floppy disk drive installed is 40 or 80 tracks. 360K type is 40 tracks while 760K, 1.2M and 1.44M are all 80 tracks.

Boot Up NumLock Status

The default value is On.

On (default) Keypad is numeric keys.

Off Keypad is arrow keys.

Gate A20 Option

Normal The A20 signal is controlled by keyboard controller or chipset hardware.

Fast(default) The A20 signal is controlled by port 92 or chipset specific method.

Typematic Rate Setting

Key strokes repeat at a rate determined by the keyboard controller. When enabled, the typematic rate and typematic delay can be selected. The settings are: Enabled/Disabled.

Typematic Rate (Chars/Sec)

Sets the number of times a second to repeat a key stroke when you hold the key down. The settings are: 6, 8, 10, 12, 15, 20, 24, 30.

Typematic Delay (Msec)

Sets the delay time after the key is held down before it begins to repeat the keystroke. The settings are: 250, 500, 750, 1000.

Security Option

This category allows you to limit access to the system and Setup, or just to Setup.

- | | |
|-----------------------|---|
| System | The system will not boot and access to Setup will be denied if the correct password is not entered at the prompt. |
| Setup(default) | The system will boot, but access to Setup will be denied if the correct password is not entered at the prompt. |

OS Select For DRAM > 64MB

Allows OS2® to be used with > 64 MB of DRAM. Settings are Non-OS/2 (default) and OS2. Set to OS/2 if using more than 64MB and running OS/2®.

Report No FDD For Win 95

Whether report no FDD for Win 95 or not. The settings are: Yes, No.

3.6 Advanced Chipset Features

The Advanced Chipset Features Setup option is used to change the values of the chipset registers. These registers control most of the system options in the computer.

Choose the “ADVANCED CHIPSET FEATURES” from the Main Menu and the following screen will appear.

CMOS Setup Utility - Copyright(C) 1984-2000 Award Software
Advanced Chipset Features

SDRAM CAS Latency Time	3	Item Help
SDRAM Cycle Time Tras/Trc	6/8	
SDRAM RAS-to-CAS Delay	1	
SDRAM RAS Precharge Time	3	
System BIOS Cacheable	Disabled	
Video BIOS Cacheable	Disabled	Menu Level >
Memory Hole at 15M-16M	Disabled	
CPU Latency Timer	Disabled	
Delayed Transaction	Disabled	
On-Chip Video Window Size	Enabled	
AGP Graphics Aperture Size	64MB	
System Memory Frequency	Auto	
↑↓ →← Move Enter:Select +/-/PU/PD:Value F10:Save ESC:Exit F1:General Help F5:Previous Values F6:Fail-safe defaults F7:Optimized Defaults		

Note: Change these settings only if you are familiar with the chipset.

SDRAM CAS Latency Time

When synchronous DRAM is installed, the number of clock cycles of CAS latency depends on the DRAM timing. The settings are: 2 and 3.

SDRAM Cycle Time *Tras*/*Trc*

Select the number of SCLKs for an access cycle. The settings are: 5/7 and 6/8.

SDRAM RAS-to-CAS Delay

This field lets you insert a timing delay between the CAS and RAS strobe signals, used when DRAM is written to, read from, or refreshed. *Fast* gives faster performance; and *Slow* gives more stable performance. This field applies only when synchronous DRAM is installed in the system. The settings are: 2 and 3.

SDRAM RAS Precharge Time

If an insufficient number of cycles is allowed for the RAS to accumulate its charge before DRAM refresh, the refresh may be incomplete and the DRAM may fail to retain data. *Fast* gives faster performance; and *Slow* gives more stable performance. This field applies only when synchronous DRAM is installed in the system. The settings are: 2 and 3.

System BIOS Cacheable

Selecting *Enabled* allows caching of the system BIOS ROM at F0000h-FFFFFh, resulting in better system performance. However, if any program writes to this memory area, a system error may result. The settings are: Enabled and Disabled.

Video BIOS Cacheable

Select Enabled allows caching of the video BIOS , resulting in better system performance. However, if any program writes to this memory area, a system error may result. The settings are: Enabled and Disabled.

Memory Hole At 15M-16M

You can reserve this area of system memory for ISA adapter ROM. When this area is reserved, it cannot be cached. The user information of peripherals that need to use this area of system memory usually discusses their memory requirements. The settings are: Enabled and Disabled.

CPU Latency Timer

During Enabled, A deferrable CPU cycle will only be Deferred after it has been in a Snoop Stall for 31 clocks and another ADS# has arrived. During Disabled, A deferrable CPU cycle will be Deferred immediately after the GMCH receives another ADS#.

Delayed Transaction

The chipset has an embedded 32-bit posted write buffer to support delay transactions cycles. Select *Enabled* to support compliance with PCI specification version 2.1. The settings are: Enabled and Disabled.

On-Chip Video Window Size

This option enabled/disabled the on-chip video window size for VGA driver use. The settings are: Enabled, Disabled.

AGP Graphics Aperture Size

This option determines the effective size of the graphics aperture used in the particular PAC configuration. The AGP aperture is memory-mapped, while graphics data structure can reside in a graphics aperture. The aperture range should be programmed as not cacheable in the processor cache, accesses with the aperture range are forwarded to the main memory, then PAC will translate the original issued address via a translation table that is maintained on the main memory. The option allows the selection of an aperture size of 4MB, 8MB, 16MB, 32MB, 64MB, 128MB, and 256MB.

System Memory Frequency

Select the Onboard Display Cache frequency.

3.7 Integrated Peripherals

CMOS Setup Utility - Copyright(C) 1984-2000 Award Software
Integrated Peripherals

On-Chip Primary PCI IDE	Enabled	Item Help
On-Chip Secondary PCI IDE	Enabled	
IDE Primary Master PIO	Auto	Menu Level >
IDE Primary Slave PIO	Auto	
IDE Secondary Master PIO	Auto	
IDE Secondary Slave PIO	Auto	
IDE Primary Master UDMA	Auto	
IDE Primary Slave UDMA	Auto	
IDE Secondary Master UDMA	Auto	
IDE Secondary Slave UDMA	Auto	
USB Controller	Enabled	
USB Keyboard Support	Disabled	
Init Display First	PCI Slot	
AC97 Audio	Disabled	
IDE HDD Block Mode	Enabled	
Power On Function		
KB Power On Password		
Hot Key Power ON		
Onboard FDC Controller	Enabled	
Onboard Serial Port 1	3F8/IRQ4	
Onboard Serial Port 2	2F8/IRQ3	
↑ ↓ → ← Move Enter:Select +/-/PU/PD:Value F10:Save ESC:Exit F1:General Help F5:Previous Values F6:Fail-safe defaults F7:Optimized Defaults		

UART Mode Select	Normal	
RxD, TxD Active	Hi, Lo	
IR Transmission Delay	Enabled	
UR2 Duplex Mode	Half	
USE IR Pins	IR-Rx2Tx2	
Onboard Parallel Port	378/IRQ7	
Parallel Port Mode	SPP	
EPP Mode Select	EPP 1.7	
ECP Mode use DMA	3	
PWRON After PWR-Fail	Off	
Game Port Address	Disabled	
Midi Port Address	Disabled	
Midi Port IRQ	5	
Power Status LED	Blinking	

On-Chip Primary/Secondary PCI IDE

The integrated peripheral controller contains an IDE interface with support for two IDE channels. Select *Enabled* to activate each channel separately. The settings are: Enabled and Disabled.

IDE Primary/Secondary Master/Slave PIO

The four IDE PIO (Programmed Input/Output) fields let you set a PIO mode (0-4) for each of the four IDE devices that the onboard IDE interface supports. Modes 0 through 4 provide successively increased performance. In Auto mode, the system automatically determines the best mode for each device. The settings are: Auto, Mode 0, Mode 1, Mode 2, Mode 3, Mode 4.

IDE Primary/Secondary Master/Slave UDMA

Ultra DMA/33 implementation is possible only if your IDE hard drive supports it and the operating environment includes a DMA driver (Windows 95 OSR2 or a third-party IDE bus master driver). If your hard drive and your system software both support Ultra DMA/33 and Ultra DMA/66, select Auto to enable BIOS support. The settings are: Auto, Disabled.

USB Controller

Select *Enabled* if your system contains a Universal Serial Bus (USB) controller and you have USB peripherals. The settings are: Enabled, Disabled.

USB Keyboard Support

Select *Enabled* if your system contains a Universal Serial Bus (USB) controller and you have a USB keyboard. The settings are: Enabled, Disabled.

Init Display First

This item allows you to decide to activate whether PCI Slot or on-chip VGA first. The settings are: PCI Slot, Onboard.

AC97 Audio

This item allows you to decide to enable/disable the 815 chipset family to support AC97 Audio. The settings are: Enabled, Disabled.

IDE HDD Block Mode

Block mode is also called block transfer, multiple commands, or multiple sector read/write. If your IDE hard drive supports block mode (most new drives do), select Enabled for automatic detection of the optimal number of block read/writes per sector the drive can support. The settings are: Enabled, Disabled.

Power On Function

This function allows you to select the item to power on the system. The settings are : Button Only, Mouse Left, Mouse Right, Password, Hotkey, keyboard 98.

Onboard FDC Controller

Select Enabled if your system has a floppy disk controller (FDD) installed on the system board and you wish to use it. If you install add-on FDC or the system has no floppy drive, select Disabled in this field. The settings are: Enabled and Disabled.

Onboard Serial Port 1/Port 2

Select an address and corresponding interrupt for the first and second serial ports. The settings are: 3F8/IRQ4, 2E8/IRQ3, 3E8/IRQ4, 2F8/IRQ3, Disabled, Auto.

UART Mode Select

This item allows you to determine which InfraRed(IR) function of the onboard I/O chip, this functions uses.

Onboard Parallel Port

Disabled
(3BCH/IRQ7)/
(278H/IRQ5)/
(378H/IRQ7)

There is a built-in parallel port on the on-board Super I/O chipset that provides Standard, ECP, and EPP features. It has the following options:

Disable
3BCH/IRQ7 Line Printer port 0
278H/IRQ5 Line Printer port 2
378H/IRQ7 Line Printer port 1

Onboard Parallel Mode

SPP : Standard Parallel Port
EPP : Enhanced Parallel Port
ECP : Extended Capability Port

**SPP/EPP/ECP/
ECP+EPP**

To operate the onboard parallel port as Standard Parallel Port only, choose "SPP." To operate the onboard parallel port in the EPP modes simultaneously, choose "EPP." By choosing "ECP", the onboard parallel port will operate in ECP mode only. Choosing "ECP + EPP" will allow the onboard parallel port to support both the ECP and EPP modes simultaneously. The ECP mode has to use the DMA channel, so choose the onboard parallel port with the ECP feature. After selecting it, the following message will appear: "ECP Mode Use DMA" At this time, the user can choose between DMA

channels 3 or 1. The onboard parallel port is EPP Spec. compliant, so after the user chooses the onboard parallel port with the EPP function, the following message will be displayed on the screen: "EPP Mode Select." At this time either EPP 1.7 spec. or EPP 1.9 spec. can be chosen.

PWRON After PWR-Fail

This option will determine how the system will power on after a power failure.

Game Port Address/Midi Port Address

This will determine which Address the Game Port/Midi Port will use.

Power Status LED

This item determines which state the Power LED will use. The settings are Blinking, Dual, and Single. During blinking, the power LED will blink when the system enters the suspend mode. When the mode is in Dual, the power LED will change its color. Choose the single and the power LED will always remain lit.

3.8 Power Management Setup

The Power Management Setup allows you to configure you system to most effectively save energy while operating in a manner consistent with your own style of computer use.

CMOS Setup Utility - Copyright(C) 1984-2000 Award Software
Power Management Setup

ACPI Function	Enabled	Item Help	
ACPI Suspend Type	S1(POS)		
Power Management	User Define	Menu Level >	
Video Off Method	DPMS		
Video Off In Suspend	Yes		
Suspend Type	Stop Grant		
Modem Use IRQ	3		
Suspend Mode	Disabled		
HDD Power Down	Disabled		
Soft-Off by PWR-BTTN	Instant-Off		
Wake Up by PCI Card	Disabled		
Power On by Ring	Disabled		
Wake-Up on LAN	Disabled		
CPU Thermal-Throtting	62.57%		
Resume by Alarm	Disabled		
Date(of Month) Alarm	0		
Date(hh:mm:ss) Alarm	0 0 0		
Reload Global Timer Events			
Primary IDE 0	Disabled		
Primary IDE 1	Disabled		
Secondary IDE 0	Disabled		
Secondary IDE 1	Disabled		
FDD, COM, LPT Port	Disabled		
PCI IRQ[A-D]#	Disabled		
↑ ↓ → ← Move Enter:Select +/-/PU/PD:Value F10:Save ESC:Exit F1:General Help F5:Previous Values F6:Fail-safe defaults F7:Optimized Defaults			

ACPI Function

This item allows you to Enabled/Disabled the Advanced Configuration and Power Management (ACPI). The settings are Enabled and Disabled.

ACPI Suspend Type

This item will set which ACPI suspend type will be used.

S1 (POS)

The S1 sleeping state is low wake-up latency sleeping state. In this state, no system context is lost(CPU or chip set) and hardware maintains all system context.

S3 (STR)

The S3 state is a low wake-up latency sleeping state where all system context is lost except system memory. CPU, cache, and chipset context are lost in this state. Hardware maintains memory context and restores some CPU and L2 configuration context.

Power Management

This category allows you to select the type (or degree) of power saving and is directly related to the following modes:

1. Suspend Mode
2. HDD Power Down

There are three selections for Power Management, two of which have fixed mode settings.

Min Saving	Minimum power management. Suspend Mode = 1 hr., and HDD Power Down = 15 min.
Max Saving	Maximum power management — Suspend Mode = 1 min., and HDD Power Down = 1 min.
User Define (default)	Allows you to set each mode individually. When not disabled, each of the ranges are from 1 min. to 1 hr. except for HDD Power Down which ranges from 1 min. to 15 min. and disable.

Video Off Method

This determines the manner in which the monitor is blanked.

V/HSYNC+Blank	This selection will cause the system to turn off the vertical and horizontal synchronization ports and write blanks to the video buffer.
Blank Screen	This option only writes blanks to the video buffer.
DPMS (default)	Initial display power management signaling.

Video Off In Suspend

This determines the manner in which the monitor is blanked.
The settings are: Yes and No.

Suspend Type

Select the Suspend Type. The settings are: PWRON Suspend, Stop Grant.

Modem Use IRQ

This determines the IRQ in which the MODEM can use.
The settings are: 3, 4, 5, 7, 9, 10, 11, NA.

Suspend Mode

When enabled and after the set time of system inactivity, all devices except the CPU will be shut off. The settings are: 1/2/4/8/12/20/30/40 Min, 1 Hour, and Disabled.

HDD Power Down

When enabled and after the set time of system inactivity, the hard disk drive will be powered down while all other devices remain active.
The settings are: 1/2/3/4/5/6/7/8/9/10/11/12/13/14/15Min and Disabled.

Soft-Off by PWR-BTTN

Pressing the power button for more than 4 seconds forces the system to enter the Soft-Off state. The settings are: Delay 4 Sec, Instant-Off.

Wake Up by PCI card

This will enable the system to wake up through PCI Card peripheral.
The settings are : Enabled and Disabled.

Power On by Ring

During Disabled, the system will ignore any incoming call from the modem. During Enabled, the system will boot up if there's an incoming call from the modem.

Wake Up on LAN

To use this function, you need a LAN add-on card which support power on functions. It should also support the wake-up on LAN jumper (JWOL1).

Enabled	Wake up on LAN supported.
Disabled	Wake up on LAN not supported.

CPU Thermal-Throttling

Select the CPU THRM-Throttling rate. The settings are: 12.5%, 25.0%, 37.5%, 50.0%, 62.5%, 75.0%, 87.5%.

Resume by Alarm

This function is for setting date and time for your computer to boot up. During Disabled, you cannot use this function. During Enabled, choose the Date and Time Alarm:

Date(of month) Alarm	You can choose which month the system will boot up. Set to 0, to boot every day.
Time(hh:mm:ss) Alarm	You can choose what hour, minute and second the system will boot up.

Note: If you have change the setting, you must let the system boot up until it goes to the operating system, before this function will work.

Reload Global Timer Events

Reload Global Timer events are I/O events whose occurrence can prevent the system from entering a power saving mode or can awaken the system from such a mode. In effect, the system remains alert for anything which occurs to a device which is configured as *Enabled* , even when the system is in a power down mode.

Primary IDE 0

Primary IDE 1

Secondary IDE 0

Secondary IDE 1

FDD, COM, LPT Port

PCIPIRQ[A-D]#

3.9 PnP/PCI Configuration Setup

This section describes configuring the PCI bus system. PCI, or **P**ersonal **C**omputer **I**nterconnect, is a system which allows I/O devices to operate at speeds nearing the speed the CPU itself uses when communicating with its own special components. This section covers some very technical items and it is strongly recommended that only experienced users should make any changes to the default settings.

CMOS Setup Utility - Copyright(C) 1984-2000 Award Software
PnP/PCI Configurations

Reset Configuration Data	Disabled	Item Help
Resources Controlled By	Auto(ESCD)	
IRQ Resources	Press Enter	
DMA Resources	Press Enter	
PCI/VGA Palette Snoop	Disabled	Menu Level >
INT Pin1 Assignment	Auto	
INT Pin2 Assignment	Auto	
INT Pin3 Assignment	Auto	
INT Pin4 Assignment	Auto	
↑ ↓ → ← Move Enter:Select +/-/PU/PD=Value F10:Save ESC:Exit F1:General Help F5:Previous Values F6:Fail-safe defaults F7:Optimized Defaults		

Reset Configuration Data

Normally, you leave this field Disabled. Select Enabled to reset Extended System Configuration Data (ESCD) when you exit Setup if you have installed a new add-on and the system reconfiguration has caused such a serious conflict that the operating system can not boot. The settings are: Enabled and Disabled .

Resource Controlled By

The Award Plug and Play BIOS has the capacity to automatically configure all of the boot and Plug and Play compatible devices. However, this capability means absolutely nothing unless you are using a Plug and Play operating system such as Windows®95/98. If you set this field to “manual” choose specific resources by going into each of the sub menu that follows this field (a sub menu is preceded by a “>”). The settings are: Auto(ESCD), Manual.

IRQ Resources

When resources are controlled manually, assign each system interrupt a type, depending on the type of device using the interrupt.

DMA Resources

This sub menu can let you control the DMA resource.

PCI/VGA Palette Snoop

Leave this field at *Disabled*. The settings are Enabled, Disabled.

3.10 PC Health Status (optional)

This section shows the Status of you CPU, Fan, Warning for overall system status. This is only available if there is Hardware Monitor onboard.

CMOS Setup Utility - Copyright(C) 1984-2000 Award Software
 PC Health Status

CPU Warning Temperature	Disabled	Item Help	
Current System Temp	39°C/102°F		
Current CPU Temperature	66°C/150°C	Menu Level >	
Current System Fan	0RPM		
Current CPU Fan	5532RPM		
Vcore	1.96V		
VTT	1.48V		
3.3V	3.24V		
+5V	4.89V		
+12V	11.79V		
-12V	-12.19V		
-5V	-4.53V		
VBAT(V)	3.10V		
5VSB(V)	5.37V		
Shutdown Temperature	Disabled		
↑↓ →← Move Enter:Select +/-/PU/PD:Value F10:Save ESC:Exit F1:General Help F5:Previous Values F6:Fail-safe defaults F7:Optimized Defaults			

CPU Warning Temperature

During Enabled, this will warn the user when the CPU temperature reach a certain temperature.

Current System Temp/Current CPU Temperature/Current System Fan (optional)/CPU Fan/Vcore/VTT/3.3V/+5V/+12V/-12V/-5V/VBAT(V)/5VSB(V)

This will show the CPU/FAN/System voltage chart and FAN Speed.

Shutdown Temperature

This option is for setting the Shutdown temperature level for the processor. When the processor reach the temperature you set, this will shutdown the system.

3.11 Frequency/Voltage Control

This section is for setting CPU Frequency/Voltage Control.

CMOS Setup Utility - Copyright(C) 1984-2000 Award Software
 Frequency/Voltage Control

Auto Detect DIMM/PCI Clk	Enabled	Item Help
Spread Spectrum	Enabled	
CPU Clock Ratio	Auto	
		Menu Level >
↑↓ →← Move Enter:Select +/-/PU/PD:Value F10:Save ESC:Exit F1:General Help F5:Previous Values F6:Fail-safe defaults F7:Optimized Defaults		

Auto Detect DIMM/PCI Clk

This item allows you to enable/disable auto detect DIMM/PCI Clock.
 The settings are: Enabled, Disabled.

Spread Spectrum

This item allows you to set the Spread Spectrum.

CPU Clock Ratio

This item allows you to select the CPU ratio.

3.12 Load Fail-Safe/Optimized Defaults

Load Fail-Safe Defaults

When you press <Enter> on this item, you get a confirmation dialog box with a message similar to:

Load Fail-Safe Defaults (Y/N) ? N

Pressing 'Y' loads the BIOS default values for the most stable, minimal-performance system operations.

Load Optimized Defaults

When you press <Enter> on this item, you get a confirmation dialog box with a message similar to:

Load Optimized Defaults (Y/N) ? N

Pressing 'Y' loads the default values that are factory settings for optimal performance system operations.

3.13 Set Supervisor/User Password

You can set either supervisor or user password, or both of them. The differences are:

Supervisor password : Can enter and change the options of the setup menus.

User password : Can only enter but do not have the right to change the options of the setup menus. When you select this function, the following message will appear at the center of the screen to assist you in creating a password.

ENTER PASSWORD:

Type the password, up to eight characters in length, and press <Enter>. The password typed now will clear any previously entered password from CMOS memory. You will be asked to confirm the password. Type the password again and press <Enter>. You may also press <Esc> to abort the selection and not enter a password.

To disable a password, just press <Enter> when you are prompted to enter the password. A message will confirm the password will be disabled. Once the password is disabled, the system will boot and you can enter Setup freely.

PASSWORD DISABLED.

When a password has been enabled, you will be prompted to enter it every time you try to enter Setup. This prevents an unauthorized person from changing any part of your system configuration.

Additionally, when a password is enabled, you can also require the BIOS to request a password every time your system is rebooted. This would prevent unauthorized use of your computer.

You determine when the password is required within the BIOS Features Setup Menu and its Security option. If the Security option is set to “System”, the password will be required both at boot and at entry to Setup. If set to “Setup”, prompting only occurs when trying to enter Setup.

Chapter 4

AMI® BIOS USER'S GUIDE

The system configuration information and chipset register information is stored in the CMOS RAM. This information is retained by a battery when the power is off. Enter the BIOS setup (if needed) to modify this information.

The following pages will describe how to enter BIOS setup, and all about options.

4.1 Enter BIOS Setup

Enter the AMI® setup Program's Main Menu as follows:

1. Turn on or reboot the system. The following screen appears with a series of diagnostic check.

```
AMIBIOS (C) 1999 American Megatrends Inc.  
AGIOMS VXXX XXXXXX
```

```
Hit <DEL> if you want to run setup
```

```
(C) American Megatrends Inc.  
61-XXXX-001169-00111111-071592-i82440FX-H
```

2. When the "Hit " message appears, press key to enter the BIOS setup screen.
3. After pressing key, the BIOS setup screen will appear.

Note: *If you don't want to modify CMOS original setting, then don't press any key during the system boot.*

```
AMIBIOS HIFLEX SETUP UTILITIES - VERSION 1.22
(C) 1999 American Megatrends, Inc. All Rights
Reserved

Standard CMOS Setup
Advanced CMOS Setup
Advanced Chipset Setup
Power Management Setup
PCI/Plug and Play Setup
Peripheral Setup
Hardware Monitor Setup
Auto-Detect Hard Disks
Change User Password
Change Supervisor Password
Change Language Setting
Auto Configuration with Optimal Settings
Auto Configuration with Fail Safe Settings
Save Settings and Exit
Exit without Saving

Standard CMOS setup for changing time, hard disk type, etc.
```

4. Use the <Up> and <Down> key to move the highlight scroll up or down.
5. Use the <ENTER> key to select the option.
6. To exit, press <ESC>. To save and exit, press <F10>.
7. Section 4.2 to 4.8 will explain the option in more details.

4.2 Standard CMOS Setup

1. Press <ENTER> on “Standard CMOS Setup” of the main menu screen .

```

AMIBIOS SETUP - STANDARD CMOS SETUP
(C)1999 American Megatrends, Inc. All Rights Reserved

```

```

Date (mm/dd/yyyy):    Fri March 20, 1999
Time (hh/mm/ss):     17:09:25

Floppy Drive A:      1.44 MB 3 1/2
Floppy Drive B:      Not Installed

```

	Type	Size	Cyln	Head	WPcom	Sec	LBA Mode	Blk Mode	PIO Mode	32Bit Mode
Pri Master	:Auto						ON	ON	AUTO	ON
Pri Slave	:Auto						ON	ON	AUTO	ON
Sec Master	:Auto						ON	ON	AUTO	ON
Sec Slave	:Auto						ON	ON	AUTO	ON

```

Boot Sector Virus Protection Disabled

```

```

Month : Jan-Dec          ESC:Exit      :Sel
Day   : 01-31           PgUp/PgDn:Modify
Year  : 1901-2099      F2/F3:Color

```

2. Use <Up> and <Down> to choose the item and <PgUp> and <PgDn> keys to modify the highlighted item.
3. After you have finished with the Standard CMOS Setup, press <ESC> to go back to the main menu.

4.3 Advanced CMOS Setup

1. Press <ENTER> on “Advanced CMOS Setup” of the main menu

AMIBIOS SETUP - ADVANCED CMOS SETUP		
(C) 1999 American Megatrends, Inc. All Rights Reserved		
Quick Boot	Enabled	Available Options: Disabled Enabled
1st Boot Device	Floppy	
2nd Boot Device	IDE 0	
3rd Boot Device	CD-ROM	
Try Other Boot Devices	Yes	
Initial Display Mode	BIOS	
Display Mode at Add-On ROM Init	Force-BIOS	
Floppy Access Control	Read-Write	
S.M.A.R.T. For Hard Disk	Disabled	
BootUp Num-Lock	On	
Floppy Drive Swap	Disabled	
Floppy Drive Seek	Disabled	
PS/2 Mouse Support	Enabled	
Primary Display	VGA/EGA	
Password Check	Setup	
Boot to OS/2 > 64M	No	
CPU Serial Number	Disabled	
Cache Bus ECC	Enabled	
System BIOS Cacheable	Disabled	
C000, 64k Shadow	Disabled	
		ESC:Exit :Sel PgUp/PgDn:Modify F2/F3:Color

2. Use <Up> and <Down> to choose the item and <PgUp> and <PgDn> keys to modify the highlighted item.
3. After you have finished with the Advanced CMOS Setup, press <ESC> to go back to the main menu.

Description of the item on screen follows:**Quick Boot**

Set this option to Enabled to permit AMI® BIOS to boot within 5 seconds. This option replaces the old ABOVE 1 MB Memory Test option. The Optimal default setting is Enabled. The Fail-Safe default setting is Disabled.

1st Boot Device/2nd Boot Device/3rd Boot Device

This option sets the sequence of boot drives.

The settings are:

IDE0	The system will boot from the first HDD.
IDE1	The system will boot from the Second HDD.
IDE2	The system will boot from the Third HDD.
IDE3	The system will boot from the Fourth HDD.
F(optical)	The system will boot from LS-120(120M Floppy).
SCSI	The system will boot from the SCSI.
Network	The system will boot from the Network drive.
CD-ROM	The system will boot from the CD-ROM.
Disable	Disable this sequence.

Try other Boot Devices

This option sets the device boot, if all the Four Boot Devices failed.

Initial Display Mode

This option sets the device boot, if all the Four Boot Devices failed.

Display Mode at Add-On ROM Init

This option sets the device boot, if all the Four Boot Devices failed.

Floppy Access Control

This option sets the Floppy to Read-only or Read-Write.

S.M.A.R.T. for Hard Disks

This option sets the SMART Function for the hard disk. The hard disk need to have SMART function for this feature to work.

Boot up Num Lock

When this option is set to Off, AMI® BIOS turns off the Num Lock key when the system is powered on. The end user can then use the arrow keys on both the numeric keypad and the keyboard. The settings are On or Off. The optimal default and Fail-Safe default settings are On.

Floppy Drive Swap

Set this option to Enabled to specify that floppy drives A: and B: are swapped. The setting are Enabled and Disabled. The Optimal and Fail-Safe default settings are Disabled.

Floppy Drive Seek

When this option is set to Enabled, AMI® BIOS performs a Seek command on floppy drive A: before booting the system. The settings are Enabled and Disabled. The Optimal and Fail-Safe default settings are Disabled.

PS/2® Mouse Support

When this option is set to Enabled, AMI® BIOS supports a PS/2® mouse. The settings are Enabled and Disabled. The Optimal and Fail-Safe default settings are Enabled.

Primary Display

This option configures the primary display subsystem in the computer. The settings are Mono(monochrome), 40CGA, 80CGA or VGA/EGA. The optimal and Fail-Safe default settings are VGA/EGA.

Password Check

This option specifies the type of AMI® BIOS password protection that is implemented. The Optimal and Fail-Safe default settings are Setup.

Boot To OS/2® > 64MB

Set this option to Enabled to permit the BIOS to run properly, if OS/2® is to be used with > 64MB of DRAM. The settings are Enabled or Disabled. The Optimal and Fail-safe default settings are Disabled.

CPU Serial Number

This option is for Pentium III processor. During Enabled, this will check the CPU Serial number. Disabled this option if you don't want the system to know the Serial number.

Cache Bus ECC

This option is for Pentium® II processor. During Enabled, this will affect the system performance. Disabled this option if you don't want to affect the system performance.

System BIOS Cacheable

AMI® BIOS always copies the system BIOS from ROM to RAM for faster execution. Set this option to Enabled to permit the contents of the F0000h RAM memory segment to be written to and read from cache memory. The settings are Enabled or Disabled. The Optimal default setting is Enabled. The Fail-Safe default setting is Disabled.

C000, 64K Shadow

These options specify how the contents of the video ROM are handled. The settings are:

Disabled - the Video ROM is not copied to RAM.

Cached - the contents of the video ROM from C0000h - C7FFFh are not only copied from ROM to RAM; it can also be written to or read from cache memory.

Shadow - the Contents of the video ROM from C0000h - C7FFFh are copied(shadowed) from ROM to RAM for faster execution.

The Optimal and Fail-Safe default setting is Cached.

4.4 Advanced Chipset Setup

1. Press <ENTER> on “Advanced Chipset Setup” of the main menu screen.

AMIBIOS SETUP - ADVANCED CHIPSET SETUP (C) 1999 American Megatrends, Inc. All Rights Reserved		
USB Function	Enabled	Available Options: Disabled
USB Keyboard Legacy Support	Disabled	
CPU Latency Timer	Disabled	Enabled
DRAM Page Closing Policy	Closed	
CD Hole (DC000h - DFFFh)	Disabled	
Memory Hole	Disabled	
DRAM Tras/Trc Cycle Time(SCLKs)	6/8	
Address Setup Time(SCLKs)	1	
CAS# Latency(SCLKs)	3	
SDRAM RAS# to CAS# Delay(SCLKs)	3	
SDRAM RAS# Precharge	3	
Graphics Mode Select	UMA 1MB	
Display Cache Window Size	64MB	
CPU BIST Enable	Disabled	
ICH Delayed Transaction	Disabled	
ICH DCB Enable	Disabled	
****Display Cache Function****		
Initialize Display Cache Memory	Enabled	ESC:Exit :Sel
Paging Mode Control	Closed	PgUp/PgDn:Modify
RAS-to-CAS	Default	F2/F3:Color

CAS Latency	Slow
RAS Timing	slow
RAS Precharge Timing	slow

2. Use <Up> and <Down> to choose the item and <PgUp> and <PgDn> keys to modify the highlighted item.
3. After you have finished with the Advanced Chipset Setup, press <ESC> to go back to the main menu.

Description of the item on screen follows:**USB Function**

Set this option to Enabled or Disabled the on-chip USB controller. The Optional and Fail-Safe default settings are Disabled.

USB Keyboard Legacy Support

Set this option to Enabled or Disabled USB keyboard. The Optional and Fail-Safe default settings are Disabled.

DRAM Page Closing Policy

This option controls whether the GMCH will precharge bank or precharge all, during the service of a page miss.

Memory Hole

This option allows the end user to specify the location of a memory hole. The cycle matching the selected memory hole will be passed to the ISA bus. If Enabled, the selected hole is not remapped.

DRAM Tras/Trc Cycle Time (SCLKs)

This option controls the number of SCLKs for an access cycle.

CAS# Latency

This option determines the CAS latency time parameter of SDRAM. The settings are 2 clks or 3 clks. Under 66MHz CPU bus, set this option to either 2 or 3 but for 100MHz CPU, it is recommended that this be set to 3.

SDRAM RAS# to CAS# Delay

This operation decide the delay in assertion of CAS#(SCAS#) from assertion of RAS#(SRAS#) in 66MHz. Under 66MHz CPU bus, set this option to either 2 or 3 but for 100MHz CPU, it is recommended that this be set to 3.

SDRAM RAS Precharge

This option defines the RAS# precharge requirements for the SDRAM memory type in 66MHz clocks. Under 66MHz CPU bus, set this option to either 2 or 3 but for 100MHz CPU, it is recommended that this be set to 3.

Graphics Mode Select

This option is used to enable/Disable the internal graphics device and select the amount of system memory that is used to support the internal graphics device.

Display Cache Window Size

This option determines the display cache window size. The settings are 64MB or 32MB.

Initialize Display Cache Memory

This option will allow you to initialize the display cache memory.

Paging Mode Control

This option decide if the GMCH memory controller will leave pages open or closed.

RAS-to-CAS

This option determine the display cache RAS#-toCAS# delay.

CAS# Latency

This option decide the display cache CAS latency.

RAS# Timing

This option controls RAS# active to precharge, and refresh to RAS# active delay.

RAS# Precharge Timing

This option controls RAS# precharge clocks.

4.5 Power Management Setup

1. Press <ENTER> on “Power Management Setup” of the main menu screen.

AMIBIOS SETUP - POWER MANAGEMENT SETUP		
(C) 1999 American Megatrends, Inc. All Rights Reserved		
ACPI Standby State	S1	Available Options:
Power Management/APM	Enabled	Disabled
Green PC LED Status	Blinking	Enabled
Green PC Monitor Power State	Stand By	
Video Power Down Mode	Suspend	
Hard Disk power Down Mode	Stand By	
Standby Time Out (Minute)	Disabled	
Suspend Time Out (Minute)	Disabled	
Throttle Slow Clock Ratio	50.0%	
Keyboard & PS/2 Mouse Access	Monitor	
FDC/LPT/COM Ports Access	Monitor	
SB & MSS Audio Ports Access	Ignore	
Midi Ports Access	Ignore	
ADLIB Ports Access	Ignore	
Primary Master IDE Access	Monitor	
Primary Slave IDE Access	Ignore	
Secondary Master IDE Access	Monitor	
Secondary Slave IDE Access	Ignore	
PIRQ[A] IRQ Active	Ignore	
PIRQ[B] IRQ Active	Ignore	
PIRQ[C] IRQ Active	Ignore	
PIRQ[D] IRQ Active	Ignore	
System Thermal	Ignore	
Thermal Slow Clock Ratio	50.0%	
CPU Critical Temperature	650C/1490F	
Power Button Function	On/Off	
Restore on AC/Power Loss	Last State	
Ring Resume from Soft Off	Disabled	ESC:Exit :Sel
LAN Resume from Soft Off	Disabled	PgUp/PgDn:Modify
PME Function Support	Disabled	F2/F3:Color

RTC Alarm Resume from Soft Off	Disabled
RTC Alarm Date	15
RTC Alarm Hour	12
RTC Alarm Minute	30
RTC Alarm Second	30

2. Use <Up> and <Down> to choose the item and <PgUp> and <PgDn> keys to modify the highlighted item.
3. After you have finished with the Power Management Setup, press <ESC> to go back to the main menu.

Description of the item on screen follows:**ACPI Standby State**

This option sets the ACPI Power Management Standby State.

Power Management/APM

Set this option to Enabled to enable the chipset's power management features and APM(Advanced Power Management). The settings are Enabled, Inst-On(instant-on) or Disabled. The Optimal and Fail-Safe default settings are Disabled.

Green PC LED Status

This option specifies the power state that the green PC-compliant video monitor enters when AMI® BIOS places it in a power savings state after the specified period of display inactivity has expired. The settings are Off, Standby, Suspend or Disabled. The Optimal and Fail-Safe default settings are Standby.

Green PC Monitor Power State

This option specifies the power state that the green PC-compliant video monitor enters when AMI® BIOS places it in a power savings state after the specified period of display inactivity has expired. The settings are Off, Standby, Suspend or Disabled. The Optimal and Fail-Safe default settings are Standby.

Video Power Down Mode

This option specifies the power conserving state that the VESA VGA video subsystem enters after the specified period of display inactivity has expired. The settings are Disabled, Standby or Suspend. The Optimal and Fail-Safe default settings are Standby.

Hard Disk Power Down Mode

This option specifies the power conserving state that the hard disk drive enters after the specified period of hard drive inactivity has expired. The settings are Disabled, Standby or Suspend. The Optimal and Fail-Safe default settings are Disabled.

Standby Time Out (Minute)

This option specifies the length of a period of system inactivity while in Standby state. When this length of time expires, the computer enters Suspend power state. The settings are Disabled, 1 min, 2 min, 3 min, 4 min, 5 min, 6 min, 7 min, 8 min, 9 min, 10 min, 11 min, 12 min, 13 min, 14 min or 15 min. The Optimal and Fail-Safe default settings are Disabled.

Suspend Time Out (Minute)

This option specifies the length of a period of system inactivity while in Standby state. When this length of time expires, the computer enters Suspend power state. The settings are Disabled, 1 min, 2 min, 3 min, 4 min, 5 min, 6 min, 7 min, 8 min, 9 min, 10 min, 11 min, 12 min, 13 min, 14 min or 15 min. The Optimal and Fail-Safe default settings are Disabled.

Throttle Slow Clock Ratio

This option specifies the speed at which the system clock runs in power saving states. The settings are expressed as a ratio between the normal CPU clock speed and the CPU clock speed when the computer is in the power-conserving state.

Thermal Slow Clock Ratio

When set to Monitor, then you can choose the throttle ratio. This option is connected with the **CPU Critical Temperature** Option.

CPU Critical Temperature

This option is for setting the CPU temperature that would be critical enough, so that it would use the Thermal Slow Clock Ratio to cool down the CPU.

Power Button Function

During Suspend, if you push the switch once, the system goes into suspend mode and if you push it more than 4 seconds, the system will be turned off. During On/Off, the system will turn off once you push the switch.

Restore on AC/Power Loss

The settings are power on or last status. During power on, after every AC power loss, the system will be turned on. During last status, after every AC power loss, whatever the system status, it will be the same when the AC power returns.

- Note:**
- a. If you set this option to last status, the Power Button Function must be set to On/Off, or this function will not work.
 - b. Jumper JP1 must always be open, for this function to work properly.

Ring Resume from Soft-Off

During Disabled, the system will ignore any incoming call from the modem. During Enabled, the system will boot up if there's an incoming call from the modem.

- Note:** If you have change the setting, you must let the system boot up until it goes to the operating system. Then, power off the system. This function will work the next time you power on.

LAN Resume from Soft-Off

During Disabled, the system will ignore any incoming signal from the LAN network card. During Enabled, the system will boot up if there's an incoming signal from the LAN network card.

- Note:** If you have change the setting, you must let the system boot up until it goes to the operating system. Then, power off the system. This function will work the next time you power on.

RTC Alarm Resume From Soft-Off

This function is for setting the Date, Hour, Minute, and Second for your computer to boot up. During Disabled, you cannot use this function. During Enabled, Choose the Date, Hour, Minute, and Second:

- RTC Alarm Date** Choose which day the system will boot up.
- RTC Alarm Hour** Choose which hour the system will boot up.
- RTC Alarm Minute** Choose which minute the system will boot up.
- RTC Alarm Second** Choose which second the system will boot up.

Note: If you have change the setting, you must let the system boot up until it goes to the operating system. Then, power off the system. This function will work the next time you power on.

4.6 PCI/Plug and Play Setup

1. Press <ENTER> on “PCI/Plug and Play Setup” of the main menu screen.

AMIBIOS SETUP - PCI/PLUG AND PLAY SETUP		
(C) 1999 American Megatrends, Inc. All Rights Reserved		
Plug and Play Aware O/S	No	Available Options:
Clear NVRAM	No	Enabled
PCI Latency Timer (PCI Clocks)	64	Disabled
Primary Graphics Adapter	Add-On	
PCI VGA Palette Snoop	Disabled	
DMA Channel 0	PnP	
DMA Channel 1	PnP	
DMA Channel 3	PnP	
DMA Channel 5	PnP	
DMA Channel 6	PnP	
DMA Channel 7	PnP	
IRQ3	PCI/PnP	
IRQ4	PCI/PnP	
IRQ5	PCI/PnP	
IRQ7	PCI/PnP	
IRQ9	PCI/PnP	
IRQ10	PCI/PnP	
IRQ11	PCI/PnP	
IRQ14	PCI/PnP	
IRQ15	PCI/PnP	
		ESC:Exit :Sel
		PgUp/PgDn:Modify
		F2/F3:Color

2. Use <Up> and <Down> to choose the item and <PgUp> and <PgDn> keys to modify the highlighted item.
3. After you have finished with the PCI/Plug and Play Setup, press <ESC> to go back to the main menu.

Description of the item on screen follows:

Plug and Play Aware O/S

Set this option to Yes if the operating system in this computer is aware of and follows the Plug and Play specification. The settings are Yes or No. The Optimal and Fail-Safe default settings No.

Clear NVRAM on Every Boot

During Yes, this will clear NVRAM data on every boot.

PCI Latency Timer (PCI Clocks)

This option specifies the latency timings (in PCI clocks) for all PCI devices on the PCI bus. The settings are 32, 64, 96, 128, 160, 192, 224 or 248. The Optimal and Fail-Safe default settings are 64.

Primary Graphics Adapter

This option is for selecting which VGA card is to be your primary display graphics adapter.

PCI VGA Palette Snoop

When this option is set to Enabled, multiple VGA devices operating on different buses can handle data from the CPU on each set of palette registers on every video device. Bit 5 of the command register in the PCI device configuration space is the VGA Palette Snoop bit (0 is disabled). For example, if there are two VGA devices in the computer (one PCI and ISA) and the Bit settings are:

Disabled-Data read and written by the CPU is only directed to the PCI VGA device's palette registers.

Enabled- Data read and written by the CPU is directed to both the PCI VGA device's palette registers and the ISA VGA device palette registers, permitting the palette registers of both devices to be identical.

This option must be set to Enabled if an ISA adapter card requires VGA palette snooping. The settings are Enabled or Disabled. The Optimal and Fail-Safe default settings are Disabled.

DMA Channel 0/1/3/5/6/7

These options specify the bus that the specified DMA channel is used. These options allow you to reserve DMAs for legacy ISA adapter cards.

These options determine if AMI® BIOS should remove a DMA from the available DMAs passed to devices that are configurable by the system BIOS. The available DMA pool is determined by reading the ESCD NVRAM. If more DMAs must be removed from the pool, the end user can use these options to reserve the DMA by assigning an ISA/EISA setting to it.

IRQ3/IRQ4/IRQ5/RQ7/IRQ9/IRQ10/IRQ11/IRQ14/IRQ15

These options specify the bus that the specified IRQ line is used on. These options allow you to reserve IRQs for legacy ISA adapter cards.

These options determine if AMI® BIOS should remove an IRQ from the pool of available IRQs passed to devices that are configurable by the system BIOS. The available IRQ pool is determined by reading the ESCD NVRAM. If more IRQs must be removed from the pool, the end user can use these options to reserve the IRQ by assigning an ISA/EISA setting to it. Onboard I/O is configured by AMI® BIOS. All IRQs used by onboard I/O are configured as PCI/PnP. If all IRQs are set to ISA/EISA and IRQ14 and 15 are allocated to the onboard PCI IDE, IRQ9 will still be available for PCI and PnP devices, because at least one IRQ must be available for PCI and PnP devices. The settings are ISA/EISA or PCI/PnP. The Optimal and Fail-Safe default settings are IRQ3 through 7 are ISA/EISA. The Optimal and Fail-Safe default settings PCI/PnP.

4.7 Peripheral Setup

1. Press <ENTER> on “Peripheral Setup” of the main menu screen.

AMIBIOS SETUP - PERIPHERAL SETUP		
(C) 1999 American Megatrends, Inc. All Rights Reserved		
CLKGEN Spread Spectrum	Enabled	Available Options:
CPU Ratio Selection	3.0x	Auto
CPU Host Clock (Mhz)	Auto	Disabled
Onboard Sound	Enabled	Enabled
Onboard AC'97 Audio	Enabled	
Onboard AC'97 Modem	Disabled	
Onboard IDE	Both	
Onboard FDC	Auto	
Onboard Serial Port A	Auto	
Onboard Serial Port B	Auto	
Serial Port B Mode	Normal	
IR Duplex Mode	Half Duplex	
IR Pin Select	IRRX/IRTX	
Onboard CIR Port	Disabled	
CIR IRQ Select	10	
Onboard Parallel Port	Auto	
Parallel Port Mode	ECP	
EPP Version	N/A	
Parallel Port IRQ	Auto	
Parallel Port DMA Channel	Auto	
Onboard Midi Port	Disabled	
Midi IRQ Select	9	ESC:Exit :Sel
Onboard Game Port	Disabled	PgUp/PgDn:Modify
Mouse PowerOn Function	Disabled	F2/F3:Color
Keyboard PowerOn Function	Disabled	
Specific Key for Power On	N/A	

2. Use <up> and <down> to choose the item and <PgUp> and <PgDn> keys to modify the highlighted item.
3. After you have finished with the Peripheral Setup, press <ESC> to go back to the main menu.

Description of the item on screen follows:**CLKGEN Spread Spectrum**

This item allows you to set the CPU clock generator spread spectrum.

CPU Ratio Selection

This item allows you to set the CPU ratio.

CPU Host Clock (MHz)

This item allows you to set the CPU host clock.

Onboard Sound

This item allows you to enable/disable the onboard Aureal audio chipset. The settings are Enabled, Disabled.

Onboard AC'97 Audio/Onboard AC'97 Modem

This item allows you to decide to enable/disable the 815 chipset family to support AC97 Audio/Modem. The settings are Enabled, Disabled.

Onboard IDE

Set this option to enable or disable on board IDE controller.

Onboard FDC

Choose Auto, for the BIOS to automatically detect the device

If the ISA add-on card has	Onboard FDC to be set at
FDC exist	Disabled
none FDC exist	Enabled

Choose Enabled, Enabling onboard FDC.

Choose Disabled, Disabling onboard FDC.

The Optimal and Fail-Safe default settings are Auto.

Onboard Serial Port A/Onboard Serial Port B

Choose 3F8, for the BIOS to automatically detect the device.

If the ISA add-on card has				Onboard Serial port to be set at			
COM1 (I/O:3F8H)	COM2 (I/O:3F8H)	COM3 (I/O:3E8H)	COM4 (I/O:2E8H)	PORT1	IRQ ASSIGNED	PORT2	IRQ ASSIGNED
✓	✓	✓	✓	DISABLED	X	DISABLED	X
✓	✓	X	X	COM3	4	COM4	3
X	X	✓	✓	COM1	4	COM2	3
✓	X	X	✓	COM2	3	COM3	4
X	✓	✓	X	COM1	4	COM4	3
✓	✓	✓	X	COM4	3	DISABLED	X
✓	✓	X	✓	COM3	4	DISABLED	X
✓	X	✓	✓	COM2	3	DISABLED	X
X	✓	✓	✓	COM1	4	DISABLED	X
X	X	X	X	COM1	4	COM2	3
✓	X	X	X	COM2	3	COM3	4
X	✓	X	X	COM1	4	COM3	4
X	X	✓	X	COM1	4	COM2	3
X	X	X	✓	COM1	4	COM2	3

Note: If the onboard serial port interrupt and ISA add-on card interrupt are in conflict, the serial port will not work properly. Please disable one of the devices.

Serial PortB Mode

Choosing Normal will set the Serial Port B for normal use, not for IR device. Choosing IrDA or Ask IR will set it for use with IR device using these protocols.

IR Duplex Mode

Can be set as either Half or Full duplex.

IR Pin Select

Set this option to IRRX/IRTX when using an internal IR device which is connected to IR1 connector.

Onboard Parallel Port

Choose Auto, the BIOS automatically assigned onboard parallel port to the available parallel port or disabled.

If the ISA add-on card has			Onboard parallel port to be set as	
LPT1 I/O:378H	LPT2 I/O:278H	LPT3 I/O:3BCH	PORT ASSIGNED	IRQ ASSIGNED
✓	✓	✓	Disabled	X
✓	✓	X	LPT3	5
✓	X	✓	LPT2	5
X	✓	✓	LPT1	7
✓	X	X	LPT2	5
X	✓	X	LPT1	7
X	X	✓	LPT1	7
X	X	X	LPT1	7

Note: *If the onboard parallel port interrupt and ISA add-on card interrupt are in conflict, the parallel port will not work properly. Please disable one of the devices.*

Parallel Port Mode

This option allows user to choose the operating mode of the onboard parallel port. The settings are Normal, SPP/EPP or ECP mode.

EPP Version

This option is for setting which EPP version will be used. The settings are 1.7 and 1.9.

Parallel Port IRQ

If the onboard parallel mode is not on auto mode, the user can select the interrupt line for onboard parallel port. We suggest that the user select the interrupt for the onboard parallel port as shown below:

Onboard parallel port set at	Parallel Port IRQ
LPT1(378H)	7
LPT2(278H)	5
LPT3(3BCH)	5

Parallel Port DMA Channel

This option allows user to choose DMA channel 1 to 3 for the onboard parallel port on ECP mode.

4.8 Hardware Monitor Setup (optional)

The Hardware Monitor Setup is used to set the CPU speed and monitor the current CPU Temperature, CPU Fan speed, Chassis Fan Speed, Power fan speed, Vcore, etc. This is only available if there is Hardware Monitor onboard.

1. Press <ENTER> on “Hardware Monitor Setup” of the main menu screen.

AMIBIOS SETUP - HARDWARE MONITOR SETUP		
(C) 1999 American Megatrends, Inc. All Rights Reserved		
Chassis Intrusion	Disabled	Available Options:
CPU Temperature Detected By	CPU	Manual
CPU Temperature	46°C/114°F	Auto
System Temperature	31°C/87°F	
CPU Fan Speed	4560 RPM	
Chassis Fan Speed	0 RPM	
Power Fan Speed	0 RPM	
CPU VID	2.00V	
Vcore	1.936V	
Vtt	2.480V	
Vio	3.280V	
+5,000V	5.113V	
+12,000V	12.045V	
-12,000V	-11.763V	
-5,000V	-4.932V	
Battery	3.00V	
+5V SB	5.60V	
		ESC:Exit :Sel
		PgUp/PgDn:Modify
		F2/F3:Color

2. Use <Up> and <Down> to choose the item and <PgUp> and <PgDn> keys to modify the highlighted item.
3. After you have finished with the PCI/Plug and Play Setup, press <ESC> to go back to the main menu.

Chapter 5

INTEL® 815 INTEGRATED GRAPHICS CONTROLLER

5.1 Overview

The Intel® 815 Chipset extends Intel's graphics capabilities into the value PC segment by incorporating 2D and 3D capabilities with the memory controller, to provide the industry with complete graphics offerings for every computing segment.

5.1.1 Intel® 815 Chipset

- Support 4MB Display Cache on AIMM card
- Support AGP 4X BUS
- 2D & 3D Graphics Accelerator

5.1.2 System Requirements

This section describes system requirements for the VGA Driver installation and Usage.

Computer	Intel® Celeron™/ Pentium® III (FC-PGA) processor or higher
Monitor	VGA Support, minimum 640x480 resolution
Operating system	DOS 5.0 or higher, Windows® 95/98, Windows® NT 3.51 or 4.0, or OS/2®
CD-ROM	Double Speed or Higher
Chipset	Intel® 815 chipset
VGA BIOS	Version 00.23 or Higher

5.2 Intel® 815 VGA Driver Setup & Usage Procedures

Insert the CD-title into your CD-ROM drive. This CD will auto-run. This will display installation for VGA driver and sound driver, Intel 815 INF Update (only for Windows 95/98) and Trend PC-cillin 98. Just click the button for automatic installation for VGA driver.

5.2.1 Windows® 95/98

If you start Windows® 95/98, this will automatically detect this hardware onboard “Standard PCI Graphics Adapter (VGA)”. You need to click “Next”, then “Finish”. Do not click on the “Cancel”. The driver need these ID.

Note: Before installing the Intel 815 VGA Driver, you need to install the Intel 815 INF update first.

5.2.1-1 Display Driver Installation Procedure:

Step 1: Insert the provided CD_ROM disk into the CD-ROM drive.

Step 2: Look for the CD_ROM drive, double click on the CD_ROM icon. This will show the setup screen.

Step 3: Click on “Intel 815 VGA Driver” icon.

Step 4: This will show an installation menu.

Step 5: Click on “Display Drivers”.

Step 6: Click “OK”.

Step 7: This will copy the VGA drivers into the hard drive.

Step 8: A message will appear stating you must restart the Windows® 95/98 system, select **yes** to restart.

Step 9: After restarting, Windows® 95/98 will show a new display setting.

5.2.2 Windows® NT 4.0

You need to install Windows® NT “Service Pack 3” or higher, before you install Windows® NT driver.

5.2.2-1 Display Driver Installation Procedure:

- Step 1:** Click **Start** menu and select **Control Panel** from **Settings** group.
- Step 2:** Select **Display** icon.
- Step 3:** Select **Settings** on the Display Properties.
- Step 4:** Select **Display Type**.
- Step 5:** Select **Change** from the **Adapter Type** Area.
- Step 6:** Select **Have Disk** of Change Display.
- Step 7:** Insert the **CD-Title Disk** into CD-ROM Drive.
- Step 8:** When the Install from Disk dialog box appears, look for your CD-ROM drive :**\\SVGA\Intel\815\NT4\WINNT4**
- Step 9:** When the **Change Display** dialog box appears, click **OK**.
- Step 10:** When the Third-party Drivers dialog box appears, click **Yes**.
A message will appear stating that the drivers were successfully installed. Click **OK**. You must now restart Windows® NT 4.0.

Note: You can also use CD autorun to install the VGA NT driver.

5.2.2-2 Changing resolution, color depth, and refresh rate:

- Step 1:** Click **Start** menu and select **Control Panel** from **Settings** group.
- Step 2:** Select **Display** icon.
- Step 3:** Select **Settings**.
- Step 4:** Select Color Palette to change between 256 color, 65536 colors, and 16777216 colors.
- Step 5:** To select desktop resolution size, go to the Desktop area and use the slide bar to change resolution from 640x480, 800x600, 1024x768, 1152x864, 1280x1024, to 1600x1200.
- Step 6:** Select Test to test the resolution. If the display test screen was good, then select Yes when the Testing Mode dialog box appears. If the display test screen was bad, then select No. Windows® NT will give you an error message.
- Step 7:** Click OK. If the display test screen was good and you select Yes, Windows® NT 4.0 will change the mode without restarting the system.

5.2.3 AutoCAD, OS/2 and other application. Please refer to “On-Line Manual” in the CD-ROM. You need to install the “Acrobat Reader 3.01” program first.

Chapter 6

CREATIVE AUDIO DRIVER (OPTIONAL)

6.1 Creative CT5880

The Creative® CT5880 digital controller provides the next generation of audio performance to the PC market

6.1.1 Features

- SoundScape WaveTable Synthesizer.
- Full DOS Game Compatibility.
- PCI Bus Master for fast DMA.
- Fully Compliant with PC97 Power Management Specification.

6.1.2 System Requirements

This section describes system requirements for the Audio Driver installation and Usage.

Computer	Intel® Pentium® II/III or Coppermine processor or higher
Operating system	DOS 5.0 or higher, Windows® 95, Windows® 98, Windows® NT 3.51 or 4.0, or OS/2®
CD-ROM	Double Speed or Higher
Chipset	Creative® CT5880

6.1.3 Audio Driver Setup

Insert the CD-title into your CD-ROM drive. This CD will auto-run. This will display installation for Microsoft DirectX7.0a, Creative Audio PCI Sound Drivers and Intel® chipset. Please make sure that you have finished the installation for Intel® Chipset Drivers before proceeding to install the Audio Driver. To install the audio driver, click on the button for automatic installation.

6.1.3-1 Windows® 95/98

If you start Windows® 95/98, this will automatically detect this hardware onboard “PCI Multimedia Audio Device” and “Gameport Joystick”. You need to click “Next”, then “Finish”. Do not click on the “Cancel”. The driver need these ID.

Audio Driver Installation Procedure:

- Step 1:** Insert the provided CD_ROM disk into the CD-ROM drive.
- Step 2:** Look for the CD_ROM drive, double click on the CD_ROM icon. This will show the setup screen.
- Step 3:** Click on “CREATIVE Audio PCI” sound drivers icon.
- Step 4:** This will copy the audio drivers into the hard drive.
- Step 5:** A message will appear stating you must restart the Windows® 95/98 system, select **yes** to restart.

Note: You must install Audio Driver before installing USB support.

6.1.3-2 Windows® NT 4.0

Audio Driver Installation Procedure:

- Step 1:** Click **Start** menu and select **Control Panel** from **Settings** group.
- Step 2:** Select **Multimedia** icon.
- Step 3:** Click on the **Devices** tab.
- Step 4:** Click **Add**.
- Step 5:** Double click on **Unlisted or Updated Driver** in the list.
- Step 6:** Insert the **CD-ROM Disk** into the CD-ROM Drive.
- Step 7:** When the Install from Disk dialog box appears, look for your CD-ROM drive: `:\Sound\Creative\AudioPCI\Audio\English\NT4drv`
- Step 8:** Click **OK**.
- Step 9:** Click **OK**.
- Step 10:** A message will appear stating that the drivers were successfully installed. Click **OK**. You must now restart Windows® NT 4.0.

6.1.4 Detailed User's Manual

The detailed user's manual can be found on following path of the CD-ROM provided:

PATH: Sound\Creative\AudioPCI\Docs\Manual.doc

Chapter 7

SIGMATEL AUDIO DRIVER (OPTIONAL)

7.1 Sigmatel 9721

Sigmatel 9721 is a general-purpose 18-bit stereo, full duplex, audio codec that conforms to the analog component specification of AC'97.

7.1.1 Features

- High performance 3D technology
- Energy saving power down modes
- 18-bit full duplex stereo ADC, DACs
- AC-Link protocol compliance
- Multiple power supply options
- Pin compatible with the STAC9704/07
- *SigmaTel Surround (SS3D)* Stereo Enhancement
- EAPD – External Amplifier Power Down Control
- Multi-Codec option (Intel AC'97 rev 2.1)
- Six analog line-level inputs
- 48-pin TQFP
- SNR > 95 dB through Mixer and DAC
- The STAC9723 is tested at +3.3V

7.1.2 System Requirements

This section describes system requirements for the Audio Driver installation and Usage.

Computer	Intel® Pentium® II/III or Coppermine processor or higher
Operating system	DOS 5.0 or higher, Windows® 95, Windows® 98, Windows® NT 3.51 or 4.0, or OS/2®
CD-ROM	Double Speed or Higher
Chipset	Sigmatel 9721

7.1.3 Audio Driver Setup

Insert the CD-title into your CD-ROM drive. This CD will auto-run. This will display installation for Microsoft DirectX7.0a, Creative Audio PCI Sound Drivers and Intel® chipset. Please make sure that you have finished the installation for Intel® Chipset Drivers before proceeding to install the Audio Driver. To install the audio driver, click on the button for automatic installation.

7.1.3-1 Windows® 95/98

If you start Windows® 95/98, this will automatically detect this hardware onboard “PCI Multimedia Audio Device” and “Gameport Joystick”. You need to click “Next”, then “Finish”. Do not click on the “Cancel”. The driver need these ID.

Audio Driver Installation Procedure:

- Step 1:** Insert the provided CD_ROM disk into the CD-ROM drive.
- Step 2:** Look for the CD_ROM drive, double click on the CD_ROM icon. This will show the setup screen.
- Step 3:** Click on “SigmaTel Sound Drivers” icon.
- Step 4:** This will copy the audio drivers into the hard drive.
- Step 5:** A message will appear stating you must restart the Windows® 95/98 system, select **yes** to restart.

Note: You must install Audio Driver before installing USB support.

7.1.3-2 Windows® NT 4.0**Audio Driver Installation Procedure:**

- Step 1:** Click **Start** menu and select **Control Panel** from **Settings** group.
- Step 2:** Select **Multimedia** icon.
- Step 3:** Click on the **Devices** tab.
- Step 4:** Click **Add**.
- Step 5:** Double click on **Unlisted or Updated Driver** in the list.
- Step 6:** Insert the **CD-ROM Disk** into the CD-ROM Drive.
- Step 7:** When the Install from Disk dialog box appears, look for your CD-ROM drive :**\Sound\Sigmatel\Driver\NT4**
- Step 8:** Click **OK**.
- Step 9:** Click **OK**.
- Step 10:** A message will appear stating that the drivers were successfully installed. Click **OK**. You must now restart Windows® NT 4.0.